



**PRISM MPI2-25 and MPX2-25
SDI / IP Waveform Monitor
User Manual**

Copyrights and Trademark Notices

Copyright © 2024 Telestream, LLC and its Affiliates. All rights reserved. TELESTREAM is a registered trademark of Telestream, LLC. All other trade names referenced are the service marks, trademarks, or registered trademarks of their respective companies.

Telestream products are covered by U.S. and foreign patents, issued and pending. Information in this publication supersedes that in all previously published material. Specifications and price change privileges reserved.

TELESTREAM is a registered trademark of Telestream, LLC.

Blender: Images from Big Buck Bunny used without modification under the Creative Commons Attribution 3.0 license. (c) copyright 2008, Blender Foundation (<http://peach.blender.org/about>).

Dolby: Dolby and the double-D symbol are registered trademarks of Dolby Laboratories.

Fraunhofer IIS and Thomson Multimedia. MPEG Layer-3 audio coding technology licensed from Fraunhofer IIS and Thomson Multimedia.

intoPIX and Fraunhofer. Notice under 35 U.S.C. §287(a): This product or service includes JPEG XS compliant features that are covered by patents in the United States and in other jurisdictions owned by intoPIX SA ("intoPIX") and/or Fraunhofer-Gesellschaft zur Förderung der angewandten Forschung E.V. ("Fraunhofer") and listed at <https://www.jpegxspool.com>. Additional patents may be pending in United States and elsewhere.

Warranty

Telestream on behalf of itself and its Affiliates ("Telestream") warrants that this product will be free from defects in materials and workmanship for a period of one (1) year from the date of shipment. If any such product proves defective during this warranty period, Telestream, at its option, either will repair the defective product without charge for parts and labor, or will provide a replacement in exchange for the defective product. Parts, modules and replacement products used by Telestream for warranty work may be new or reconditioned to like new performance. All replaced parts, modules and products become the property of Telestream.

In order to obtain service under this warranty, Customer must notify Telestream of the defect before the expiration of the warranty period and make suitable arrangements for the performance of service. Customer shall be responsible for packaging and shipping the defective product to the service center designated by Telestream, with shipping charges prepaid. Telestream shall pay for the return of the product to Customer if the shipment is to a location within the country in which the Telestream service center is located. Customer shall be responsible for paying all shipping charges, duties, taxes, and any other charges for products returned to any other locations.

This warranty shall not apply to any defect, failure or damage caused by improper use or improper or inadequate maintenance and care. Telestream shall not be obligated to furnish service under this warranty a) to repair damage resulting from attempts by

personnel other than Telestream representatives to install, repair or service the product; b) to repair damage resulting from improper use or connection to incompatible equipment; c) to repair any damage or malfunction caused by the use of non- Telestream supplies; or d) to service a product that has been modified or integrated with other products when the effect of such modification or integration increases the time or difficulty of servicing the product.

THIS WARRANTY IS GIVEN BY TELESTREAM WITH RESPECT TO THE PRODUCT IN LIEU OF ANY OTHER WARRANTIES, EXPRESS OR IMPLIED. TELESTREAM AND ITS VENDORS DISCLAIM ANY IMPLIED WARRANTIES OF MERCHANTABILITY OR FITNESS FOR A PARTICULAR PURPOSE. TELESTREAM'S RESPONSIBILITY TO REPAIR OR REPLACE DEFECTIVE PRODUCTS IS THE SOLE AND EXCLUSIVE REMEDY PROVIDED TO THE CUSTOMER FOR BREACH OF THIS WARRANTY. TELESTREAM AND ITS VENDORS WILL NOT BE LIABLE FOR ANY INDIRECT, SPECIAL, INCIDENTAL, OR CONSEQUENTIAL DAMAGES IRRESPECTIVE OF WHETHER TELESTREAM OR THE VENDOR HAS ADVANCE NOTICE OF THE POSSIBILITY OF SUCH DAMAGES.

[W2 – 15AUG04]

TELESTREAM SOFTWARE LICENSE AGREEMENT

THE PROGRAM, OR PROGRAMS, ENCODED OR INCORPORATED WITHIN EQUIPMENT OR ACCOMPANYING THIS AGREEMENT, IS FURNISHED SUBJECT TO THE TERMS AND CONDITIONS OF THIS AGREEMENT. RETENTION OF THE PROGRAM FOR MORE THAN THIRTY DAYS OR USE OF THE PROGRAM IN ANY MANNER WILL BE CONSIDERED ACCEPTANCE OF THE AGREEMENT TERMS. IF THESE TERMS ARE NOT ACCEPTABLE, THE UNUSED PROGRAM AND ANY ACCOMPANYING DOCUMENTATION SHOULD BE RETURNED PROMPTLY TO TELESTREAM FOR A FULL REFUND OF THE LICENSE FEE PAID. (FOR INFORMATION REGARDING THE RETURN OF PROGRAMS ENCODED OR INCORPORATED WITHIN EQUIPMENT, CONTACT THE NEAREST TELESTREAM SALES OFFICE.)

DEFINITIONS

"Telestream" means Telestream, LLC, a Delaware limited liability company, and its Affiliates, or the local Telestream legal entity that is supplying the equipment.

"Program" means the Telestream software product (executable program and/or data) enclosed with this Agreement or included within the equipment with which this Agreement is packed. "Customer" means the person or organization in whose name the Program was ordered.

LICENSE

Customer may:

1. Use the Program on a single machine at any one time; and
2. Copy the Program for archival or backup purposes, provided that no more than one (1) such copy is permitted to exist at any one time. Each copy of the Program made by Customer must include a reproduction of any copyright notice or restrictive rights legend appearing in or on the copy of the Program as received from Telestream.

Customer may not:

1. Use the Program on more than one machine at any one time;
2. Transfer the Program to any person or organization outside of Customer or the corporation of which Customer is a part without the prior written consent of Telestream, except in connection with the transfer of the equipment within which the programs are encoded or incorporated;
3. Export or re-export, directly or indirectly, the program, any associated documentation, or the direct product thereof, to any country to which such export or re-export is restricted by law or regulation of the United States or any foreign government having jurisdiction without the prior authorization, if required, of the Office of Export Administration, Department of Commerce, Washington, D.C. and the corresponding agency of such foreign government;
4. Modify the Program, create derivative works, or merge the Program with another program;
5. Reverse compile or disassemble the Program for any purpose, beyond the extent that such activity is expressly permitted by applicable open source licenses or applicable law notwithstanding this limitation; or
6. Copy the documentation accompanying the Program.

For Programs designed to reside on a single-machine and support one or more additional machines, either locally or remotely, without permitting the Program to be transferred to an additional machine for local execution, the additional machines shall be considered within the definition of "single machine." For programs permitting the Program to be transferred to an additional machine for local execution, a separate license shall be required for each such machine with which the Program may be used. Title to the Program and all copies thereof, but not the media on which the Program or copies may reside, shall be and remain with Telestream or others for whom Telestream has obtained a respective licensing right. Customer shall pay when due all property taxes that may now or hereafter be imposed, levied or assessed with respect to the possession or use of the Program or this license and shall file all reports required in connection with such taxes. If the Program or any related documentation is acquired by or for an agency of the U.S. Government, the Program and documentation shall be considered "commercial computer software" or "commercial computer software documentation" respectively, as those terms are used in 48 CFR §12.212, 48 CFR §227.7202, or 48 CFR §252.227-7014, and are licensed with only those rights as are granted to all other licensees as set forth in this Agreement.

THE PROGRAM MAY NOT BE USED, COPIED, MODIFIED, MERGED, OR TRANSFERRED TO ANOTHER EXCEPT AS EXPRESSLY PERMITTED BY THESE TERMS AND CONDITIONS. UPON TRANSFER OF ANY COPY, MODIFICATION, OR MERGED PORTION OF THE PROGRAM, THE LICENSE GRANTED HEREIN IS AUTOMATICALLY TERMINATED WITH RESPECT TO THE PARTY THAT TRANSFERS THE PROGRAM.

TERM

The license granted herein is effective upon acceptance by Customer, and shall remain in effect until terminated as provided herein. The license may be terminated by Customer at any time upon written notice to Telestream. The license may be

terminated by Telestream or any third party from whom Telestream may have obtained a respective licensing right if Customer fails to comply with any term or condition and such failure is not remedied within thirty (30) days after notice hereof from Telestream or such third party. Upon termination by either party, Customer shall return to Telestream or destroy, the Program and all associated documentation, together with all copies in any form.

LIMITED WARRANTY

The Program is provided "as is" without warranty of any kind, either express or implied. Telestream does not warrant that the functions contained in the Program will meet Customer's requirements or that the operation of the Program will be uninterrupted or error-free.

TELESTREAM AND ITS VENDORS DISCLAIM ANY IMPLIED WARRANTIES OF MERCHANTABILITY OR FITNESS FOR A PARTICULAR PURPOSE. LIMITATION OF LIABILITY, IN NO EVENT SHALL TELESTREAM OR OTHERS FROM WHOM TELESTREAM HAS OBTAINED A LICENSING RIGHT BE LIABLE FOR ANY INDIRECT, SPECIAL, INCIDENTAL, OR CONSEQUENTIAL DAMAGES ARISING OUT OF OR CONNECTED WITH CUSTOMER'S POSSESSION OR USE OF THE PROGRAM, EVEN IF TELESTREAM OR SUCH OTHERS HAS ADVANCE NOTICE OF THE POSSIBILITY OF SUCH DAMAGES.

THIRD-PARTY DISCLAIMER

Except as expressly agreed otherwise, third parties from whom Telestream may have obtained a licensing right do not warrant the program, do not assume any liability with respect to its use, and do not undertake to furnish any support or information relating thereto.

GENERAL

This Agreement contains the entire agreement between the parties with respect to the use, reproduction, and transfer of the Program. Neither this Agreement nor the license granted herein is assignable or transferable by Customer without the prior written consent of Telestream. This Agreement and the license granted herein shall be governed by the laws of the state of California. All questions regarding this Agreement or the license granted herein should be directed to the nearest Telestream Sales Office.

Important Compliance and Safety Information

United States of America Compliance Notices

Class A Interference Statement

This equipment has been tested and found to comply with the limits for a Class A digital device, pursuant to Part 15, Subpart B of the FCC Rules. These limits are designed to provide reasonable protection against harmful interference in a commercial installation. This equipment generates, uses, and can radiate radio frequency energy and, if not installed and used in accordance with the instructions, may cause harmful interference to radio communications. However, there is no guarantee that interference will not occur in a particular installation. Operation of this equipment in a residential area is likely to cause harmful interference in which the user will be required to correct the interference at the user's expense.

FCC Caution

This device complies with Part 15 of the FCC Rules. Operation is subject to the following two conditions:

1. This device may not cause harmful interference, and
2. This device must accept any interference received, including interference that may cause undesired operation.

Safety

UL 61010-1: 2012 R7.19: Safety Requirements for Electrical Equipment for Measurement, Control, and Laboratory Use - Part 1: General Requirements.

Environmental

Perchlorate Materials: this product contains one or more type CR lithium batteries. According to the state of California, CR lithium batteries are classified as perchlorate materials and require special handling.

See www.dtsc.ca.gov/hazardouswaste/perchlorate for additional information.

Canada Compliance Notices

Department of Communications Radio Interference Regulations

This digital apparatus does not exceed the Class A limits for radio-noise emissions from a digital apparatus as set out in the Radio Interference Regulations of the Canadian Department of Communications. This Class A digital apparatus complies with Canadian ICES-003.

Règlement sur le brouillage radioélectrique du Quadstere des Communications

Cet appareil numérique respecte les limites de bruits radioélectriques visant les appareils numériques de classe A prescrites dans le Règlement sur le brouillage radioélectrique du Quadstere des Communications du Canada. Cet appareil numérique de la Classe A est conforme à la norme NMB-003 du Canada.

Safety

CAN/CSA-C22.2 NO. 61010-1-12 + GI1 + GI2 (R2017) + A1: Safety Requirements for Electrical Equipment for Measurement, Control, and Laboratory Use - Part 1: General Requirements.

Sécurité

CAN/CSA-C22.2 NO. 61010-1-12 + GI1 + GI2 (R2017) + A1: Exigences de sécurité pour l'électricité Matériel de mesure, de contrôle et d'utilisation en laboratoire - Partie 1: Généralités Exigences.

European Union, European Free Trade Association (EFTA), and United Kingdom Compliance Notices

This equipment may be operated in the countries that comprise the member countries of the European Union and the European Free Trade Association. These countries, listed in the following paragraph, are referred to as The European Community throughout this document:

AUSTRIA, BELGIUM, BULGARIA, CYPRUS, CROATIA, CZECHIA, DENMARK, ESTONIA, FINLAND, FRANCE, GERMANY, GREECE, HUNGARY, IRELAND, ITALY, LATVIA, LITHUANIA, LUXEMBOURG, MALTA, NETHERLANDS, POLAND, PORTUGAL, ROMANIA, SLOVAKIA, SLOVENIA, SPAIN, SWEDEN, UNITED KINGDOM, ICELAND, LICHTENSTEIN, NORWAY, SWITZERLAND

Declaration of Conformity

Marking by the "CE" symbol indicates compliance with the Essential Requirements of the EMC Directive of the European Union 2014/30/EU

This equipment meets the following conformance standards:

Safety

EN 61010-1: 2010 + A1: Safety Requirements for Electrical Equipment for Measurement, Control, and Laboratory Use - Part 1: General Requirements Low Voltage Directive 2014/35/EU

Emissions

EN 55032: 2015 + A11: 2020, CISPR 32: 2015, EN 61000-3-2: 2014, EN 61000-3-3: 2013

Immunity

EN 55035: 2017, EN 61000-4-2: 2009,

EN 61000-4-3: 2006 + A1: 2008 + A2: 2010, EN 61000-4-4: 2012,

EN 61000-4-5: 2014 + A1: 2017, EN 61000-4-6: 2014, EN 61000-4-8: 2010,

EN 61000-4-11: 2020

Environments: E2

Warnings



Warning! This is a Class A product. In a domestic environment, this product may cause radio interference in which the user may be required to take appropriate measures.



Achtung! Dies ist ein Gerät der Funkstörgrenzwertklasse A. In Wohnbereichen können bei Betrieb dieses Gerätes Rundfunkstörungen auftreten, in welchen Fällen der Benutzer für entsprechende Gegenmaßnahmen verantwortlich ist.



Attention! Ceci est un produit de Classe A. Dans un environnement domestique, ce produit risque de créer des interférences radioélectriques, il appartiendra alors à l'utilisateur de prendre des mesures spécifiques appropriées.

Notes:

1. For Compliance with the EMC standards listed here, high-quality shielded interface cables should be used.
2. Emissions that exceed the levels required by this standard may occur when this equipment is connected to a test object.

Environmental Compliance

This section provides information about the environmental impact of the product.

Product End-of-Life Handling

Observe the following guidelines when recycling an instrument or component:

Equipment Recycling



Production of this equipment required the extraction and use of natural resources. The equipment may contain substances that could be harmful to the environment or human health if improperly handled at the product's end of life. To avoid release of

such substances into the environment and to reduce the use of natural resources, we encourage you to recycle this product in an appropriate system that will ensure that most of the materials are reused or recycled appropriately.

This symbol on the product or its packaging indicates that this product complies with the applicable European Union requirements according to Directives 2012/19/EU and 2006/66/EC on waste electrical and electronic - equipment (WEEE) and batteries.

It also indicates that this product must not be disposed of with your other household waste. Instead, it is your responsibility to dispose of your waste equipment by handing it over to a designated collection point for the recycling of waste electrical and electronic equipment. The separate collection and recycling of your waste equipment at the time of disposal will help conserve natural resources and ensure that it is recycled in a manner that protects human health and the environment. For more information about where you can drop off your waste for recycling, please contact your local authority, or where you purchased your product.

Battery Recycling

This product may contain a rechargeable battery, which must be recycled or disposed of properly. Please properly dispose of or recycle the battery according to local government regulations.

Transporting Batteries or Products with Batteries in them

The capacity of the lithium ion secondary battery shipped with this product is under 100 Wh. The lithium content of the installed primary battery is under 1 g. Each battery meets the applicable requirements of UN Manual of Tests and Criteria Part III Section 38.3. Battery quantity is under the limit for shipment according to Section II of the relevant Packing Instructions from the IATA Dangerous Goods Regulations. Consult your air carrier for applicability and determination of any special lithium battery transportation requirements.

Restriction of Hazardous Substances

This product is classified as an industrial monitoring and control instrument, and is required to comply with the substance restrictions of the RoHS 3 Directives 2011/65/EU and EU 2015/863.

Korea Compliance Statement

사 용 자 안 내 문
이 기기는 업무용 환경에서 사용할 목적으로 적합성평가를 받은 기기로서 가정용 환경에서 사용하는 경우 전파간섭의 우려가 있습니다.

Taiwan Compliance Statement

警告使用者：
這是甲類的資訊產品，在居住的環境中使用時，可能會造成射頻干擾，在這種情況下，使用者會被要求採取某些適當的對策。

This is a Class A product based on the standard of the Bureau of Standards, Metrology and Inspection (BSMI) CNS 13438, Class A. In a domestic environment this product may cause radio interference, in which case the user may be required to take adequate measures.

Japan Compliance Statement

この装置は、クラスA情報技術装置です。この装置を家庭環境で使用すると電波妨害を引き起こすことがあります。この場合には使用者が適切な対策を講ずるよう要求されることがあります。 VCCI-A

This is a Class A product based on the standard of the VCCI Council (VCCI 32: 2016). If this equipment is used in a domestic environment, radio interference may occur, in which case the user may be required to take corrective actions.

Important Safety Information

This manual contains information and warnings that must be followed by the user for safe operation and to keep the product in a safe condition. To safely perform service on this product, see the Service safety summary that follows the General safety summary.

General Safety Summary

Use the product only as specified. Review the following safety precautions to avoid injury and prevent damage to this product or any products connected to it. Carefully read all instructions. Retain these instructions for future reference.

Comply with Local and National Safety Codes

For correct and safe operation of the product, it is essential that you follow generally accepted safety procedures in addition to the safety precautions specified in this manual.

Product is Designed to be Used by Trained Personnel Only

Only qualified personnel who are aware of the hazards involved should remove the cover for repair, maintenance, or adjustment. Before use, always check the product with a known source to be sure it is operating correctly.

While using this product, you may need to access other parts of a larger system. Read the safety sections of the other component manuals for warnings and cautions related to operating the system.

When incorporating this equipment into a system, the safety of that system is the responsibility of the assembler of the system.

To Avoid Fire or Personal Injury

Use proper power cord: Use only the power cord specified for this product and certified for the country of use. Do not use the provided power cord for other products.

Ground the product: This product is grounded through the grounding conductor of the power cord. To avoid electric shock, the grounding conductor must be connected to earth ground. Before making connections to the input or output terminals of the product, ensure that the product is properly grounded. Do not disable the power cord grounding connection.

Power disconnect: The power cord disconnects the product from the power source. See instructions for the location. Do not position the equipment so that it is difficult to operate the power cord; it must remain accessible to the user at all times to allow for quick disconnection if needed.

Observe all terminal ratings: To avoid fire or shock hazard, observe all rating and markings on the product. Consult the product manual for further ratings information before making connections to the product. Do not apply a potential to any terminal, including the common terminal, that exceeds the maximum rating of that terminal.

Do not operate without covers: Do not operate this product with covers or panels removed, or with the case open. Hazardous voltage exposure is possible.

Avoid exposed circuitry: Do not touch exposed connections and components when power is present.

Do not operate with suspected failures: If you suspect that there is damage to this product, have it inspected by qualified service personnel.

Disable the product if it is damaged. Do not use the product if it is damaged or operates incorrectly. If in doubt about safety of the product, turn it off and disconnect the power cord. Clearly mark the product to prevent its further operation.

Before use, inspect voltage probes, test leads, and accessories for mechanical damage and replace when damaged. Do not use probes or test leads if they are damaged, if there is exposed metal, or if a wear indicator shows.

Examine the exterior of the product before you use it. Look for cracks or missing pieces.

Use Only Specified Replacement Parts

Do not operate in wet/damp conditions: Be aware that condensation may occur if a unit is moved from a cold to a warm environment.

Do not operate in an explosive atmosphere.

Keep product surfaces clean and dry: Remove the input signals before you clean the product.

Provide proper ventilation: Refer to the manual's installation instructions for details about installing the product so it has proper ventilation.

Slots and openings are provided for ventilation and should never be covered or otherwise obstructed. Do not push objects into any of the openings.

Provide a safe working environment: Always place the product in a location convenient for viewing the display and indicators.

Be sure your work area meets applicable ergonomic standards. Consult with an ergonomics professional to avoid stress injuries.

Use only the Telestream rack-mount hardware specified for this product.

Service Safety Summary

The Service safety summary section contains additional information required to safely perform service on the product. Only qualified personnel should perform service procedures. Read this Service safety summary and the General safety summary before performing any service procedures.

To avoid electric shock: Do not touch exposed connections.

Do not service alone: Do not perform internal service or adjustments of this product unless another person capable of rendering first aid and resuscitation is present.

Disconnect power: To avoid electric shock, switch off the product power and disconnect the power cord from the mains power before removing any covers or panels, or opening the case for servicing.

Use care when servicing with power on: Dangerous voltages or currents may exist in this product. Disconnect power, remove battery (if applicable), and disconnect test leads before removing protective panels, soldering, or replacing components.

Verify safety after repair: Always recheck ground continuity and mains dielectric strength after performing a repair.

Terms in the Manual

These terms may appear in this manual:



WARNING: Warning statements identify conditions or practices that could result in injury or loss of life.



CAUTION: Caution statements identify conditions or practices that could result in damage to this product or other property.

Terms on the Product

These terms may appear on the product:

DANGER indicates an injury hazard immediately accessible as you read the marking.

WARNING indicates an injury hazard not immediately accessible as you read the marking.

CAUTION indicates a hazard to property including the product.

Symbols on the Product

When this symbol is marked on the product, be sure to consult the manual to find out the nature of the potential hazards and any actions which have to be taken to avoid them. (This symbol may also be used to refer the user to ratings in the manual.)

The following symbol(s) may appear on the product:



General Safety Product Specific Statements

Use the product only as specified. Review the following safety precautions to avoid injury and prevent damage to this product or any products connected to it.

Carefully read all instructions. Retain these instructions for future reference.

Comply with local and national safety codes.

For correct and safe operation of the product, it is essential that you follow generally accepted safety procedures in addition to the safety precautions specified in this manual. The product is designed to be used by trained personnel only.

Only qualified personnel who are aware of the hazards involved should remove the cover for repair, maintenance, or adjustment.

Before use, always check the product with a known source to be sure it is operating correctly.

This product is not intended for detection of hazardous voltages.

Use personal protective equipment to prevent shock and arc blast injury where hazardous live conductors are exposed.

When incorporating this equipment into a system, the safety of that system is the responsibility of the assembler of the system.



WARNING: To avoid damaging your hearing, always turn the volume down to the minimum before you put on headphones and then turn the volume up slowly.



CAUTION: To reduce risk of fire and shock, use the certified power cord provided with the product.



CAUTION: To minimize the risk of damage to the instrument, we strongly recommend that the power cord be connected to the instrument before the power cord is connected to the AC power source



CAUTION: To prevent data loss, we strongly recommend you first shut down the instrument before disconnecting the power cord. Press the power button or select Settings, Utilities, Power, and then Power Down Now.



CAUTION: To prevent static damage to the SFP module, if you remove the SFP module from the instrument, always transport the SFP module in an anti-static bag or container.



CAUTION: To prevent possible damage to the PRISM monitor and SFP modules, remove the SFP modules before transporting the PRISM monitor.



CAUTION: After the instrument has started the upgrade process, DO NOT remove power from the instrument. If you do so, the instrument flash will be corrupted. The instrument will have to be sent to a Telestream factory service center to have the system firmware restored.



CAUTION: To prevent damage to the power cord or to the instrument power connector, do not attempt to disconnect the power cord by pulling on the cable. You must press the latch on the plug body, to disengage the locking mechanism, and pull the plug at the same time.



CAUTION: Uploading presets overwrites all existing presets in the PRISM.



CAUTION: Uploading presets overwrites all existing presets in the PRISM uploading the presets.



CAUTION: Removing the USB device or powering off the instrument before the upgrade is complete can cause upgrade failure. To prevent upgrade failure, wait until the Installation Complete message box is displayed before performing these actions.



CAUTION: IGMP communications can fail when the Video IP Ports are configured for the same IP Address.



CAUTION: Remote connectivity can be lost when the control port and either video port are on the same subnet. It is possible to lose remote connectivity while working locally and not know the connectivity was lost. For details about this problem and how to avoid it, see [Connect with VNC Client](#).

Preface

This manual contains information to help you use the PRISM SDI / IP Waveform Monitor:

- How to operate the instrument using the front panel, external mouse, keyboard, display, or remote connection.
- How to use the various applications for monitoring SDI or IP video signals.
- How to configure the instrument for network and remote access.
- How to set up error logging and alarms.

Where to Find More Information

The full User Manual, Release Notes, and other information about your product are available for download at www.telestream.net/video/resources.htm. The Product documentation table lists all the documentation for the PRISM SDI / IP Waveform Monitor.

Product documentation

Document	Manual type	Part number	Description
User Manual	Primary User	D00010019x	Provides detailed operating information.
Release Notes	Release Notes	D00010030x	Describes the new features, improvements, and limitations of the instrument firmware.
Installation and Safety Instructions	User	071373000x	Describes how to install a PRISM MPI2-25 instrument and provides basic safety and operating information (included with instrument).
	User	071373800x	Describes how to install a PRISM MPX2-25 instrument and provides basic safety and operating information (included with instrument).
PRISM MPI Dual Rack Cabinet Version 2 Installation Instructions	Field Install Instructions	071372500x	Describes how to install an MPI instrument in a 19" equipment rack using the optional MPI-RACK-MM or MPI-RACK-MW dual rack cabinet.

Product documentation

Document	Manual type	Part number	Description
Rackmount Slides and Rails Installation Instructions	Field Install Instructions	071370600x	Describes how to install an MPX instrument in a 19" equipment rack
PRISM MPI2-RACK-MD Installation and Safety Instructions	Field Install Instructions	071372800x	Provides installation and safety information for the PRISM MPI2-RACK-MD Rack Cabinet with touch display.
PRISM MPX2-DUALDSP Installation and Safety Instructions	Field Install Instructions	071372900x	Provides installation and safety information for the PRISM MPX2-DUALDSP Dual Display module.

Conventions Used in This Manual

The PRISM SDI / IP Waveform Monitor is also referred to as the "PRISM monitor" throughout this manual.

Telestream Contact Information

To obtain product information, technical support, or provide comments on this guide, contact us using our website, email, or phone number as listed below.

Resource	Contact Information
Telestream Video Support	Website: http://www.telestream.net/telestream-support Email: videosupport@telestream.net US and Canada Toll-free: 1-844-219-5329 Outside of US and Canada: 1-503-967-9833
Telestream	Website: www.telestream.net Sales and Marketing Email: info@telestream.net Telestream 848 Gold Flat Road, Suite 1 Nevada City, CA. USA 95959

Resource	Contact Information
International Distributor Support	Website: www.telestream.net See the Telestream website for your regional authorized Telestream distributor.
Telestream Technical Writers	Email: techwriter@telestream.net If you have comments or suggestions about improving this document, or other Telestream documents—or if you've discovered an error or omission, please email us.

Contents

- Important Compliance and Safety Information 6**
- Preface 16**
- Contents 19**
- Getting Started 21**
 - Product Description 21
 - Rack Mounting 27
 - MPI2-25 Power-on and Power-off Procedures 28
 - MPX2-25 Power-on and Power-off Procedures 31
 - SFP Module Installation 33
 - Network Installation 34
 - Managing Network Ports 36
 - MPI2-25 Rear Connectors 37
 - MPX2-25 Rear Panel Connectors 41
 - Display Elements 43
- Methods of Operation 50**
 - Touchscreen Operation 50
 - Select and Organize Applications 52
 - On-Screen Tools 57
 - Keyboard and Mouse Operation 58
 - MPX2-25 Front-panel Controls 59
 - Display Operation 61
 - Remote Control Operation 65
 - Camera Tally and UMD 73
- Configure the Instrument 78**
 - Configure and Select Virtual Inputs 78
 - Configure Instrument for HDR/WCG Monitoring 129
 - Using NMOS 130
 - Adjust Audio Settings 135
 - Configure Instrument Outputs 138
 - Configure to Decode Timecode 139
 - Configure Reference Settings 141
 - Configure and Recall Instrument Presets 144
 - Set Syslog Setup 154
 - SNMP Functionality 155
 - Alarms 158
 - Adjust Display 166
 - Configure Time and Date 173
 - Upgrade Instrument Firmware 175
 - Upgrade Software License 177

Troubleshooting	178
Functions	180
Headphone or Speaker Volume, Balance, Device, and Source Adjustment	180
Capture	184
Application Information	188
Application Options	188
Waveform Application	194
Vector Application	206
Lightning Application	213
Diamond Application	221
CIE Application	227
Stop Display Application	232
CAM Application	240
Picture Application	249
Video Session Application	264
Audio Application	270
Dolby Status Application	291
AES Channel Status Application	297
Event Log Application	298
IP Status Application	305
IP Session Application	308
IP Graphs Application	323
PIT Histogram Application	329
PTP Graphs Application	332
Stream Timing Application	335
ANC (Ancillary Data) Session Application	340
Datalist Application	343
Timing Application	345
Eye Application	349
Jitter Application	351
Audio-Video Delay Application	353
IP Generator and IP Display Applications	355
SDI Generator Application	365
PTP Operational Overview	368
PTP Introduction	368
Five Basic PTP Timing Messages	369
Profiles and Domains	370
One-Step and Two-Step Operation	371
Multicast, Unicast, and Mixed Communication Modes	371
BMCA Operation	373
Compensating for Causes of Asymmetric Delay	374
NMOS Specifications	376
NMOS Discovery Version 1.3	376

Getting Started

This chapter helps you set up and begin to use the PRISM SDI / IP Waveform Monitor.

Topics

- **Product description** describes the instrument and key features.
- **Controls and connectors** shows how to verify that you have received all of the parts of the instrument, lists standard and optional accessories, and lists options for the instrument.
- **Network installation** shows how to set up your instrument on an Ethernet network.

Product Description

The PRISM SDI / IP Waveform Monitor provides flexible options and field-installable upgrades to monitor a diverse variety of SDI and IP statistics as well as video and audio content. The comprehensive feature set, along with an intuitive and simplified graphical presentation of IP statistics, including video quality and diagnostic information, enables engineers to ensure the delivery of superior Quality of Service (QoS) levels in an increasingly complex broadcast environment involving compressed / uncompressed video transmission through SDI/IP signal paths. PRISM is an ideal solution for monitoring SDI/IP hybrid environments including master control rooms, production studios, OB vans, and signal contribution/distribution centers.

PRISM Model Form Factors

The PRISM SDI / IP Waveform Monitor is available in two form factors:

- **MPI2-25:** The PRISM MPI2-25 is 3RU half-rack width with integrated 9-inch HD display and touch panel. Option PHY is available to add physical layer measurement sets.



- **MPX2-25:** The PRISM MPX2-25 is 1RU full-rack width with optional integrated speakers. The MPX2-25 requires an external monitor or a remote connection, such as VNC. Option PHY is available to add physical layer measurement sets. Option RACK is required for rack mount.



Supported Formats

Supported SDI Formats

Link	Format	Sample Structure	Bits	Frame/Field rate	Option	
SD-SDI	525i	4:2:2	YCbCr	10b	59.94i	Base instrument
	625i	4:2:2	YCbCr	10b	50i	Base instrument
HD-SDI	1280x720	4:2:2	YCbCr	10b	23.98/24/25/ 29.97/30/50/ 59.94/60p	Base instrument
	1920x1080	4:2:2	YCbCr	10b	50/59.94/60i, 23.98/24/25/ 29.97/30p and psF	Base instrument
	2048x1080	4:2:2	YCbCr	10b	23.98/24/25/ 29.97/30p and psF	Base instrument
3G-SDI Level A	1920x1080	4:2:2	YCbCr	10b	50/59.94/60p	Base instrument
	1920x1080	4:4:4	RGB	10/12b	23.98/24/25/ 29.97/30p	MP2-PROD
	2048x1080	4:2:2	YCbCr	10b	47.95/48/50/ 59.94/60p	Base instrument
	2048x1080	4:4:4	RGB	10/12b	23.98/24/25/ 29.97/30p	MP2-PROD
3G-SDI Level B	1920x1080	4:2:2	YCbCr	10b	50/59.94/60p	Base instrument
	1920x1080	4:4:4	RGB	10/12b	23.98/24/25/ 29.97/30p	MP2-PROD
	2048x1080	4:2:2	YCbCr	10b	47.95/48/50/ 59.94/60p	Base instrument
	2048x1080	4:4:4	RGB	12b	23.98/24/25/ 29.97/30p	MP2-PROD

Supported SDI Formats

Link	Format	Sample Structure	Bits	Frame/Field rate	Option	
Quad Link HD-SDI Square Division	3840x2160	4:2:2	YCbCr	10b	23.98/24/25/ 29.97/30p, and psF	MP2-FMT-4K
	4096x2160	4:2:2	YCbCr	10b	23.98/24/25/ 29.97/30p	MP2-FMT-4K
Quad Link 3G-SDI Level A, Square Division	3840x2160	4:2:2	YCbCr	10b	50/59.94/60p	MP2-FMT-4K
	3840x2160	4:4:4	RGB	10/12b	23.98/24/25/ 29.97/30p	MP2-FMT-4K and MP2-PROD
	4096x2160	4:2:2	YCbCr	10b	47.95/48/50/ 59.94/60p	MP2-FMT-4K
	4096x2160	4:4:4	RGB	10/12b	23.98/24/25/ 29.97/30p	MP2-FMT-4K and MP2-PROD
Quad Link 3G-SDI Level B, Square Division	3840x2160	4:2:2	YCbCr	10b	50/59.94/60p	MP2-FMT-4K
	3840x2160	4:4:4	RGB	10/12b	23.98/24/25/ 29.97/30p	MP2-FMT-4K and MP2-PROD
	4096x2160	4:2:2	YCbCr	10b	47.95/48/50/ 59.94/60p	MP2-FMT-4K
	4096x2160	4:4:4	RGB	10/12b	23.98/24/25/ 29.97/30p	MP2-FMT-4K and MP2-PROD
Quad Link 3G-SDI Level A, Two Sample Interleave	3840x2160	4:2:2	YCbCr	10b	50/59.94/60p	MP2-FMT-4K
	3840x2160	4:4:4	RGB	10/12b	23.98/24/25/ 29.97/30p	MP2-FMT-4K and MP2-PROD
	4096x2160	4:2:2	YCbCr	10b	47.95/48/50/ 59.94/60p	MP2-FMT-4K
	4096x2160	4:4:4	RGB	10/12b	23.98/24/25/ 29.97/30p	MP2-FMT-4K and MP2-PROD
Quad Link 3G-SDI Level B, Two Sample Interleave	3840x2160	4:2:2	YCbCr	10b	50/59.94/60p	MP2-FMT-4K
	3840x2160	4:4:4	RGB	10/12b	23.98/24/25/ 29.97/30p	MP2-FMT-4K and MP2-PROD
	4096x2160	4:2:2	YCbCr	10b	47.95/48/50/ 59.94/60p	MP2-FMT-4K
	4096x2160	4:4:4	RGB	10/12b	23.98/24/25/ 29.97/30p	MP2-FMT-4K and MP2-PROD

Supported SDI Formats

Link	Format	Sample Structure	Bits	Frame/Field rate	Option	
6G-SDI	3840x2160	4:2:2	YCbCr	10b	23.98/24/25/ 29.97/30p	MP2-FMT-4K
	4096x2160	4:2:2	YCbCr	10b	23.98/24/25/ 29.97/30p	MP2-FMT-4K
12G-SDI	3840x2160	4:2:2	YCbCr	10b	50/59.94/60p	MP2-FMT-4K
	3840x2160	4:4:4	RGB	10/12b	23.98/24/25/ 29.97/30p	MP2-FMT-4K and MP2-PROD
	4096x2160	4:2:2	YCbCr	10b	47.95/48/50/ 59.94/60p	MP2-FMT-4K
	4096x2160	4:4:4	RGB	10/12b	23.98/24/25/ 29.97/30p	MP2-FMT-4K and MP2-PROD
Quad Link 12G-SDI	7680x4320	4:2:2	YCbCr	10b	50/59.94/60p	MP2-FMT-8K

Supported Video Formats in ST 2022-6 Streams

Link	Format	Sample Structure	Bits	Frame/Field rate	Option	
SD-SDI	525i	4:2:2	YCbCr	10b	59.94i	Base instrument
	625i	4:2:2	YCbCr	10b	50i	Base instrument
HD-SDI	1280x720	4:2:2	YCbCr	10b	23.98/24/25/29.97/30/50/59.94/ 60p	Base instrument
	1920x1080	4:2:2	YCbCr	10b	50/59.94/60i 23.98/24/25/29.97/30p, and psF	Base instrument
3G-SDI Level A	1920x1080	4:2:2	YCbCr	10b	50/59.94/60p	Base instrument
3G-SDI Level B	1920x1080	4:2:2	YCbCr	10b	50/59.94/60p	Base instrument

Supported Video Formats in ST 2110-20 Streams

Link	Format	Sample Structure	Bit	Frame/Field Rate	Option
2110-20	525i	4:2:2 YCbCr	10b	59.94i	Base instrument
	625i	4:2:2 YCbCr	10b	50i	Base instrument
	1280x720	4:2:2 YCbCr	10b	23.98/24/25/29.97/30/50/ 59.94/60p	Base instrument
	1920x1080	4:2:2 YCbCr	10b	50/59.94/60i	Base instrument
	1920x1080	4:2:2 YCbCr	10b	23.98/24/25/29.97/30/50/ 59.94/60p	Base instrument
	1920x1080	4:4:4 RGB	12b	23.98/24/25/29.97/30/50/ 59.94/60p	MP2-PROD
	2048x1080	4:2:2 YCbCr	10b	23.98/24/25/29.97/30/50/ 59.94/60p	Base instrument
	2048x1080	4:4:4 RGB	12b	23.98/24/25/29.97/30/50/ 59.94/60p	MP2-PROD
	3840x2160	4:2:2 YCbCr	10b	23.98/24/25/29.97/30/50p	MP2-FMT-4K
	3840x2160	4:2:2 YCbCr	10b	59.94/60p	MP2-FMT-4K and MP2-25GE
	3840x2160	4:4:4 RGB	12b	23.98/24/25/29.97/30p	MP2-FMT-4K and MP2-PROD
	4096x2160	4:2:2 YCbCr	10b	23.98/24/25/29.97/30/50p	MP2-FMT-4K
	4096x2160	4:2:2 YCbCr	10b	59.94/60p	MP2-FMT-4K and MP2-25GE
	4096x2160	4:4:4 RGB	12b	23.98/24/25/29.97/30p	MP2-FMT-4K, MP2-25GE, and MP2-PROD

Supported Video Formats for ST 2110-22

Link	Format	Sample Structure	Bits	Frame/Field Rate	Option
ST 2110-22	1280x720	4:2:2 YCbCr	10b	23.98/24/25/29.97/30p/ 50/59.94/60p	JPXS
	1920x1080	4:2:2 YCbCr	10b	23.98/24/25/29.97/30p, 50/59.94/60i, 50/59.94/60p	JPXS
	2048x1080	4:2:2 YCbCr	10b	23.98/24/25/29.97/30/50/ 59.94/60p	JPXS
	3840x2160	4:2:2 YCbCr	10b	23.98/24/25/29.97/30/ 50p/59.94/60p	JPXS and FMT-4K
	4096x2160	4:2:2 YCbCr	10b	23.98/24/25/29.97/30/ 50p/59.94/60p	JPXS and FMT-4K

ST 2110-30 and -31 Streams

Conformance level	Description
Conformance level A	Reception of 48-kHz streams with one to eight channels at packet times of 1 ms
Conformance level B	Reception of 48-kHz streams with one to eight channels at packet times of 1 ms or one to eight channels at packet times of 125 μs
Conformance level C	Reception of 48-kHz streams with one to 16 channels at packet times of 125 μs

Note: PRISM instruments with 25GE module have up to four ST 2110-30 streams of reception and up to 16 audio channels total.

Software Licenses

- MP2-25GE adds a node-locked license for 25GE support.
- MP2-IP-MEAS adds a node-locked license for IP Measurement feature sets, this includes IP/PTP Graph, IP/PTP Session, PIT Histogram, Timing, Stream Timing, and Stream capture applications.
- MP2-FMT-4K adds a node-locked license for 4K formats and enables 6G/12G-SDI.
- MP2-FMT-8K adds a node-locked license for 8K formats and enables 12G-SDI; 25GE upgrade kit is required for MPI2-10 and MPX2-10; MP2-FMT-4K is also required for 4K format support.

- MP2-AUD adds a node-locked license for enhanced audio feature sets, this includes Phase, Session, Correlation, Loudness, and Dolby E status display.
- MP2-DLBY adds a node-locked license for Dolby E, D, and D+ decoding. Also provides ED2 metadata in the Dolby Status application.
- MP2-ENG adds a node-locked license for baseband engineering feature sets, this includes Datalist, CC decode, and ANC Session.
- MP2-QC adds a node-locked license for quality control feature sets, this includes Datalist, CC decode, and ANC Session.
- MP2-PROD adds a node-locked license for production feature sets, this includes Stop, False Color, Light meter, HDR/WCG Conversion, Luma Qualified CIE, and HDR Measurements. It also adds support for deep color formats for both receiver and generator if the Option MP2-GEN is purchased.
- MP2-GEN adds a node-locked license for SDI/IP signal generator, this includes IP/SDI Generator application.
- MP2-EXTNDSP adds a node-locked license for enabling extended desktop.
- MP2-SRND adds a node-locked license for surround sound display.
- MPSPD-MULTI adds a node-locked license for SDI/IP (ST2110-20 or ST2110-22) multichannel input and Camera Alignment Monitoring.
- MPSPD-JPXS adds a node-locked license for decoding of ST 2110-22 JPEG XS streams.

Rack Mounting

There are several options to mount the PRISM models in racks.

MPI2-25 Monitor

There are two optional dual rack cabinets (19-inch, 3RU) for the PRISM monitor. Each cabinet kit includes the *PRISM MPI Dual Rack Cabinet and Extender Installation Instructions* document (part number 071-3725-xx).

MPI-RACK-MM

Allows you to install one MPI unit or two MPI units side-by-side. Each side of the cabinet front panel has two USB ports and a headphone port for each MPI unit.

MPI-RACK-MW

Allows you to install one MPI unit or one MPI unit in a side-by-side installation with a WFM52x0, WFM7200, WFM8x00 waveform monitor. The left side of the cabinet front panel has two USB ports and a headphone port for one MPI unit.

Dual Rack Cabinet Versions

There are two versions of the instructions for the MPI-RACK-MM and MPI-RACK-MW dual rack cabinets:

PRISM Dual Rack Cabinet Documentation

Document	Part Number	Description
PRISM MPI Dual Rack Cabinet Version 1 Installation Instructions	071-3501-xx (English)	In version 1 of the instructions, the MPI-RACK-MM and MPI-RACK-MW cabinets are the same size.
PRISM MPI Dual Rack Cabinet Version 2 Installation Instructions	071-3725-00x (English)	In the second version of the instructions, the MPI-RACK-MW cabinet comes with a removable extender installed that makes it longer than the MPI-RACK-MM cabinet.

MPX2-25 Monitor

For the PRISM MPX2-25 monitor, you can use the optional MPX2-25 RACK 1RU full-rack kit for portable or rack-mount applications. The MPX2-25 RACK allows you to install one PRISM 1RU full width MPX2-25 RACK. The MPX2-25 RACK rack-mounting kit includes the *Rack Mounting Slides and Rails Kit Installation Instructions* document (part number 071-3706-xx).

Dual-Display Monitors

The following rack-mounted dual-display monitors are available for MPI2 and MPX2 to extend the PRISM display to a second HD monitor:

- **MPI2-RACK-MD:** Allows you to install one PRISM MPI2 monitor (not included) next to an external HD display in a 3RU full width rack. A software license is required to enable the extended display feature. For information on how to install and use this extended display, see the *PRISM MPI2-RACK-MD Installation and Safety Instructions*.
- **MPX2-DUALDSP:** Allows you to connect an MPX2 to a 3RU full rack width dual display assembly to serve as a compact primary and extended desktop display system for the MPX2. A software license is required to enable the extended display feature. For information on how to install and use this extended display, see the *PRISM MPX2-DUALDSP Installation and Safety Instructions*.

MPI2-25 Power-on and Power-off Procedures

This section describes how to apply power to the MPI2-25 monitor and how to power-on and power-off the instrument.

International Power Cords

The instrument was shipped with one of the following power cord options. Power cords for use in North America are UL listed and CSA certified. Cords for use outside North America are approved by at least one authority acceptable in the country to which the product is shipped.

- PWR-CORD-NA-S15 – North America Power Cord
- PWR-CORD-EURO – Universal EUR power cord
- PWR-CORD-CHN – China power cord
- PWR-CORD-IN – India power cord
- PWR-CORD-UK – United Kingdom power cord
- PWR-CORD-BRZ – Brazil power cord
- PWR-CORD-AUS – Australia power cord
- PWR-CORD-CHE – Switzerland power cord
- PWR-CORD-JPN – Japan power cord
- PWR-CORD-NONE – No power cord or AC Adapter



CAUTION: To reduce risk of fire and shock, use the certified power cord provided with the product.

MPI2-25 Power Cord Installation

This instrument is powered by an AC power source. Connect the power cord to the power connector on the rear panel of the instrument.

The power connector is keyed to be directional, with the flat portion of the power cord housing facing the left of the instrument (as viewed from the rear). When fully inserted, the power cord housing latches onto the instrument power connector.



CAUTION: To minimize the risk of damage to the instrument, we strongly recommend connecting the power cord to the instrument before connecting the power cord to the AC power source.

MPI2-25 Power Cord Removal

The power cord housing latches on the instrument power connector when fully inserted. To remove the power cord, grasp the connector housing, as shown, and firmly pull the cord away from the instrument.



CAUTION: To prevent damage to the power cord or to the instrument power connector, do not attempt to disconnect the power cord by pulling on the cable. You must pull on the connector housing to disengage the locking mechanism.

CAUTION: To minimize the risk of damage to the instrument, we strongly recommend disconnecting the power cord from the AC power source before disconnecting the power cord from the instrument.

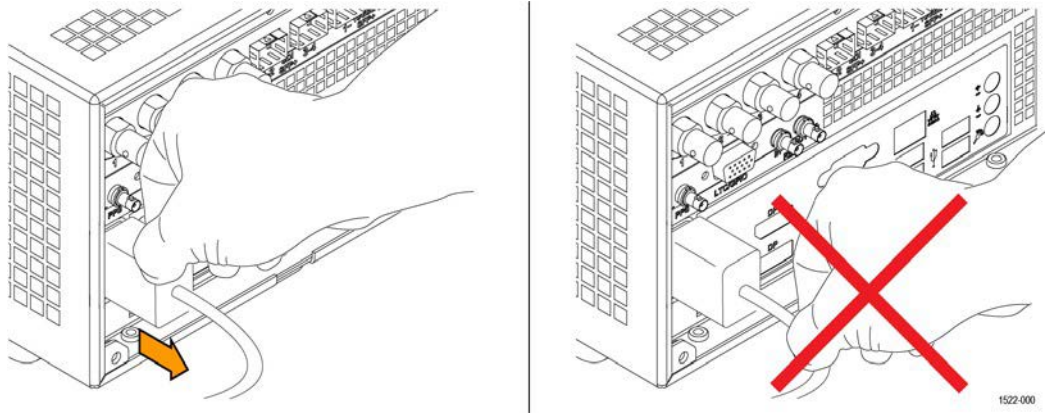

MPI2-25 Power-on Procedure

1. Connect power to the instrument. (See [MPI2-25 Power Cord Installation](#).)

Note: If the PRISM monitor was previously powered off by a power interruption or by disconnecting the power cord from the rear of the instrument, the instrument powers on when power is reconnected.

2. To turn on the instrument, press the power button on the instrument front panel.

Note: In normal operation, the MPI2-25 power button turns red during the power-on sequence, then turns white, and then turns off.



MPI2-25 Power-off Procedure

1. Press the power button on the instrument front panel to turn the instrument off.
Or in the instrument:
 - A. Select **Settings**.
 - B. Select **Utilities**.
 - C. Select **Power**.
 - D. Select **Power Down Now**.



CAUTION: To prevent data loss, we strongly recommend you first shut down the instrument before disconnecting the power cord. Press the power button or select Settings, Utilities, Power, and then Power Down Now.

2. To completely remove power from the instrument, disconnect the power cord from the AC power source and then disconnect the power cord from the instrument.
(See [MPI2-25 Power Cord Removal](#).)

MPX2-25 Power-on and Power-off Procedures

This section describes how to apply power to the MPX2-25 monitor and how to power-on and power-off the instrument.

International power cords

Your instrument was shipped with one of the following power cord options. Power cords for use in North America are UL-listed and CSA-certified. Cords for use outside North America are approved by at least one authority acceptable in the country to which the product is shipped.

- PWR-CORD-NA-S15 – North America Power Cord
- PWR-CORD-EURO – Universal EUR power cord
- PWR-CORD-CHN – China power cord
- PWR-CORD-IN – India power cord
- PWR-CORD-UK – United Kingdom power cord
- PWR-CORD-BRZ – Brazil power cord
- PWR-CORD-AUS – Australia power cord
- PWR-CORD-CHE – Switzerland power cord
- PWR-CORD-JPN – Japan power cord
- PWR-CORD-NONE – No power cord or AC Adapter

 **CAUTION: To reduce risk of fire and shock, use the certified power cord provided with the product.**

MPX2-25 Power Cord Installation

This instrument is powered by an AC power source. Connect the power cord to the power connector on the rear panel of the instrument.

The power connector is keyed to be directional, with the flat portion of the power cord housing facing the left of the instrument (as viewed from the rear). When fully inserted, the power cord housing latches onto the instrument power connector.

 **CAUTION: To minimize the risk of damage to the instrument, we strongly recommend connecting the power cord to the instrument before connecting the power cord to the AC power source.**

MPX2-25 Power-on Procedure

1. Apply power to the instrument. (See [MPX2-25 Power Cord Installation](#).)

Note: If the PRISM monitor was previously powered off by a power interruption or by removing the power cord from the rear of the instrument, the instrument powers on when power is reapplied.

2. To turn the instrument on, press the power button on the instrument front panel.

Note: In normal operation, the MPX power button turns red during the power-on sequence and turns green and remains green.



MPX2-25 Power-off Procedure

1. Press the power button on the instrument front panel to turn the instrument off.
Or in the instrument:
 - A. Select **Settings**.
 - B. Select **Utilities**.
 - C. Select **Power**.

D. Select **Power Down Now**.



CAUTION: To prevent data loss, we strongly recommend you first shut down the instrument before disconnecting the power cord. Press the power button or select Settings, Utilities, Power, and then Power Down Now.

2. To completely remove power from the instrument, disconnect the power cord from the AC power source and then disconnect the power cord from the instrument.

SFP Module Installation

There are several types of optional SFP modules available:

- MP-SFP 10GESR is a 10G Ethernet short-range SFP+ transceiver (850 nm).
 - MP-SFP 10GELR is a 10G Ethernet long-range SFP+ transceiver (1310 nm).
 - MP-SFP 25GESR is a 25G Ethernet short-range SFP28 transceiver (850 nm).
 - MP-SFP 25GELR is a 25G Ethernet long-range SFP28 transceiver (1310 nm).
-

Note: ST 2022-7 requires two 10GE (or 25GE) SFP modules to be installed. The modules must be installed in SFP ports 1 and 2.

Install SFP Module

To install an SFP module, insert the SFP module into the SFP connector. The module latches into place when fully inserted.

Note: There are different types of SFP modules for 10GE and 25GE signals. If the SFP module does not match the unit signal setting (for example, a 25GE SFP module is installed and the unit is set for a 10GE signal), the Link Status (in Network, under Settings) returns "SFP Error."

To remove the SFP module, pull down on the latch and then pull the module out of the SFP connector.

Note: Different types of SFP modules may have different latching mechanisms. The 10GE, 25GE, and SDI SFP connectors are marked on the back of the MPI2-25 (see [MPI2-25 Rear Connectors](#)) and MPX2-25 (see [MPX2-25 Rear Panel Connectors](#)).

SFP Module Transportation

CAUTION: To prevent static damage to the SFP module, if you remove the SFP module from the instrument, always store and transport the SFP module in an anti-static bag or container.

CAUTION: To prevent possible damage to the PRISM monitor and SFP modules, remove the SFP modules before transporting the PRISM monitor.

Note: QSFP modules are not supported.

Network Installation

See the installation and safety instructions manual that shipped with the instrument for basic installation instructions. After the instrument is physically installed, you might want to connect it directly to a PC or to a network. This section explains how.

Connect Directly to a PC

1. Connect the instrument directly to a PC with an Ethernet cable. You can also use an Ethernet Switch.
2. Set up the instrument as shown.

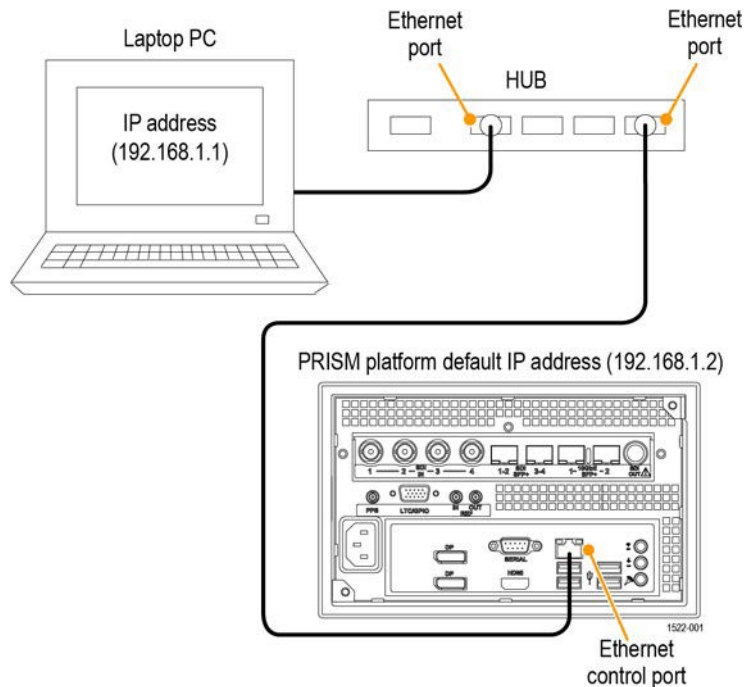

3. Choose Manual IP mode to set the IP address manually. Be sure to set an address that is compatible with the setting of your PC.

Note: The default IP address of the PRISM monitor is 192.168.1.2.

Connect to a Network

To allow network access to the instrument, you must set the IP address. Network addresses can be assigned automatically (DHCP) or manually. If your network does not use DHCP, you must manually enter the address for the instrument. To get a fixed address, talk to your LAN administrator. The default IP address of the PRISM monitor is 192.168.1.2.



CAUTION: Remote connectivity can be lost when the control port and either video port are on the same subnet. It is possible to lose remote connectivity while working locally and not know the connectivity was lost. For details about this problem and how to avoid it, see [Connect with VNC Client](#).

To connect the instrument to a network and access it with a remote PC:

1. On the PRISM monitor, select the **Settings** icon ()
2. Select **Network** to open the Network submenu.
3. Select **CONTROL IP PORT**.
4. Depending on your local network requirements, select **DHCP** or **Manual** to select the method for selecting an IP address.



CAUTION: If you select **Manual**, remote access can be lost if the addresses are not known and correct. Local access is required to select **DHCP** to reconnect remote access.

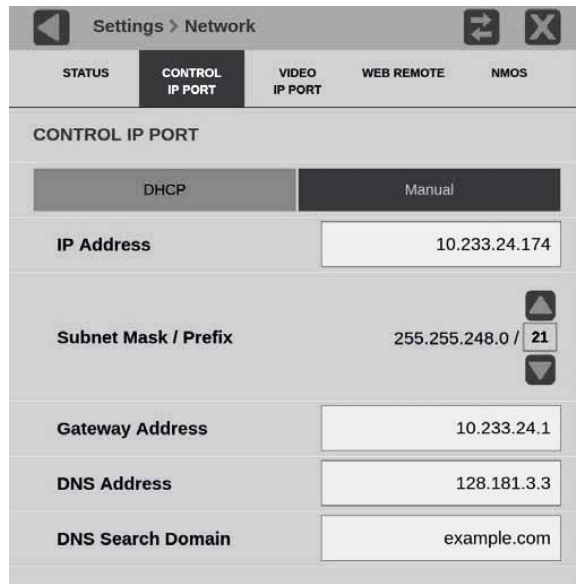

5. If you cannot use DHCP and you selected Manual, use the Manual submenu to set the IP address, subnet mask, gateway address, DNS address, and DNS Search Domain parameters you obtained from your LAN administrator. (Be sure to use compatible addresses between the PC and the instrument.)
6. In the **IP Address** box, type or select the IP input address.

 **CAUTION: IGMP communications can fail when the Video IP Ports are configured for the same IP Address.**

7. Select the **Close** icon (⌵).

Managing Network Ports

Network ports are virtual connections on networked devices, such as the MPS, MPD, and MPP products, which allow data to be sent or received. These products require a number of network ports to be open for proper operation.

Required Network Ports

Port Type	Port	Function
TCP	22	SSH
TCP	80	HTTP
TCP	5900	VNC server
TCP	6080	
TCP	8080	Web server

Required Network Ports

Port Type	Port	Function
TCP	8999	
TCP	9000	
UDP	161-162	SNMP
UDP	5004-5005	RTSP
UDP	30000-60000	Web RTC ¹

1. Not all models support WebRTC. See [Remote Control through WebRTC](#) for a list of supported models.

Consult with your network administrator to ensure that these ports are available.

MPI2-25 Rear Connectors

The following figure shows the external connections on the rear panel of the MPI2-25 instrument. A description of each connector is provided.

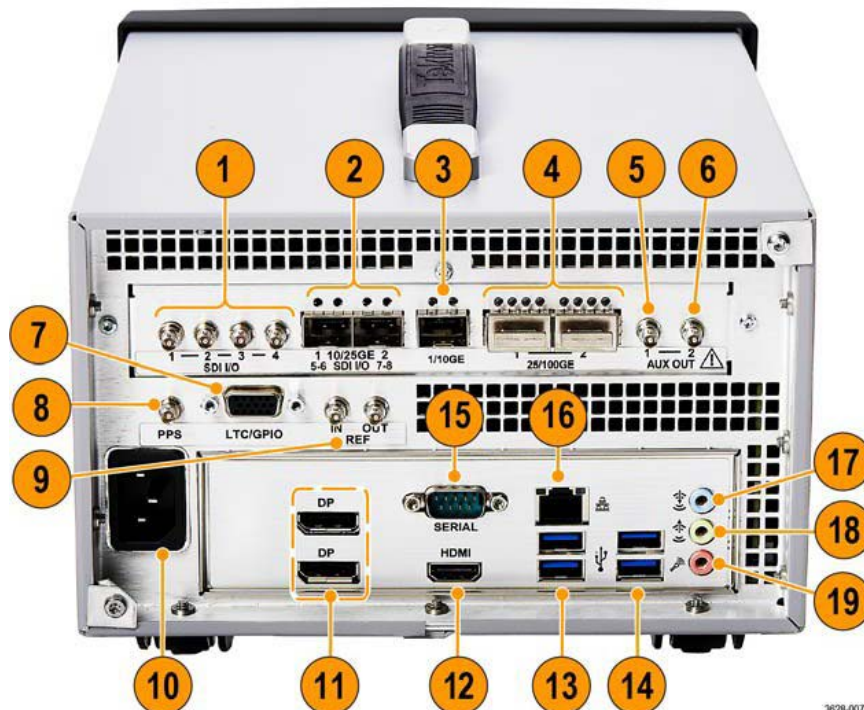





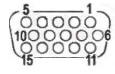

3628-007

Descriptions of Numbered PRISM MPI2-25 Rear-Panel Connectors

Item Number	Connector Label, Symbol, or End	Description
1	SDI I/O	<p>Four HD-BNC inputs can operate in four modes:</p> <ul style="list-style-type: none"> • SDI inputs 1-4 support SD/HD/3G/6G/12G signals. • Single SDI link (Option MP2-FMT-4K is required for 6G/12G support), when used as a single link, only one of the SDI 1-4 inputs is active at a time. • Quad 4K links, when used in conjunction with the SDI 1-4 inputs (Option MP2-FMT-4K only). When used as Quad 4K links, all four SDI inputs are active. • Eye diagram is up to 12G on SDI input 1 only for physical layer measurements, including automated measurement of 12G-SDI eye pattern parameters (requires Options MP2-FMT-4K and PHY).
2	10/25GE SDI I/O	<p>Two SFP module slots can be configured for SDI or IP applications.</p> <ul style="list-style-type: none"> • 10/25GE: Two optional SFP+ ports are for 10/25GE Ethernet applications. See MP-SFP products for available modules. • SDI I/O: Two optional SFP+ ports for future functionality.
3	1/10GE	SFP IP port is for future functionality.
4	25/100GE	Two QSFP28 ports are for future functionality.
5	AUX OUT 1	<p>AUX OUT is for SDI output of the selected SDI, ST 2022, or 2110 input; or it is an SDI generator output (GEN license is required):</p> <ul style="list-style-type: none"> • For quad link inputs (4K or 8K) the AUX OUT 1 is link 1. • ST2110-20/22/30/31 inputs are supported.
6	AUX OUT 2	<p>AUX OUT is for SDI output of the selected SDI, ST 2022, or 2110 input; or it is an SDI generator output (GEN license is required):</p> <ul style="list-style-type: none"> • For quad link inputs (4K or 8K) the AUX OUT 2 is link 1. • ST2110-20/22/30/31 inputs are supported.
7	LTC/GPIO 	<p>LTC/GPIO is a 15-pin, micro D-sub connector; see LTC/GPIO Remote Connector Pin Assignments and Preset Functions.</p>
8	PPS	PPS connector outputs a 1 PPS (pulse per second) signal when the instrument is locked to a PTP reference. 3.3v drive. TTL compatible.
9	REF IN – OUT	REF IN is used for analog reference signals black burst and trilevel sync for locking. REF OUT is a pass-through of the REF IN.
10	AC In	Connector for an AC power source.

Descriptions of Numbered PRISM MPI2-25 Rear-Panel Connectors

Item Number	Connector Label, Symbol, or End	Description
11	DP	Two DisplayPort outputs are for external monitors. The output video format is 1920×1080. ¹ Note: An MPI2-25 can use one external display, DP or HDMI. A DP port can be used to mirror or extend the front panel display. For details about using a display in extended mode, see Configure MPI2 Extended Display .
12	HDMI	HDMI port output is for an external monitor. The output video format is 1920×1080. ¹ Note: An MPI2-25 can use one external display, DP or HDMI. The HDMI port can only be used to mirror the front panel display.
13		Two USB 3.0 ports are for connecting a mouse and keyboard, importing or exporting instrument presets, upgrading the instrument firmware, or saving screen and stream captures.
14		Two USB 3.0 ports are for connecting a mouse and keyboard, importing or exporting instrument presets, upgrading the instrument firmware, or saving screen and stream captures.
15	SERIAL 	Serial interface, nine-pin connector, is not used.
16		Ethernet port is a standard RJ-45 connector for 10/100/1000Base-T Ethernet cable.
17		Audio input port is for future use.
18		Audio output (1/8-inch—3.5mm—line out) port is for headphones to listen to the selected audio channel pair. ²
19		Microphone input port is for future use.

¹ When connecting to an external monitor, a monitor with a 1920×1080-capable display works best with the instrument.

² Audio output is an 1/8-inch (3.5mm) diameter port for a headset. It has connections for L and R audio channels. Headset plugs that are an 1/8-inch and have an additional contact for a microphone might not work because the headphone ports are not set for the spacing requirements of a third connection on the plug.

LTC/GPIO Remote Connector Pin Assignments and Preset Functions

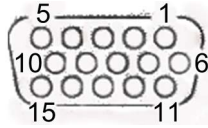
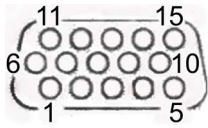
Characteristic	Pin Function
MPI2-25 Connector Pin Assignments	1 GND 2 Do not connect 3 Do not connect 4 Do not connect 5 Do not connect 6 GND
	
MPX2-25 Connector Pin Assignments	7 Do not connect 8 Do not connect 9 Do not connect 10 Preset A1 recall ¹ 11 Preset A2 recall ¹ 12 Preset A3 recall ¹ 13 Preset A4 recall ¹ 14 Preset A5 recall ¹ 15 Preset A6 recall ¹
	

1. Active low inputs, internally pulled up to 5 V. A 5 V tolerant open drain or open collector driver, are recommended.

Note: The MPX2-25 GPIO is inverted compared to standard use. The pin functions are the same, but the numbering begins in the lower left.

Recall Preset through GPIO

Ground and release the pin related to the preset (for example, pin 10 for preset A1) to a ground (pin 1 or 6). The GPIO must be turned on:

1. Select the **Settings** icon (), select **Utilities** and then select **GPIO**.
2. Set **Preset Recall** to **On**.

Or through API:

At the API command line, to turn the GPIO recall on, send:

`GPIO_PRESET_RECALL_ENABLE_ON`

To turn the GPIO recall off, send:



`GPIO_PRESET_RECALL_ENABLE_OFF`

MPX2-25 Rear Panel Connectors

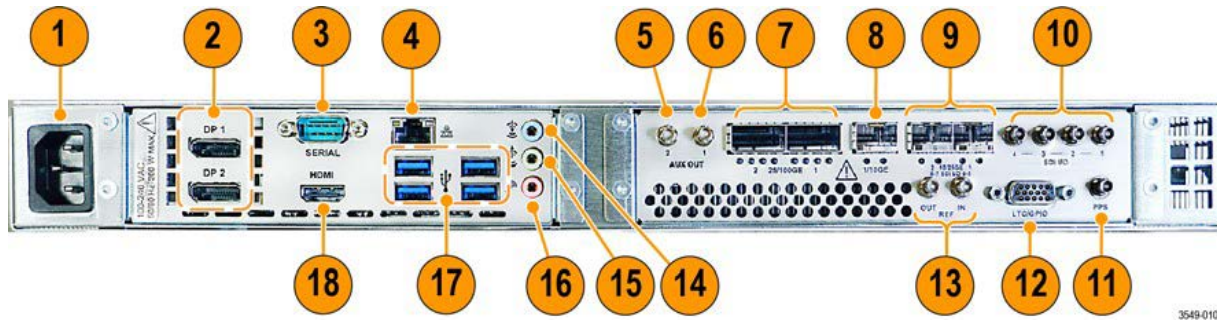



The following figure shows the external connections on the rear panel of the MPX2-25 instrument. A description of each connector is provided. See [MPX2-25 Front-panel Controls](#) for information about the front panel connectors.

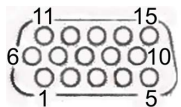

Descriptions of Numbered PRISM MPX2-25 Rear-panel Connectors

Item Number	Connector Label, Symbol, or End	Description
1	AC In	Connector is for an AC power source.
2	DP	Two DisplayPort outputs are for external monitors. The output video format is 1920x1080. ¹ Note: An MPX2-25 can use up to two external displays, DP or HDMI. For details about using two displays in extended mode, see Extended Display Mode .
3		Serial interface, nine-pin connector, is not used.
4		Ethernet port is a standard RJ-45 connector for 10/100/1000Base-T Ethernet cable.
5	AUX OUT 2	SDI output of the selected SDI, ST 2022, or 2110 input: <ul style="list-style-type: none"> • Quad link inputs (4k/8k) the Aux out is link 1 • ST 2110-20/22/30/31 inputs are supported.
6	AUX OUT 1	SDI output of the selected SDI, ST 2022, or 2110 input: <ul style="list-style-type: none"> • Quad link inputs (4k/8k) the Aux out is link 1 • ST 2110-20/22/30/31 inputs are supported.
7	25/100GE	Two QSFP28 ports are for future functionality.
8	1/10GE	SFP+ IP port is for future functionality.

Descriptions of Numbered PRISM MPX2-25 Rear-panel Connectors

Item Number	Connector Label, Symbol, or End	Description
9	10/25GE SDI I/O	Two SFP+ module slots can be configured for SDI or IP applications. <ul style="list-style-type: none"> • 10/25GE: Two optional SFP+ ports are for 10/25GE Ethernet applications. See MP-SFP products for available modules. • SDI I/O: Two optional SFP+ ports for future functionality.
10	SDI I/O	Four HD-BNC inputs can operate in four modes: <ul style="list-style-type: none"> • SDI inputs 1-4 support SD/HD/3G/6G/12G signals. • Single SDI link (Option MP2-FMT-4K is required for 6G/12G support), when used as a single link, only one of the SDI 1-4 inputs is active at a time. • Quad 4K links, when used in conjunction with the SDI 1-4 inputs (Option MP2-FMT-4K only). When used as Quad 4K links, all four SDI inputs are active. • Quad 8K links, when used in conjunction with the SDI 1-4 inputs (Option MP2-FMT-8K only). When used as Quad 8K links, all four SDI inputs are active. • Eye diagram is up to 12G on SDI input 1 only for physical layer measurements, including automated measurement of 12G-SDI eye pattern parameters (requires Options MP2-FMT-4K and PHY).
11	PPS	PPS connector outputs a 1 PPS (pulse per second) signal when the instrument is locked to a PTP reference. 3.3v drive. TTL compatible.
12	LTC/GPIO 	LTC/GPIO is a 15-pin, micro D-sub connector; see LTC/GPIO Remote Connector Pin Assignments and Preset Functions . Note: The GPIO in the MPX2-25 is inverted compared to standard use. The pin functions are the same but the numbering begins in the lower left.
13	REF IN – OUT	REF IN is used for analog reference signals black burst and trilevel sync for locking. REF OUT is a pass-through of the REF IN.
14		Audio input port is for future use.
15		Audio output (1/8-inch—3.5mm—line out) port is for headphones to listen to the selected audio channel pair. ²
16		Microphone input port is for future use.

Descriptions of Numbered PRISM MPX2-25 Rear-panel Connectors

Item Number	Connector Label, Symbol, or End	Description
17		Four USB 3.0 ports are for connecting a mouse and keyboard, importing or exporting instrument presets, upgrading the instrument firmware, or saving screen and stream captures.
18	HDMI	HDMI port output is for an external monitor. The output video format is 1920×1080. ¹ Note: An MPX2-25 can use a maximum of two external displays, DP or HDMI. For details about using two displays in extended mode, see Extended Display Mode .







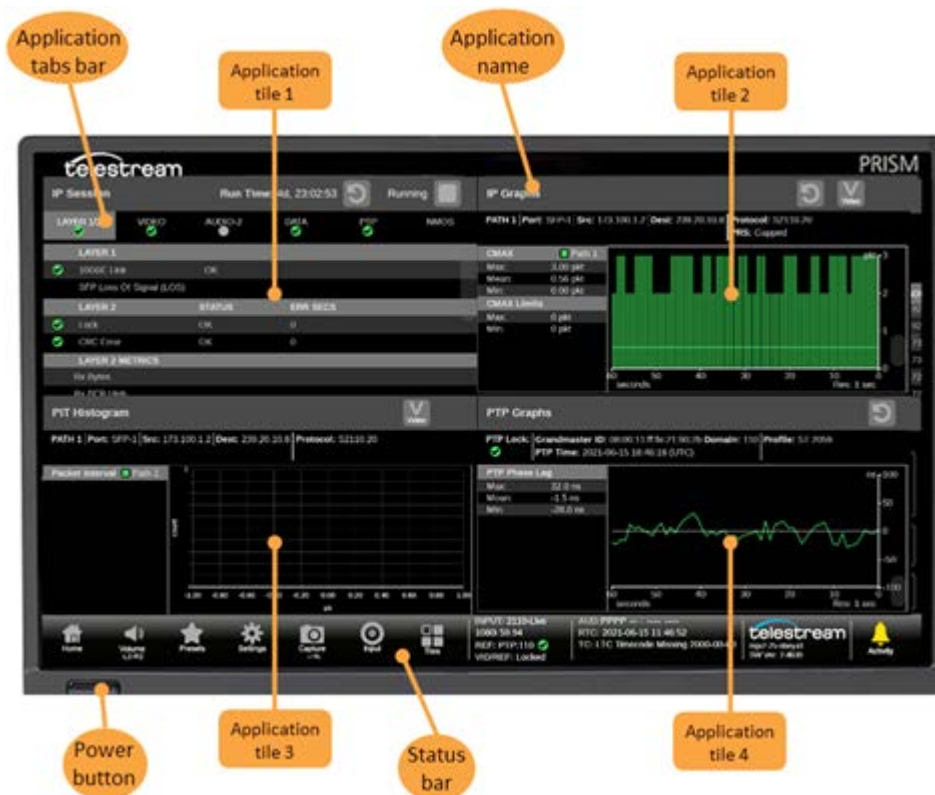

- 1 When connecting to an external monitor, a monitor with a 1920×1080-capable display works best with the instrument.
- 2 Audio output is an 1/8-inch (3.5mm) diameter port for a headset. It has connections for L and R audio channels. Headset plugs that are an 1/8-inch and have an additional contact for a microphone might not work because the headphone ports are not set for the spacing requirements of a third connection on the plug.

Display Elements

The following figure shows the key elements of the MPI2-25 internal monitor.



Descriptions of Numbered PRISM MPI2-25 Display Elements

Item Number	Description
Applications Tabs Bar	Some applications have selectable tabs (highlighted readouts) you can use to display additional information.
Application Tiles 1-4	Location of the application tile ¹
Application Name	Lists the name of the displayed application.
Power Button	Press the button to turn the instrument on or off. To completely remove power from the instrument, remove the power cord.
 CAUTION: To prevent data loss, we strongly recommend you shut down the instrument before disconnecting the power cord. Press the power button or select Settings, Utilities, Power, and then Power Down Now.	
Status Bar	<p>The left side of the status bar has icons with links to various instrument settings including Volume () , Presets () , Settings () , Input type () , and the Tile application menu () . Select the Home icon () to exit any displayed menus.</p> <p>The right side of the status bar lists instrument status such as the selected input, type of input signal, selected signal reference, video/reference signal status, audio channel status, the real-time clock or PTP clock (to switch between the clocks, see Configure Time and Date), and a link to the Activity menu () .</p> <p>Note: When an instrument setting is selected, the associated menu replaces the status bar.</p>

¹ The applications tiles can be in quarter-screen display, half-screen display, or one application in full-screen display.

Activity Center

The Activity center tracks messages and devices in the PRISM. For example, you can view messages that allow you to eject devices mounted to the instrument. These steps explain how to eject a USB drive from the instrument using the Activity center.



A number above the Activity icon indicates the number of messages waiting in and devices connected to the instrument. The instrument can use USBs formatted to FAT32.



1. Select the **Activity** icon to view the DASHBOARD messages, which include devices connected to the instrument.

Note: After you insert a USB drive, you must unmount it via the **Activity** icon before removing it from the instrument.

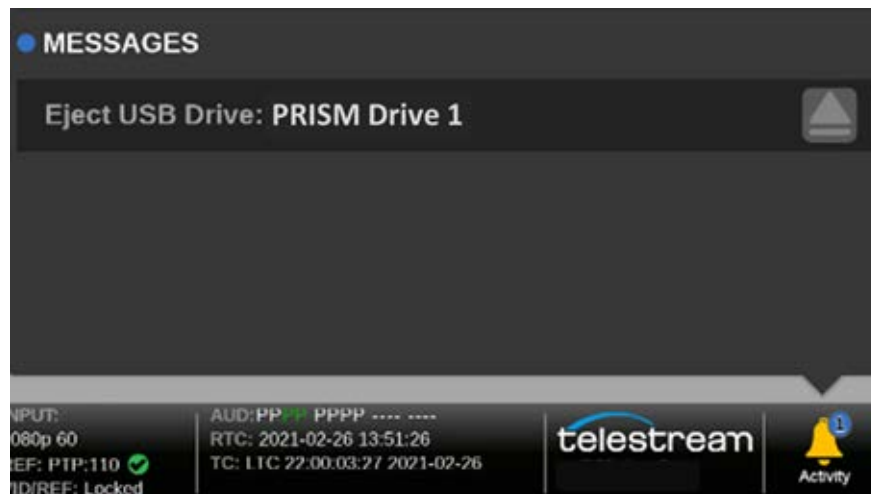

2. Select the **Eject** icon (🗑️) to unmount the USB drive from the instrument.

Note: If there is no USB drives in the instrument, the Eject USB Drive text and eject icon do not appear.

3. Select the **Activity** icon (🔔) again to close the window.

Monitor Alarms

The Activity DASHBOARD, in the status bar, provides a user-configurable alarm notification system. This allows the user to be only notified of the alarms of interest.

To configure which alarms you receive notifications for, select the **Settings** menu and then select **Alarm**.

The Activity icon is color-coded:

- A gray icon means no alarms have been activated.



- A yellow icon means at least one alarm was activated, but it has cleared.



- A red icon means at least one alarm is currently activated.

Note: Active alarms take precedence over cleared alarms. If there are cleared alarms and active alarms, the icon is red.



Use Activity DASHBOARD

To open the closed Activity DASHBOARD, select the **Activity** icon (🔔).

To close the open Activity DASHBOARD, select the **Activity** icon (🔔).



The alarm group buttons and the alarm titles are color-coded.

- The Group buttons (ANC Session, Audio, etc.) color coding:
 - A gray button means no alarms in the group are turned on in the DASHBOARD.
 - A green button means at least one alarm in the group is turned on but no alarms are active.
 - A yellow button means at least one alarm in the group has been activated but it has cleared.

- A red button means at least one alarm in the group has been activated and it is still active.

Note: A red (still active) alarm takes precedence over yellow. If there are both active and cleared alarms in the group, the button is red.

- The alarm titles (under the group buttons) color coding:
 - A white title means the alarm is *not* turned on in the DASHBOARD.
 - A green title means the alarm is turned on in the DASHBOARD and the alarm is not active.
 - A yellow title means the alarm was activated but it has cleared.
 - A red title means the alarm was activated and it is still active.

Turn Alarms On or Off in DASHBOARD

Note: Turning alarms off means they are not tracked in the DASHBOARD or through the Activity icon. No color change or alarm occurs. The alarms are still logged in the Event Log application and sent to the Syslog server, if enabled.

1. In the status bar, select the **Settings** icon and then select **Alarms**.
2. Select the alarms to turn on in the DASHBOARD.
 - To turn on a group or groups of alarms in the DASHBOARD, select the checkbox of any alarm group.
 - To turn an alarm group off, clear the checkbox.

	Threshold	Dashboard
ANC Session		<input checked="" type="checkbox"/>
Audio		<input checked="" type="checkbox"/>
CC / Subtitles		<input type="checkbox"/>
Gamut		<input checked="" type="checkbox"/>
HDR		<input checked="" type="checkbox"/>
IP		<input type="checkbox"/>
Timing		<input checked="" type="checkbox"/>
Video Session		<input checked="" type="checkbox"/>

- To turn on any specific alarm or alarms, select the title of a group of alarms to see the individual alarms and select the checkbox of any specific alarm.

- To turn an alarm off, clear the checkbox.



- To set the thresholds for alarms (an alarm with N/A under Threshold does not have thresholds to set), select anywhere in the alarm line and select the up or down arrows to change the threshold settings.



Acknowledge Alarm Notifications

The notification of alarms can be acknowledged (set the alarms to green) through two methods in the Activity DASHBOARD:

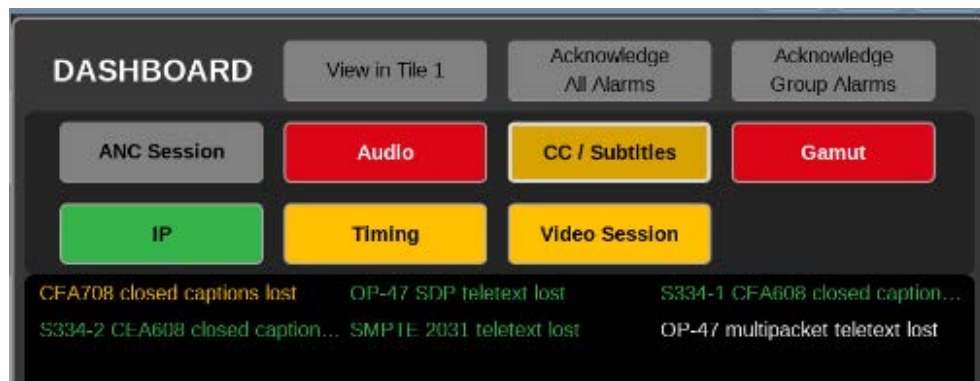

- To acknowledge all the alarms in the DASHBOARD, at the top of the DASHBOARD, select **Acknowledge Alarms**. All the alarms and all the group buttons are set to green unless an alarm is still asserted, in that case the alarm, and the related group button, remains red.
- To acknowledge all of the alarms in the selected alarm group, at the top of the DASHBOARD, select **Acknowledge Group**. All the alarms in the selected group and the group button are set to green, unless an alarm is still asserted, in that case the alarm, and the related group button, remains red.

Use Alarm Groups

Alarm groups allow sorting alarms for easier checking and clearing. They can also be sorted by group in Event Log.

Choose Alarm Group

Select the group button from the options below the DASHBOARD header (ANC Session, Audio, etc.). The alarm group is circled in white and the alarms in that group appear below the group buttons.

See Alarms in Event Log Application

Select **View in tile 1** at the top of the DASHBOARD.

- The Event Log application displays in tile 1.
- The errors are filtered by the group currently selected Dashboard Alarm Group.

Filter Event Log Alarms by Group

Select an alarm group and select **View in tile 1**.

Methods of Operation

This chapter describes the primary methods of operating the instrument.

Topics

- [Touchscreen Operation](#)
- [Select and Organize Applications](#)
- [On-Screen Tools](#)
- [Keyboard and Mouse Operation](#)
- [MPX2-25 Front-panel Controls](#)
- [Display Operation](#)
- [Remote Control Operation](#)
- [Camera Tally and UMD](#)

Touchscreen Operation

This section explains how to set up a second touchscreen display and how to use the touchscreens with the applications. The following figure shows the PRISM display in four-tile mode with the All Applications Menu open.

Note: Your available applications depend on the model of PRISM you have and the options installed.



Supported Touchscreen Gestures

Use these touchscreen gestures to control the instrument:

- Touch or tap the screen to select display elements.
- Double-tap an application to change the display between a quarter-screen and a full-screen display or between a half-screen tile and a full-screen display of the selected application. Double-tap a full-screen display to return to the quarter- or half-screen tile.
- Swipe up or down, or left or right as necessary to move through menus and preset listings and to view additional application information.
- Some applications support pinch and zoom.

Note: The terms “tap,” “swipe,” and “pinch” apply to the touchscreen on the instrument. If you are using a mouse and keyboard you must “click,” “scroll,” and use the scroll wheel on the mouse.

Touchscreen Feedback

To see where you have touched on a monitor (only in touchscreen enabled monitors), you can activate an on-screen marker.

To turn on the Touch Indicator:

1. Select the **Settings** icon ().
2. Select **Utilities** and select **Touch Settings**.
3. In the Touch Indicator section, select the size: **Dot**, **Small**, **Med**, or **Large**.

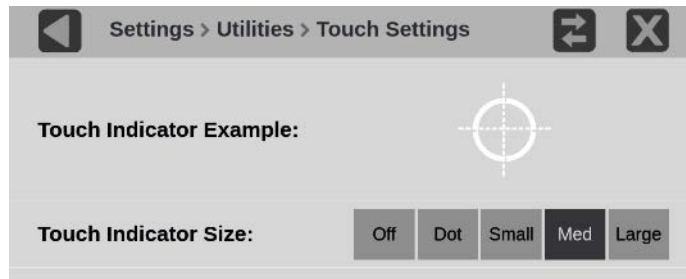

To turn off the Touch Indicator, select **Off** in the **Touch Indicator Size** section.

Select and Organize Applications

To open a different application in a tile:

1. In the status bar, select the **Tiles** icon () to open the Application menu, shown.



Note: You can include up to eight application icons in the Applications toolbar, in any order.

2. Select a tile to replace with a different application.
3. Select an application from the application bar.
4. If an application is not on the application bar, select the **All Applications** menu icon (), on the right of the application bar.
5. Select the new application from the **All Applications** menu.



Note: The applications in the All Applications menu depend on what options were purchased.

Change Applications in Application Menu

1. In the **All Applications** menu, select **Edit** from the menu header.
 - Select an application marked with a number to remove it from the application bar.

Note: Removed applications leave that space open in the application bar only while the menu is in edit mode. If there is a space in the application list when the changes are saved, the applications are consolidated on the left and any spaces are moved to the right.

- Select **Clear All** to remove all the applications from the application bar.
- Select an application that is not marked with a number to add it to an empty space in the application bar.

Note: The applications are added to the Applications menu from the left. If the number 1 and 2 spaces are empty, the next selected application is added to the number 1 space.

2. Select **Save** in the All Applications menu. If you do not save the changes (if you select the **Close** icon (✕) before saving), a warning appears asking if you want to save the changes. Select **Ok** to save the changes or **Cancel** to close the All Applications menu and return the application bar to the layout before you selected Edit.
3. Select the **Close** icon (✕).

Access Application Settings Menu

1. Select the tile with the application.
2. Select the **Tiles** icon (🗑️) on the left of the application bar.
3. Select the **Tile** icon (⚙️). The application Settings menu is displayed.

Change Design of Interface (Two Options)

On the Tiles menu and the All Applications menu, you can view application icons in color or gray scale. For easier visibility, you can modify the highlight color for the selected application and the selected tile.

Turn Color of Application Icons On or Off

You can enable or disable color for applications in the All Applications menu and the applications bar.

1. Select the **Tiles** icon (🗪) and then select the **All Applications** menu icon (🗪).
2. In the All Applications menu header, select the **Colored Icons** button to change the icon colors on or off.

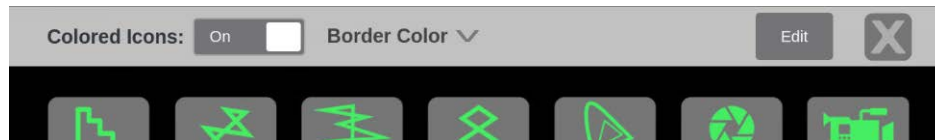

Change Selected Application Border Color

1. Select the **Tiles** icon (🗪) and then select the **All Applications Menu** icon (🗪).
2. In the All Applications menu header, select **Border Color**.
3. Select **Blue**, **White**, or **Yellow**. The border of any selected tile is highlighted in the chosen color.

Manage Tile Display

Based on your requirements, you can display each application quarter-screen, half-screen, or full-screen. The default for the PRISM instrument is to display four quarter-screen tiles. These configurations show how to expand the applications to half- or full-screen tiles and reduce them back to a quarter of the screen.

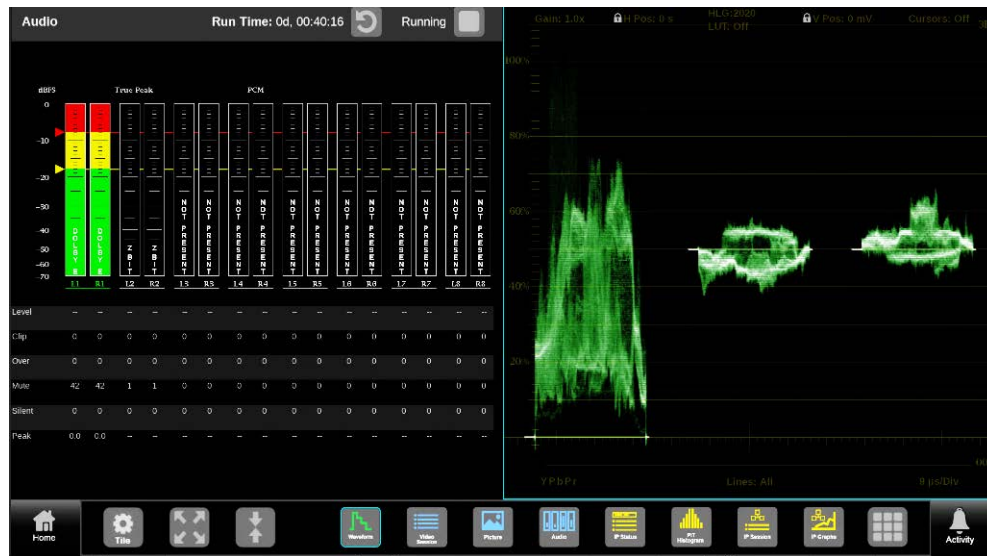

Half-Screen Tiles

There are several half-screen configurations. Select the **Tiles** icon (🗪) and then select the **Half-Screen** icon (🗪) to enlarge the tile vertically and the **Reduce** icon (🗪) to return to quarter screen.



Full-screen Tile

One tile has expanded to use the entire PRISM monitor. There are two ways to change to and from full-screen mode.

- double-tap an application to change it between full-screen and quarter- or half-screen mode; or
- select the **Tiles** icon () to open the application bar and select the **Reduce** icon () or the **Full-Screen** icon () to change between views.

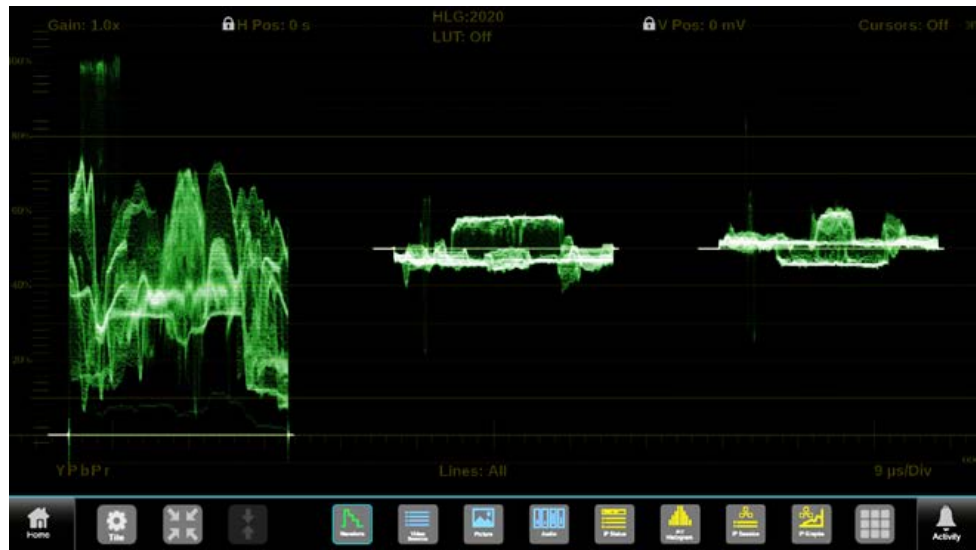

Quarter-Screen Tiles

You can size tiles to a quarter-screen to view up to four tiles at the same time. To change between quarter-screen mode and larger displays, do one of the following:

- Expand Tile to Entire Monitor (Full-screen Mode):
 - Double-click or double-tap an application to change between quarter-screen tile and full-screen mode.
 - Select the **Tiles** icon (🗄️) to open the application bar and select the **Reduce** icon (🗄️) or the **Full-Screen** icon (🗄️) to change between modes.
- Extend Tile Vertically (Half-screen Mode):
 - In the application bar, select the **Half-Screen** icon (🗄️) to expand the tile vertically.
 - Select the **Reduce** icon (🗄️) to change the tile to a quarter-screen.



On-Screen Tools

Some settings for the Waveform, Vector, Lightning, and Stop Display applications are available outside the Settings Menu through on-screen tools. Applications with on-screen tools enabled have buttons on the top and bottom of the display that allow you to adjust the application settings. When first selecting one of the displays, a highlighted ring appears around each available on-screen tool such as Gain, Format, Sweep, Cursors and Position. For instructions on how to use each on-screen tool, see these application sections:

- [Waveform Application On-screen Tools](#)
- [Vector Application On-screen Tools](#)
- [Stop Display Application On-screen Tools](#)
- [Lightning Application On-screen Tools](#)
- [CAM Application On-screen Tools](#)

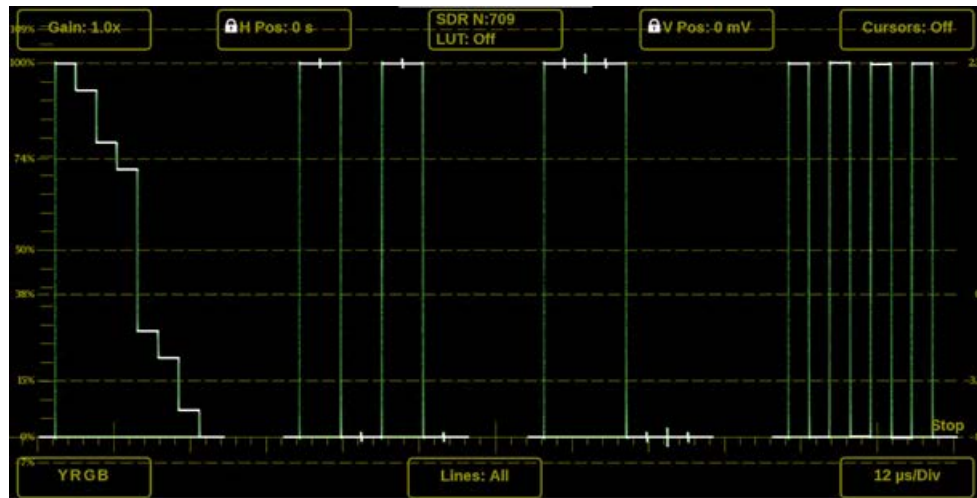

Keyboard and Mouse Operation

You can use a USB keyboard and mouse to operate the instrument. The mouse must have a scrolling wheel to access all of the menu selections. Select applications to perform actions like you would on the touch panel.

Connect the keyboard and mouse:

- Use the USB ports on the rear panel of the instrument (MPI2-25) or front panel (MPX2-25).
- Use the USB port on the front of the optional dual rack cabinet (MPI-RACK-MM or MPI-RACK-MW).
- Connect the external monitor to any of the available display outputs, including Display Port or HDMI (MPX2-25).

Home Icon: The Esc key on the keyboard is mapped to function as the Home icon, which closes any displayed menus.

Volume Control: If your keyboard has volume control keys, you can use them to control the volume of the audio output on the instrument.

Input and Preset Selection: Keyboard controls for selecting SDI inputs and instrument presets lists the keyboard controls to quickly select between the SDI inputs and to select from instrument presets 1 through 6.

Keyboard Controls for Selecting SDI Inputs and Instrument Presets

Action	Keyboard Control	Result
Input	ALT+i	Prepares the instrument for an input selection.
Preset	ALT+p	Prepares the instrument for a preset selection from preset Group A. Repeat 2-5 times to select preset Group B-F.
Select 1	1	Selects Input 1 or selects Preset 1 from the selected preset group.
Select 2	2	Selects Input 2 or selects Preset 2 from the selected preset group.
Select 3	3	Selects Input 3 or selects Preset 3 from the selected preset group.
Select 4	4	Selects Input 4 or selects Preset 4 from the selected preset group.
Select 5	5	Selects Input 5 or selects Preset 5 from the selected preset group.
Select 6	6	Selects Input 6 or selects Preset 6 from the selected preset group.

To select an SDI input or instrument preset:

1. On the keyboard, use one of two options:
 - Press **ALT** and **i** at the same time to make an input selection change.
 - Press **ALT** and at the same time press **p** one time to recall a preset from Preset Group A. Press the letter *p* 2-5 times to select a preset from another Preset Group (B-F). For example, press ALT and at the same time and press p three times to make a selection from Preset Group C.
2. Press a number from 1 to 6 to select the input or to select a preset from the selected Preset Group (A-F).

MPX2-25 Front-panel Controls

The following figure shows the key controls on the front panel of the MPX2-25. Descriptions of the elements are provided.



Descriptions of Numbered PRISM MPX2-25 Front-Panel Controls

Item number	Description
1	Power / Standby button: Press to turn the instrument on or off. To completely remove power from the instrument, remove the power cord.  CAUTION: To prevent data loss, we strongly recommend you shut down the instrument before disconnecting the power cord. Press Power / Standby or select Settings, Utilities, Power, and then Power Down Now.
2	BALANCE control: Turn to adjust the balance on the front and rear panel headphone and optional speaker outputs. Push the BALANCE control to recenter the balance.
3	PRESET button: Press once to prepare the instrument for a preset selection from preset Group A using the SELECTIONS buttons (1-6). Press the button repeatedly to select preset Group B-F.
4	SELECTIONS buttons (1-6): After pressing the PRESET or INPUT button, press one of the SELECTIONS buttons (1-6) to recall an instrument preset or to select an input to monitor.
5	VOLUME control: Turn to adjust the volume on the front and rear-panel headphone outputs. Push the VOLUME control to mute or unmute the audio.
6	Audio output: (1/4-inch—6.35mm—line out) port is for using headphones to listen to the selected audio channel pair.
7	USB ports: There are two USB 3.0 ports for connecting a mouse and keyboard, importing or exporting instrument presets, upgrading the instrument firmware, or saving screen and stream captures.
8	INPUT button: Press to prepare the instrument for an input selection using the SELECTIONS buttons (1-6).
9	Speakers: There are two integrated 2.1 speakers for listening to the selected audio channel pair. Requires Option SPKR.

MPX2-25 Front Panel Operation

Use the instrument front panel to perform these functions:

- Recall instrument presets
- Select an input to monitor
- Control or mute the volume on the headphone and optional speaker outputs
- Adjust the balance on the headphone and optional speaker outputs
- Connect a mouse and keyboard
- Connect a USB drive to upgrade the instrument or save screen and stream captures

Recall Instrument Presets

To recall instrument presets using the front panel:

1. Press the **PRESET** button to prepare the instrument for a preset selection from preset Group A using the SELECTIONS buttons (1-6).
2. Press the **PRESET** button repeatedly to select preset Group B-F. The selected preset group is displayed.
3. After you select the preset group, press the **SELECTIONS** numbered button corresponding to the preset in that group you want to recall (1-6).

Note: When you use the PRESET or INPUT buttons, the menus appear on the display. The menus close after a short delay. Similarly, when you use the VOLUME control, the volume and mute controls appear on the display and close after a short delay.

Select an Input to Monitor

To select an input to monitor using the front panel:

1. Press the **INPUT** button to prepare the instrument for an input selection.
2. Press the **SELECTIONS** numbered button corresponding to the input you want to monitor.

Display Operation

This section explains how to set up a second (extended) display for an MPI2. It also explains how to set up a single or dual display for an MPX2.

Note: For information about configuring a generic display as the extended display, refer to the API Help for the **display_list** and **requested_display_mappings**.

Configure MPI2 Extended Display

Extending the display requires two connections and software option MP2-EXTNDSP; without this option, the extended display will mirror the MPI2 display.

- Connect the Display Port output from the MPI2 monitor to the input on the external device.
- Connect the output of the external device to one of the MPI2 monitor USB ports.

Note: A monitor with a 1920×1080-capable display works best with the instrument.

Extended display mode requires a monitor that is Display Port capable to be connected to the DP2 port (bottom).

We recommend rebooting the instrument after connecting an external touchscreen.

To turn on the extended display mode:

1. Select the **Settings** icon () and then select **Display**.
2. Set the **Extended Display Mode** to **Enabled**.

Note: If the Extended Display Mode setting is turned off, the second display mirrors the primary display.

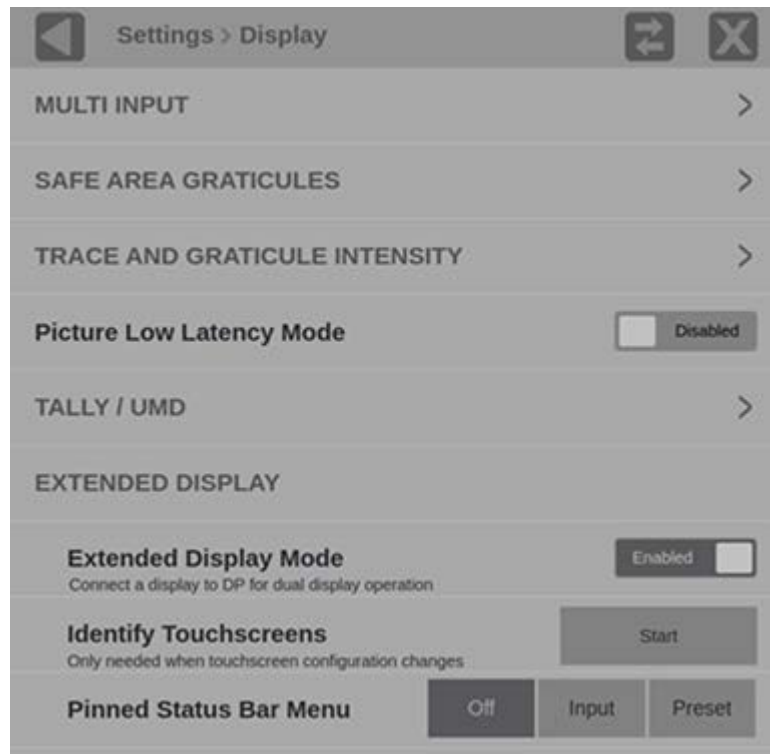

If the second display is touch-enabled, identify the locations of the displays.

1. Select **Start**.
2. Follow the on-screen instructions. When instructed to touch the primary and extended displays, use a touch gesture on the touchscreens; do not use a mouse. The touchscreens will not be properly identified if you use a mouse or if you configure remotely, such as with VNC.
3. If the displays appear to be non-responsive:
 - A. Connect a mouse to the instrument.
 - B. Select the **Home** icon () , select **Settings**, and then select **Display**.
 - C. Select **Start**. The displays are reset and respond to touch again.
4. Follow the on-screen instructions. Use touch to complete the steps; do not use the mouse.

Note: The process to identify the touchscreens can be performed again at any time. When the process completes successfully, it is not necessary to perform it again unless you change the touchscreen configuration, for example, if you change the USB port connections on the back of the instrument.

Note: When you turn on Extended Display Mode, the HDMI video port on the MPI2 is not available.

If needed, select a status bar for the extended display:

On the **Pinned Status Bar** Menu, select an option:

- **Off:** No status bar is in the extended display.
- **Input:** The Input status bar (the same status bar that appears when you select Input on the main display) appears in the extended display.
- **Preset:** The Preset status bar (the same status bar that appears when you select Preset on the main display) appears in the extended display.

Note: When you select Input or Preset to pin to the extended display, that option is unavailable on the status bar until it is unpinned from the extended display.

Configure MPX2 Displays

An MPX2 does not come with an internal display like other PRISMs. Monitors are needed depending on the number of application tiles in your workspace.

Note: Monitors with a 1920×1080-capable display works best with the instrument.

Note: We recommend rebooting the instrument after connecting an external touchscreen.

Display Mode

Display mode is the standard four usable tiles. A second monitor will duplicate the first monitor.

1. Make sure the MPX2 and monitor units are powered off.
2. Connect a Display Port-capable monitor or an HDMI-capable monitor to a Display Port or an HDMI port. Connect a second monitor if needed.
3. Power on all units.

Extended Display Mode

The extended display function requires software option MP2-EXTNDSP and a second monitor; it allows eight usable tiles. Without this option, the primary monitor is duplicated onto the second display.

Extended Display Mode requires either:

- two Display Port-capable monitors connected to the DP ports; or
- two HDMI-capable monitors connected to the DP ports with DP-to-HDMI adapters.

To set up Extended Display Mode:

1. Make sure the MPX2 and monitors are powered off.
2. Connect the MPX2 to the second monitor (or both monitors) and power on all units.

Note: The display mode will not function with one of each monitor type.

3. Select the **Settings** icon () and then select **Display**.
4. Set the **Extended Display Mode** to **Enabled**. If the Extended Display Mode setting is turned off, the second display mirrors the Primary display.

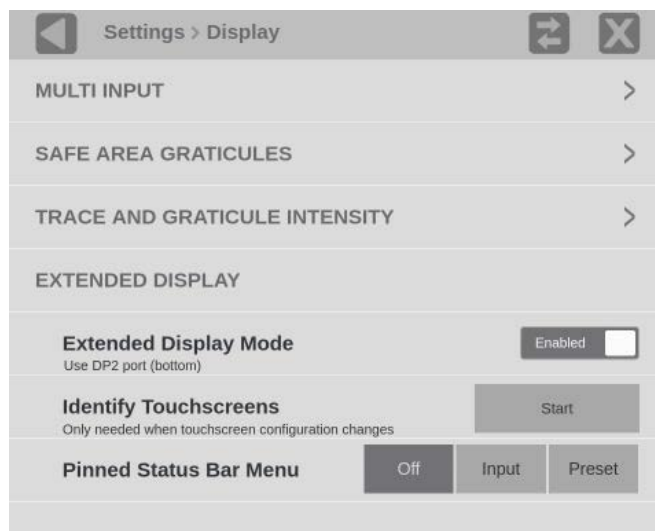

If the second display is touch-enabled, identify the locations of the displays.

1. Select **Start**.
2. Follow the on-screen instructions. When instructed to touch the Primary and Extended displays, use a touch gesture on the touchscreens; do not use a mouse.

Note: The touchscreens will not be properly identified if you use a mouse or if you configure remotely, such as with VNC.

If the displays appear to be non-responsive:

1. Connect a mouse to the instrument.
2. Select the **Home** icon () , select **Settings**, and then select **Display**.
3. Select **Start**. The displays are reset and respond to touch again.
4. Follow the on-screen instructions. Use touch to complete the steps; do not use the mouse.

Note: The process to identify the touchscreens can be performed again at any time. When the process completes successfully, it is not necessary to perform it again unless you change the touchscreen configuration, for example, if you change the USB port connections on the back of the MPX2 instrument.

Note: When you connect an MPX2-DUALDSP to an MPX2 the first time, the second display might be blank until an application is selected from the press-and-hold menu.

If needed, select a status bar for the extended display:

1. Set **Extended Display Mode** to **Enabled**.
2. In Pinned Status Bar Menu select an option:
 - **Off:** No status bar is in the extended display.
 - **Input:** The Input status bar (the same status bar that appears when you select Input on the main display) appears in the extended display.
 - **Preset:** The Preset status bar (the same status bar that appears when you select Preset on the main display) appears in the extended display.

Note: When you select Input or Preset to pin to the extended display, that option is unavailable on the status bar until it is unpinned from the extended display.

Remote Control Operation

You can control PRISM through WebRTC, VNC, API commands, or NMOS. The following section explains how to avoid connection loss, how to find the IP address, and how to find and change the hostname and password for PRISM.

Prevent Remote Connectivity Loss

Note: Before setting a PRISM instrument for remote use, do not set the PRISM Control IP Port address to the subnet of any of the Video IP Ports (or the Video IP Ports subnet to the Control IP Port address), or all remote connectivity (WebRTC, VNC, API) will be lost. If connectivity is lost this way, you need local access to the PRISM to correct it.

For more details about changing port addresses, see [Connect to a Network](#).

When the Control IP address is set in the subnet of a Video IP Port, any request comes in on the Control port but the response is returned through Video IP Port 1, so the response is not sent back to the sender, even though the PRISM Control port received the request. The sender is not connected to a network reachable by the Video IP Port 1.

This is an example of port settings that will cause a loss of connectivity:

- Control IP Port: 172.19.133.12 / 24 (255.255.255.0)
- Video IP Port 1: 172.19.227.177 / 16 (255.255.0.0)

The Control IP Port address 172.19.133.12 is within the Video IP Port 172.19.xxx.xxx address.

Perform the following steps to change the subnet mask / prefix number without losing remote connectivity:

1. Disable the port:
 - A. Select the **Settings** icon () and then select **Network**.
 - B. Select the **VIDEO IP PORT** tab.
 - C. Change the **Data Rate** to the unselected option (if you are using a 10Gb rate, select 25Gb; if you are using 25Gb, select 10Gb).
2. In the **Subnet Mask / Preset** box, select the up or down arrows to set the number to **/30**.

Note: The /30 is close to a link local address. It is unlikely to accidentally forward traffic to that interface; the Video IP Ports can remain active without interfering with Control Port traffic.

3. On the **VIDEO IP PORT** tab, reset the **Data Rate** back to the original rate.
4. If you made this change locally, test the remote connectivity is still available by logging on to the PRISM web page.

Find or Change Hostname, Password, and IP Address

This section explains how to find the hostname, password, and IP address of a PRISM, as well as how and where to change the hostname and password.

Find Hostname

On the status bar, the current hostname is under the Telestream logo.



Change Hostname

1. On the PRISM monitor to connect to, select the **Settings** icon (⚙️).
2. Select **Network** and then select the **REMOTE ACCESS** tab.

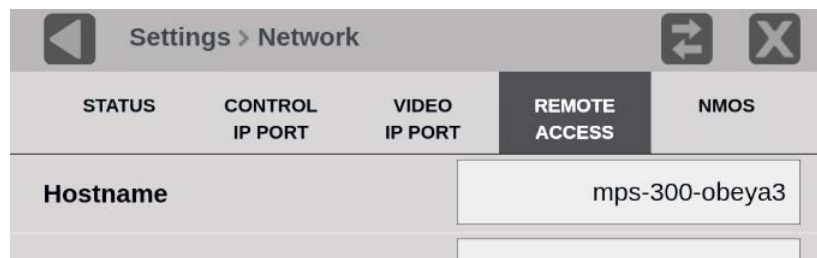

3. In the **Hostname** box, type a new hostname with the remote keyboard or the on-screen keyboard.
4. Select **Save**.

Find and Change Password

1. On the PRISM monitor to connect to, select the **Settings** icon (⚙️).
2. Select **Network** and then select the **REMOTE ACCESS** tab.

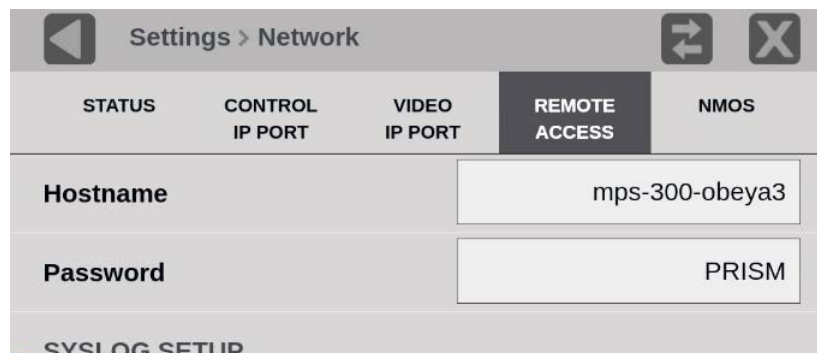

3. In the **Password** box, type a new password.
4. Select **Save**.

Find IP Address

Note: The IP address can change, but it is an automated action. It cannot be changed by the user.

1. On the PRISM monitor to connect to, select the **Settings** icon ().
2. Select **Network** and then select the **STATUS** tab. The IP address of the instrument is in the Control IP Port section.

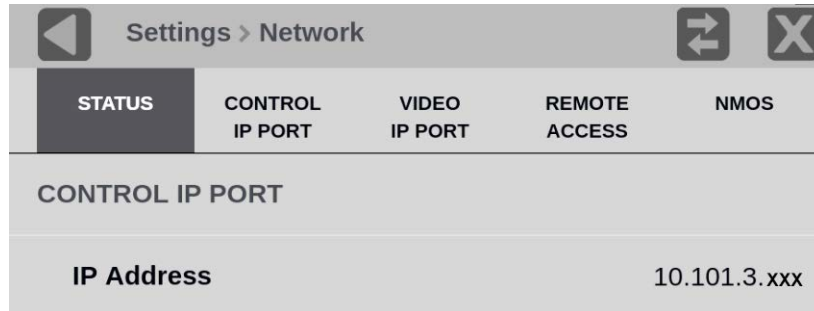

Remote Control through WebRTC

When the PRISM monitor is connected to an Ethernet network, you can use a computer connected to the same network to remotely control the instrument and listen to the audio through a web browser. Setting a remote connection has a point where it is possible to lose a connection that can only be corrected by direct, in-person access to the PRISM. To understand and prevent this problem, see [Prevent Remote Connectivity Loss](#).

Note: The WebRTC capability is not supported if you are using an MPI or MPX that is upgraded with a -25 multimedia board. An MPI2-10 or MPX2-10 upgraded with a -25 multimedia board does support WebRTC.

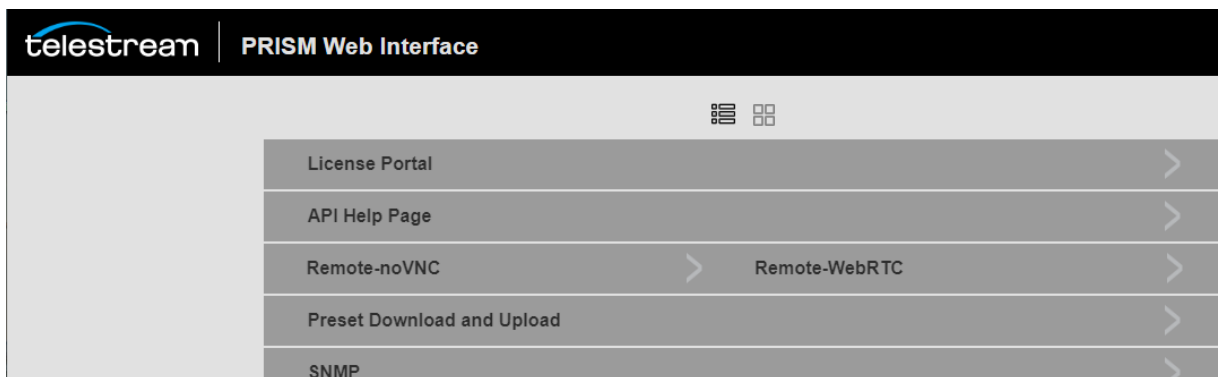

Connect with WebRTC

1. In a web browser, enter the hostname or IP address of the PRISM. See [Find or Change Hostname, Password, and IP Address](#). When the PRISM is connected, the PRISM HOME page is displayed.
2. Select **Remote-WebRTC**. A sign-in page appears.
3. In the **Password** box, type the password for that instrument.
4. If it is needed, in the **User Name** box, type the user name for the WebRTC chat tool.
5. Select **WebRTC Connect**.

Adjust WebRTC Settings

Select the WebRTC menu button at the top left of the tiles. The WebRTC menu appears at the top of the tiles.

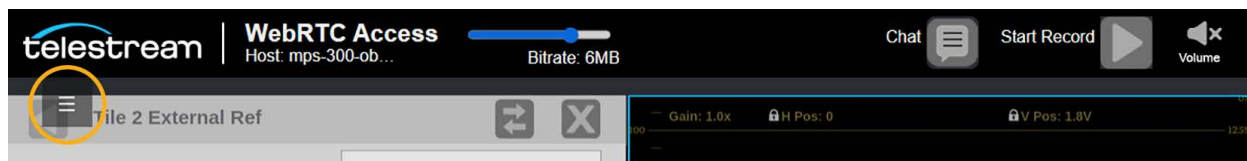

WebRTC Access

Displays the hostname of the instrument.

Bitrate

The slider control changes the bandwidth and fidelity of the images. If the data available (for example on a slow network) does not allow a smooth view of the PRISM information, adjust the Bitrate control. Start with Bitrate at 2 MB or less. Any change to the Bitrate control changes the bitrate of all the users on the instrument.

Chat

Select to open a chat message window with other people using the PRISM through WebRTC. If you entered a user name when you logged in, it is shown in the chat window. If you did not enter a user name, a hexadecimal ID is shown.

Start Recording

Select to start and stop a recording of the screen and audio as it is presented on the PRISM. When recording is stopped, a .webm file is downloaded to the local computer in the downloads folder.

Volume

Select to turn the audio on and off. The WebRTC volume level is controlled with the computer volume controls.

Remote Control through VNC Operation

When the PRISM monitor is connected to an Ethernet network, you can use a computer connected to the same network to remotely control the instrument in a web browser or in VNC client such as VNC Viewer. Setting a remote connection has a point where it is possible to lose a connection that can only be corrected by direct, in-person access to the PRISM. To understand and prevent this problem, see [Prevent Remote Connectivity Loss](#).

To access eight tiles remotely in an MPI2, it must be connected to a second display or a display emulator. To access eight tiles remotely in an MPX2, it must either be connected to *no* displays or two displays.

Connect with VNC Client

When using VNC for extended periods of time, we recommend using a VNC client:

1. On an Internet-connected computer, open a VNC client.
2. Enter the hostname or IP address from the instrument in the VNC Server search bar. See [Find or Change Hostname, Password, and IP Address](#). The VNC client connects to the instrument in a separate window that appears exactly like the instrument display.

Connect with Web Browser

1. Enter the hostname or IP address from the instrument in a web browser. See [Find or Change Hostname, Password, and IP Address](#). The PRISM HOME page appears.
2. Select **Remote noVNC Access**. A noVNC page appears.
3. Select **Connect**. A sign-in page appears.
4. Enter the password for that instrument in the **Password** box and select **Send Credentials**.

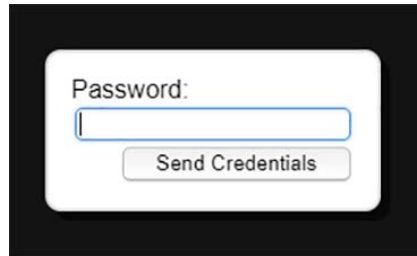

To adjust the scale of the PRISM tiles (if the tiles do not all fit on the display):

1. In the PRISM web interface, select the control tab on the left side of the tiles to open the noVNC Settings.



2. Select the **Settings** icon.
3. In the **Scaling Mode** menu, select **Local Scaling**. The tiles resize to fit the web browser window.

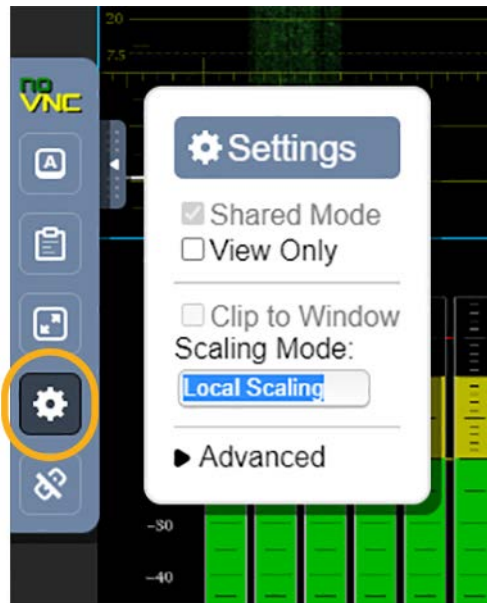

4. Select the **Settings** icon again to close the Settings menu.

Remote Control through API Commands

The PRISM monitor has a command set for controlling the instrument using REST-style API commands. You can use GET and POST commands to configure the signal inputs and to select the active input. Setting a remote connection has a point where it is possible to lose a connection that can only be corrected by direct, in-person access to the PRISM. To understand and prevent this problem, see [Prevent Remote Connectivity Loss](#).

1. Enter the hostname or IP address in a web browser. See [Find or Change Hostname, Password, and IP Address](#). The PRISM HOME page appears.
2. Select **API Help Page**. A PRISM API Documentation web page similar to the sample appears.

telestream | **API DOCUMENTATION**

i **Choosing a Scope:**
To send a scope with an API request add a slash followed by the desired scope to the URL.

Example:
localhost:9000/api/API_NAME/SCOPE

i **Selecting a field in a returned object:**
If a GET request returns an object, a specific member can be selected by adding a field query to the URL. To access a member enter the path to it, starting with "object" and separated by ".".

Example: localhost:9000/api/API_NAME?field=object.parent1.parent2.target

Groups: All Search by: Name Description

NAME	MODE	DATATYPE	DESCRIPTION
anc_session_control	GET / POST	ints	Reset anc session. Option: ANC_ENGINE_SESSION_CONTROL_RESET.
audio_ballistic	GET / POST	ints	Ballistic Type for Audio Bars. Available Options: AUDIO_BALLISTIC_PPM_1, AUDIO_BALLISTIC_PPM_2, AUDIO_BALLISTIC_TRUE_PEAK
audio_program_level	GET / POST	floats	Set/Read audio program level. Valid range: Values from -31.0 through 0.0
audio_test_level	GET / POST	floats	Set/Read audio test level. Valid range: Values from -31.0 through 0.0
loudness_loud_level	GET / POST	floats	Loudness loud level, valid range is in between 0 to -31
loudness_quiet_level	GET / POST	floats	Loudness quiet level, valid range is in between 0 to -60
loudness_target_level	GET / POST	object	Loudness target levels as part of JSON Object. An example of Loudness target levels { "target" : Target threshold in LKFS (Loudness units). Valid Range is in between 0 to -31dB "target_low" : Relative Offset below the target level. (In Loudness Unit(LU)). Ranges from 0.0 to 10.0

Remote Control through NMOS

See [Using NMOS](#) for details about NMOS remote control of the instrument.

Camera Tally and UMD

Camera Tally and Under Monitor Display (UMD) allows use of the TLS version 5.0 protocol over Ethernet using UDP transport to send information to the IP address of PRISM using port 5446. This protocol provides red, amber, or green indication per tile of the state of the channel and can be used to provide an ASCII character label that will appear in the tile. A fourth Tally function provides a red dot in the upper right corner of the tile.

1. Select the **Settings** icon () and then select **Display**.
2. Select **Tally UMD**.

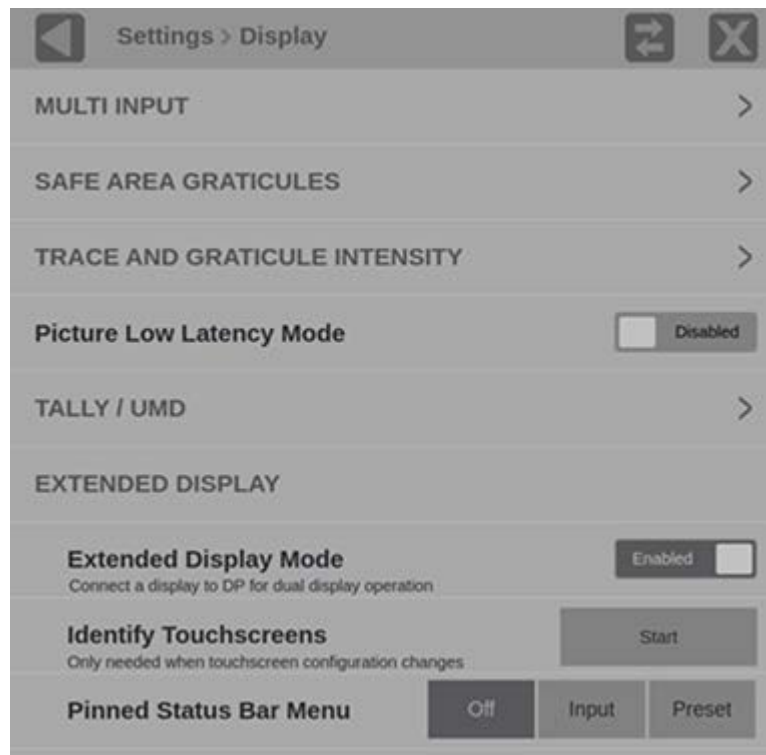

3. Set **TALLY** to **Enabled** to enable the received TSL protocol to provide information for each of the tile displays and allow the indication of red, amber, or green to be shown for the appropriate tile.
To disable this Tally display, set **TALLY** to **Disabled**. Note: Disabling Tally resets the tally configurations.
4. Set **UMD** to **Enabled** to allow an on-screen label to be overlaid on a tile when the appropriate protocol message is sent.
To disable this UMD label on-screen, set **UMD** to **Disabled**.
5. From the **Position** list, select the position of the UMD label: **Top** or **Bottom** of the tile.
6. From the **Background Color** list, select the background color of the UMD label: **Black**, **Red**, **Green**, or **Blue**.
7. From the **Background Transparency** list, select the background transparency level for the UMD label: **Solid**, **25%** transparency, **50%** transparency, **75%** transparency, or **Clear**.
8. From the **Picture / Trace Size** list, select one of the following:
 - **Normal** – The UMD label is overlaid on top of the tile.
 - **Shrunk** – The Picture or Trace is scaled so the UMD label does not obscure any part of the tile display.
 - **Auto** – The tile content is shrunk only if the UMD label is enabled and present.

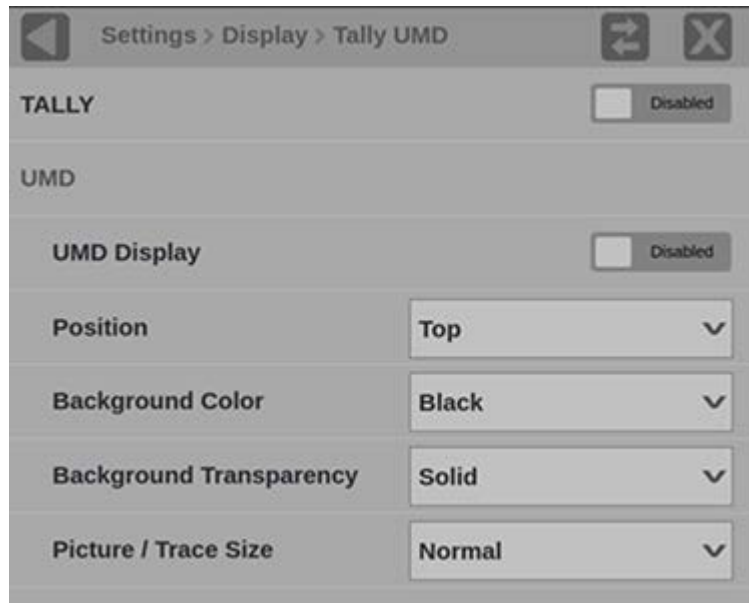

The following image shows Tally and UMD information being sent to multiple tiles. This configuration has UMD positioned at the top of the tile with a solid black background and a normal overlay of the label within the tile.

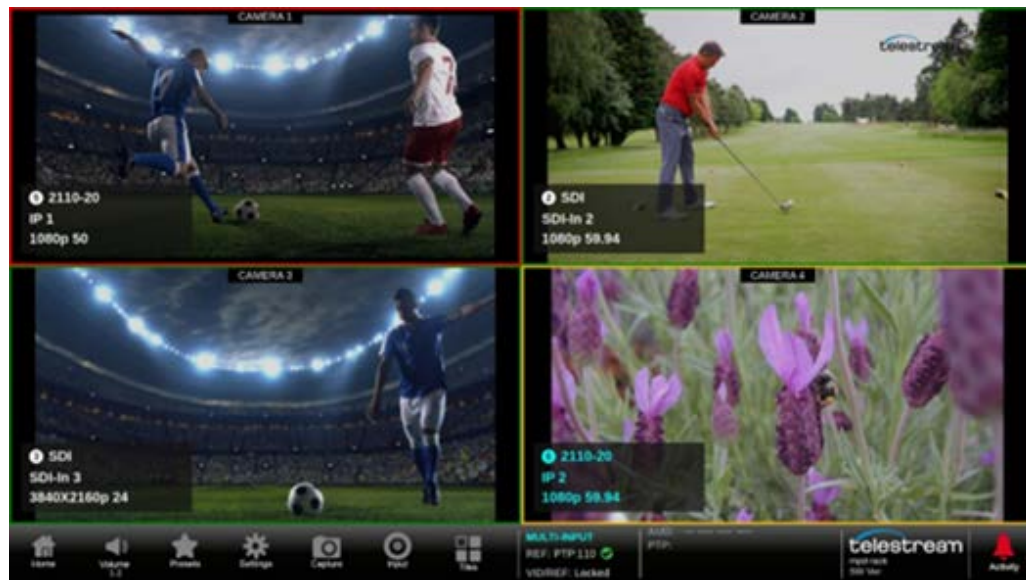

To display Tally/UMD information on a tile, version 5.0 UMD messages must be sent with the following fields:

Note: The TSL UMD/Tally protocol specifies little-endian (LSB/MSB) byte order. All examples provided are in little-endian format.

- **INDEX Field:** The INDEX field (16 bits) in the (DMSG) section controls tile selection, subtitle selection, and fourth tally. The template is as follows:

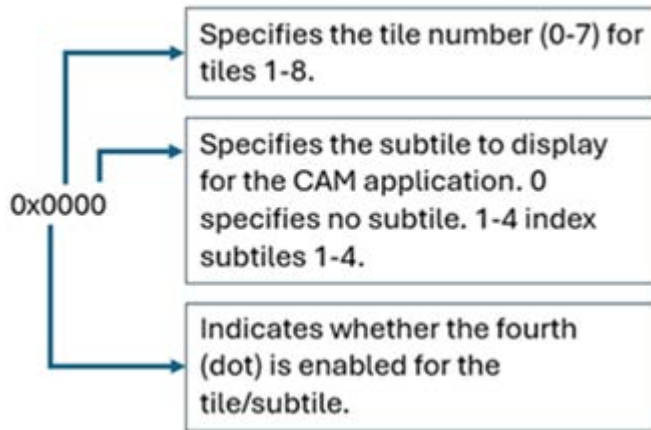

- **CONTROL** (16 bits) within the (DMSG) section manages the main tally lights for each tile:
 - **Bits 0-1:** Control the red tally light. These bits are also used to control the fourth tally light when it is enabled (as indicated by the INDEX field).
 - **Bits 2-3:** Control the amber tally light.
 - **Bits 4-5:** Control the green tally light.
- **(Display Data):** This section controls the UMD text displayed on each tile.
 - **LENGTH:** (16 bits) Indicates the byte count of the text field (maximum 20 characters). Set to 0 to turn off UMD for that tile.
 - **TEXT:** Contains the actual UMD text to be displayed. Note that 0x00 should be interpreted as a space character (0x20).

Important note: The TSL UMD/Tally protocol uses little-endian byte order. This means that the least significant byte (LSB) of the INDEX value is transmitted first, followed by the most significant byte (MSB).

For additional information, see Tally Protocol 5.0:

<https://tslproducts.com/media/1959/tsl-umd-protocol.pdf>

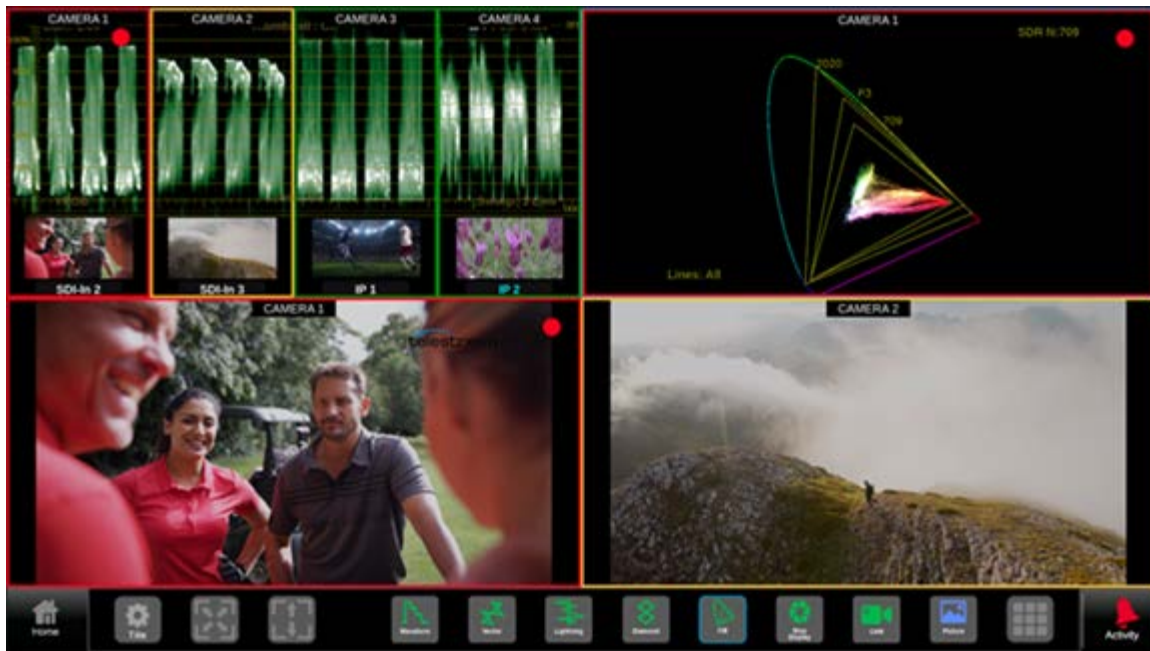
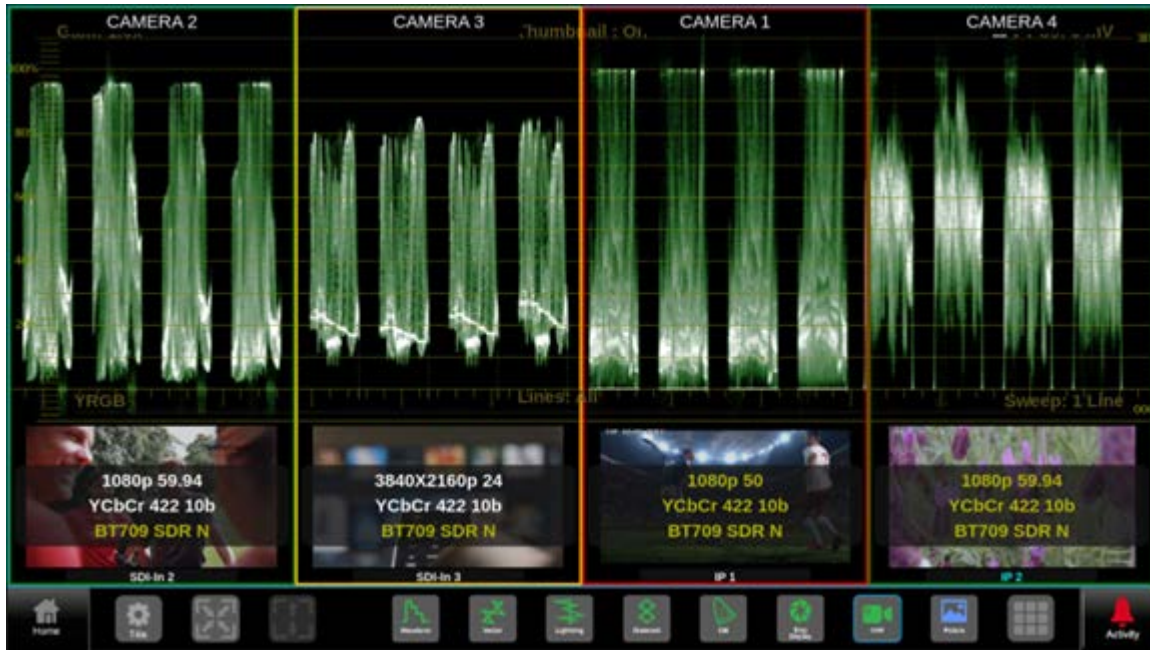

Configure the Instrument

This chapter describes how to configure these instrument settings:

- Virtual inputs: [Configure and Select Virtual Inputs](#)
- HDR monitoring: [Configure Instrument for HDR/WCG Monitoring](#)
- PTP reference settings: [Configure Reference Settings](#)
- Presets: [Configure and Recall Instrument Presets](#)
- Internal time and date: [Configure Time and Date](#)
- Firmware upgrade: [Upgrade Instrument Firmware](#)
- Installed software and hardware versions: [Verify Firmware Upgrade](#)

Most of the instrument settings are controlled using the Settings menu. To access the Global Settings menu, select the **Settings** icon () in the status bar.

Note: Some settings require you to enter values. You can use a USB keyboard to enter these values instead of using the touchscreen keypad on the instrument.

Configure and Select Virtual Inputs

To configure multiple virtual inputs, select **Settings** and then select **Inputs** for options:

- [Configure SDI Inputs](#)
- [Configure IP Inputs](#) (this includes ST 2022-6 and 2110-20/22/30/31/40 and RTP streams)
- [Select Input](#)
- [Rename Virtual Input](#)

The input selection of PRISM is displayed in the middle of the status bar. The first line is the user-defined name, and the second line is the format.



CAUTION: IGMP communications fail if the Video IP Ports are configured for the same IP address.

Configure SDI Inputs

Note: SDI quad link for 4K or 8K is available only when software option MP2-FMT-4K or MP2-FMT-8K is present. If this option is not present, only a single-link input can be configured. SDI quad link for HD, SD, and 3G is always available.

Configure SDI Input

1. Select the **Settings** icon ().
2. Select **Inputs**.
3. Select an input and then select **SDI**.



Note: You can give the virtual inputs any name.

4. Select one of the two options:
 - select **Single** for the Input Configuration and select one of the four physical SDI inputs to monitor; or



- select **Quad Link** for the Input Configuration and confirm that Quad Link cables are connected to the back of the instrument:
 - ◆ Quad Link A is connected to SDI-IN 1.
 - ◆ Quad Link B is connected to SDI-IN 2.
 - ◆ Quad Link C is connected to SDI-IN 3.
 - ◆ Quad Link D is connected to SDI-IN 4.

Note: To use Quad Link Inputs, you must connect all four SDI inputs to a cable on the back of the PRISM.

5. In the **UHD/4K Mode** section, select **Auto**, **Sq Div** (Square Division), or **2 SI** (Two Sample Interleave). SDI 1-4 (Link A-D) is selected by default.



Note: The Quad Link and UHD/4K Mode buttons are available only when software option MP2-FMT-4K is present.

In AUTO mode, the instrument defaults to Two Sample Interleave mode if the Video Payload Identifier (VPID) complies with ST 425.3 or ST 425.5. The instrument defaults to Square Division mode if the VPID complies with ST 292.1, ST 372, ST 425.1, or a quad-HD signal is present and VPID is missing. VPID in the signal is required for this option to operate properly.

The 8K format trace applications—Waveform, Stop, Vector, Diamond, and Lightning Displays, enabled by MP2-FMT-8K—are rendered based on the resized 8K signal and are suitable for operational applications such as setting camera exposure for live programming. However, this approach might not be suitable for some engineering applications. This approach impacts only 8K formats and not SD/HD/3G/4K formats in either operations or engineering. 8K formats can use up to four trace applications.

Select SDI Video Settings

These settings are the same for Single and Quad Link input configurations. The Gamma and Color Gamut settings define the characteristics of the video signal.

Note: Auto is the preferred setting for video options. At this setting, PRISM determines the settings from the signal or any metadata (if present).

1. Under **SDI**, select **Video**.



2. Choose the **Format** option from the menu:

- **Auto:** The system selects the correct setting based on the information in the incoming signal.
- **525i**
- **625i**
- **720p**
- **1080i**
- **1080PsF**
- **1080p**
- **2048x1080p**
- **3840x2160p**
- **4096x2160p**
- **7680x4320p**

3. If a 3-gigabit transport is being used, select the **In 3G-SDI** menu and choose:

- **Auto:** The system selects the correct setting based on the information in the incoming signal.
- **Level A**
- **Level B**

4. Select the **Gamma Curve** menu and select the option. The selection characterizes the video signal on each virtual input.

- **Auto:** The system selects the setting based on ST 352 VPID. If 352 VPID is not present, SDR Narrow is selected.
- **SDR Narrow:** The reference OETF (Optical to Electrical Transfer Function) is defined in ITU-R BT.709 with gamma of 0.45 and the reference EOTF is defined in ITU-R BT.1886 with gamma of 2.4.

The Narrow scaling places the extremes of the nonlinear color value from zero to unity at code words 40 hex (64 dec) and 3AC hex (940 dec) in a 10bit representation for 0% to 100% graticule scale. This range is typical for standard-dynamic range.

- **SDR Full:** The reference OETF is defined in ITU-R BT.709 with gamma of 0.45 and the reference EOTF (Electrical to Optical Transfer Function) is defined in ITU-R BT.1886 with gamma of 2.4.

The full scaling places the extremes of the nonlinear color value from zero to unity at code words 0d and 1023d in 10bit representation and 0d and 4095d in 12-bit representation for 0% black and 100% white, respectively.

- **PQ Narrow:** The reference OETF with a high luminance range capability of 0 to 10,000 cd/m² standardized in ST 2084. The EOTF is the inverse of OETF.

The narrow scaling places the extremes of the nonlinear color value from zero to unity at code words 40 hex (64 dec) and 3AC hex (940 dec) in a 10bit representation for 0% to 100% graticule scale. This range is typical for standard-dynamic range.

- **PQ Full:** The reference OETF with a high luminance range capability of 0 to 10,000 cd/m² standardized in ST 2084. The EOTF is the inverse of OETF.
 The full scaling places the extremes of the nonlinear color value from zero to unity at code words 0d and 1023d in 10-bit representation and 0d and 4095d in 12-bit representation for 0% black and 100% white, respectively.
- **HLG:** The reference OETF is standardized in ARIB B67 and the reference EOTF is standardized in ITU BT.2100 at the nominal display peak luminance of 1000 nits.
- **S-Log2:** The reference OETF is defined as Sony S-Log2.
- **S-Log3:** The reference OETF is defined as Sony S-Log3.
- **S-Log3 (Live HDR):** The reference OETF and OOTF (Optical to Optical Transfer Function) is defined as Sony S-Log3 (Live HDR).
- **Log C:** The reference OETF is defined as ARRI Log C.

5. Choose the **Structure option from the menu:**

- **Auto:** The system selects the correct setting based on ST 352 VPID. If 352 VPID is not present, YCbCr 4:2:2 10bit is selected.
- YCbCr 4:2:2 10bit
- YCbCr 4:2:2 12bit
- YCbCr 4:4:4 10bit
- RGB 4:4:4 10bit
- RGB 4:4:4 12bit

6. Choose the **Color Gamut option from the menu. This selects the color space of the video signal selection.**

- **Auto:** The system selects the setting based on ST 352 VPID. If ST 352 VPID is not present, Rec. 709 is selected.
- **Rec. 709:** Standard for HD
- **Rec. 2020:** Standard for 4K

Note: Rec. 709 gamut is selected automatically when the SD format is detected / selected in the video signal.

Select SDI Audio Settings

The Audio settings define how the audio is embedded in the SDI input signal. These settings are the same for Single and Quad Link input configurations, except the Quad Link, which is intended for 8K, can have 32 channels—instead of 16—in Program Configuration.

To configure the SDI audio settings:

1. Under **SDI**, select **AUDIO**.



2. To enable 32-channel mode (UHD, 4K, and 8K only), set **32 Channel Mode** to **On**.
3. Configure one type of audio. See [Configure PCM](#), [Configure DOLBY](#), or [Configure DOLBY ED2](#) (use of Dolby or Dolby ED2 requires the MP2-DLBY license).

Configure PCM

- A. Under **AUDIO**, select **PCM**.
- B. Select **Program Configuration**.
- C. Set the **Program Configuration** control to **On**.
- D. Select **Edit**. The Edit button disappears and the Default, Clear, and Undo buttons replace it.

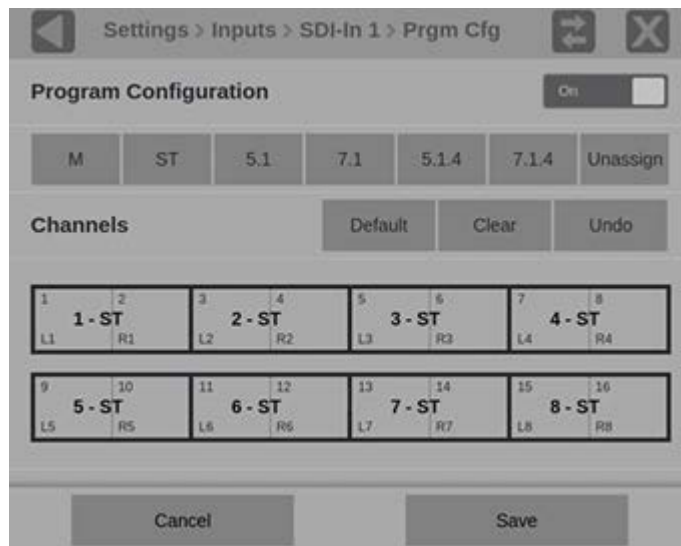

Note: 8k (Quad 12G-SDI Link) and 4K (Single 12G-SDI Link) can have 32 channels instead of 16.

E. Select the type of program (mono, stereo, etc.) and select the audio channel to assign it. Repeat until all the audio in the current input signal have programs assigned to channels.

- ◆ **M** is mono, one channel.
- ◆ **ST** is stereo, two channels.
- ◆ **5.1** is surround sound, six channels.

To change the channel order in the audio bars, see [5.1 Channel Order](#).

- ◆ **7.1** is surround sound, eight channels.
- ◆ **5.1.4** is immersive audio and requires 10 channels: six for the audio main bed, or level–marked in cyan, and four for the audio upper bed, marked in orange.

Note: 5.1.4 provides bar labels for the audio channels, but is not available for downmix capability or for loudness display.

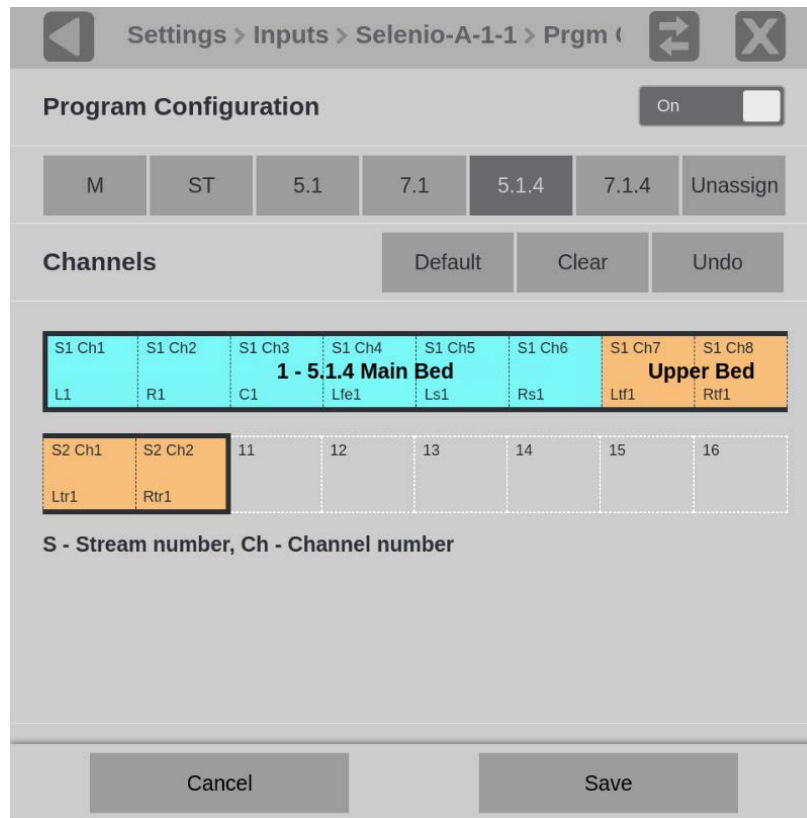

- ◆ **7.1.4** is immersive audio and requires 12 channels: eight for the audio main bed, or level–marked in cyan, and four for the audio upper bed, marked in orange.

Note: 7.1.4 provides bar labels for the audio channels but is not available for downmix capability or for loudness display.

- ◆ **Unassigned** removes an assignment from a channel. Select **Unassigned** and select any block in an assignment, for example select the middle of a 7.1 assignment, the entire assignment is removed and is not displayed on the Audio application.
- ◆ **Default** resets the channels to eight stereo pairs.
- ◆ **Clear** removes all assignments, including the default.

F. Select **Save** and close the menu.

Note: You must save the program configuration to update the programs in the audio bars and loudness meter.

Configure DOLBY

Note: Dolby selection works with Dolby D, D Plus, or E signals.

A. Under **AUDIO**, select **DOLBY**.



B. In the **Dolby Audio Ch Pair** menu, select the audio channel pair that contains Dolby audio.

C. If needed, identify Dolby Audio Channels, or go to Step D:

- a. Open the Audio application.

- b. Return to the **Input** menu and select the **PCM** option in Audio.
- c. In the Audio application, in the audio levels, find and note the audio channels marked with either DOLBY D or DOLBY E.



- d. In the **Input** menu, select the **DOLBY** option again.
 - e. In the **Dolby Audio Ch Pair** menu, select the channel pair that is marked as DOLBY in the Audio application. The audio bar layout is automatically configured based on the metadata in the Dolby stream.
- D. Select **Save** and close the menu.

Configure DOLBY ED2

- A. Under **AUDIO**, select **DOLBY ED2**.



- B.** In the **Dolby ED2 Audio Ch Pairs** menu, select the audio channel pairs that contain Dolby ED2 audio.
- C.** If needed, identify Dolby ED2 audio channels, or go to Step D:
 - a.** In the **Input** menu, select **PCM** (instead of DOLBY ED2).
 - b.** Open the Audio application.
 - c.** In the Audio application, in the audio levels, find and note the audio channels marked with "DOLBY ED2."

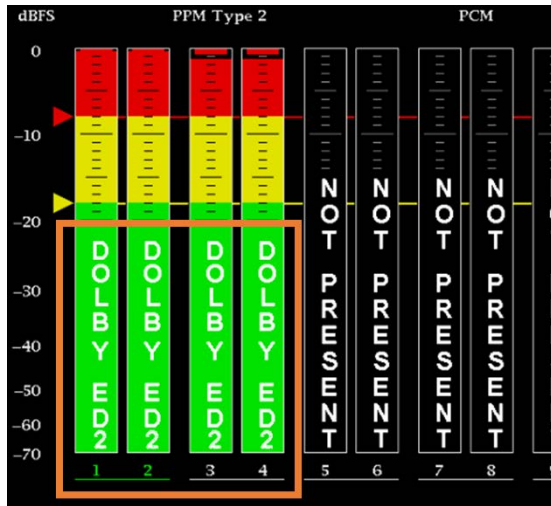

- d.** In the **Input** menu, select the **DOLBY ED2** option (instead of PCM).
- e.** In the **Dolby ED2 Audio Ch Pairs** menu, select the channel pairs that are marked as DOLBY ED2 in the Audio application. Dolby ED2 metadata in the selected channels is decoded.

Note: When you select Dolby ED2 in the Input menu, the Audio application will stop presenting data. This is expected; only Dolby ED2 metadata is supported.

- D.** Select **Save** and close the menu.

Note: Audio programs configured in the Program Configuration menu are used to select a program for measurement by the Loudness application, to display audio bars in the Audio application, and to monitor with headphones. When all the channels are unassigned, all the channels are treated as stereo pairs. The audio programs in the Dolby stream are automatically set up based on the Dolby metadata.

Rename Virtual Input

1. Select the **Settings** icon ().
2. Select **Inputs**.
3. Select an input and then select the **Name** field. The text editing display opens.



4. Use the editing controls to enter a new name for the input. Some notes on using the text editor:
 - Enter a name with a maximum of 16 characters.
 - Select the **Clear** icon (X) next to the input box to remove the existing name.
 - Tap **Shift** to access capital letters.
 - Tap **Backspace** to delete characters by backspacing over them.
 - Tap the **123-abc** key to change between accessing letters and numbers/symbols.
5. Select **Enter** and then select **Save**.

Configure IP Inputs

Configure Data Rate

1. Select the **Settings** icon (⚙️).
2. Select **Network**.
3. Select the **VIDEO IP PORT** tab.
4. Select the **Data Rate** option (10Gb or 25Gb). The Data Rate applies to both ports; both ports must be 10Gb or 25Gb.

Note: If you cannot select the 25Gb button, the MP2-25GE license has not been installed.

5. If you are using a 25GE connection with RS-FEC, set FEC to **RS-FEC**.

Note: If the 25-GE signal from the switch does not match the PRISM in FEC setting, the IP Status Port displays a red X and 0.0 bps. This response is similar to a disconnected fiber cable.

PRISM does not support RS-FEC auto-negotiation, you may have to manually configure your switch to enable or disable RS-FEC.

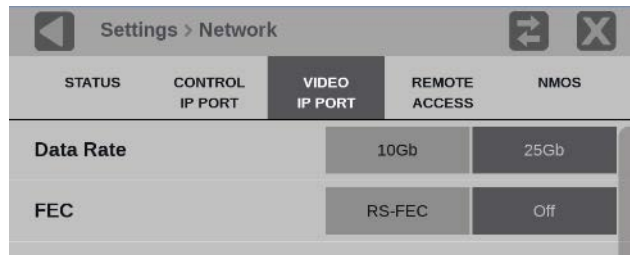

- If the instrument can read the multisource agreement (MSA) data from the installed SFP module, the data rate of the SFP module and the optical wavelength is displayed in the SFP Module section.

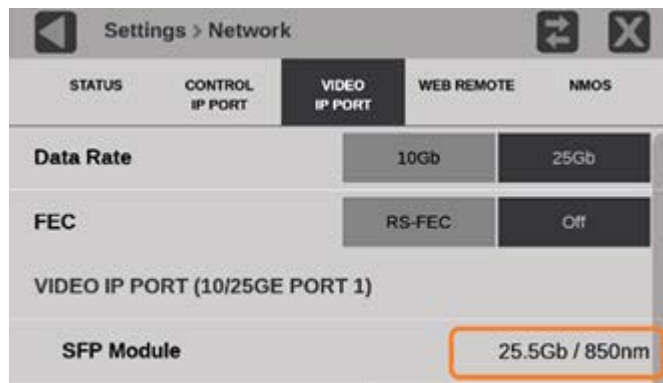

- If the SFP module speed does not match the Data Rate setting, instead of the data rate and frequency, the message "SFP not compatible with selected Data Rate" appears.
If the SFP module does not have readable MSA data, instead of the data rate and frequency, the message "Unknown" appears.

Note: If MSA data is missing, the SFP Module line displays no compatibility warning regardless of what type of SFP module is installed or Data Rate setting. The instrument and the SFP module work if the SFP module matches the Data Rate setting.

- If no SFP module is installed, instead of data rate and frequency, the message "Disconnected" is displayed.

Possible Status in the VIDEO IP PORT, SFP Module Line

Type of SFP installed	Data Rate Setting	
	10 Gb Setting	25 Gb Setting
SFP 25-Gb module	SFP not compatible...	(Data rate) / (frequency)
SFP 10-Gb module	(Data rate) / (frequency)	SFP not compatible...
Unreadable MSA data	Unknown	Unknown
No SFP installed	Disconnected	Disconnected

6. Select **RS-FEC** if Forward Error Correction (FEC) is needed. RS-FEC is specified by IEEE 802.3 Clause 91.

Note: FEC is available only when the Data Rate is set to 25Gb. FEC can only be selected for both ports. If it is on for one, it is on for both.

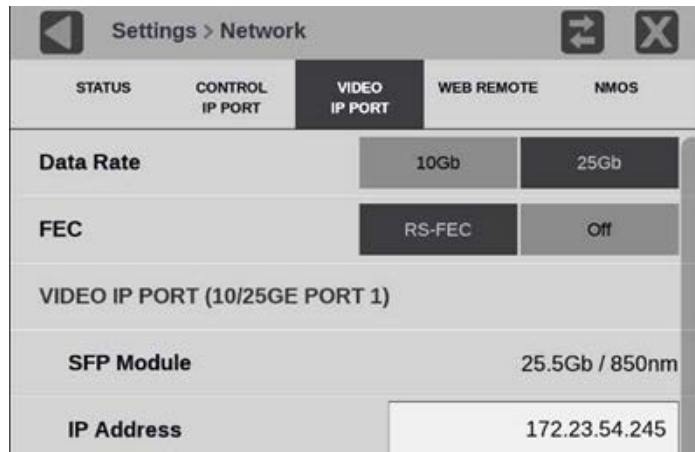

○ The IP Status display shows the Data Rate setting, FEC setting, and signal status.

Note: If the Data Rate or FEC are incorrect, a red X appears on the left of the traffic bar, as when the fiber is disconnected.

- The Data Rate setting (10 or 25 Gb) is on the right of the network traffic bar.
- The FEC setting is below the data rate.
- The signal status is on the left of the network traffic bar.

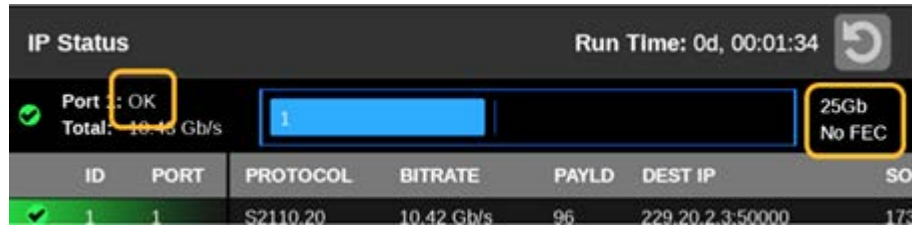

Possible Status of the Ports in IP Status

Type of SFP Installed	Data Rate Setting	
	10Gb	25Gb
SFP 25-Gb module	SFP Mismatch	OK
SFP 10-Gb module	OK	SFP Mismatch
Unreadable MSA data	Unknown	Unknown
No SFP installed	Disconnected	Disconnected

7. If the IP Status Port displays “SFP Mismatch,” repeat Steps 1 through 4 to confirm the Data Rate is set correctly and check whether the installed SFP module has the expected data rate.

Configure ST 2022-6

Note: If you are not using 2022-6, go to [Configure ST 2110](#).

1. Select the **Settings** icon (⚙️).
2. Select **Inputs**.
3. Select the input from the list.
4. Select **IP**.



5. Under **IP**, select **ST2022-6**.

6. Set the **ST2022-7 Seamless Switching** control to **Enabled** or **Disabled**.

Note: There is a difference between “port” and “path.” The port is the physical SFP port that is used to input the 10/25GE signal. Path 1 and Path 2 are the signal paths to be used for seamless switching. This distinction is important because Path 1 can also be configured to use Port 2.

Note: With ST2022-7 seamless switching, a reconstructed output stream is created from the two input streams. The reconstructed stream is used downstream for various display tiles like Picture. The buffer size to absorb the packet reception time difference between Path1 and Path2 is 10 ms. The output stream reconstruction does not work properly for streams on Path1 and Path2 with skew greater than 10 ms. This error makes tiles show the wrong images and information.

7. Enter the **Source** and **Destination** information for Path 1 and Path 2, if applicable.

Note: Path 2 is available only if ST2022-7 Seamless Switching is enabled. You may have to scroll down to see Path 2.

8. To have the instrument ignore a parameter, select the **Unmasked** control next to the parameter to change the state to **Masked**.

9. To edit one of the parameter values, select inside the parameter box to open the editing display. An on-screen keypad appears.



10. When you are done editing, select **Enter**.
11. Scroll down to enter the **Source** and **Destination** information for Path 2.

Select ST 2022-6 Video Settings

The Gamma and Color Gamut settings are the same for ST 2022-6 and 2110 video stream configurations, but the 2110 menu has a different layout. The settings define the characteristics of the video signal.

1. Under **ST2022-6**, select **Video**.
2. Select the **Gamma Curve** menu and choose the setting. The selection characterizes the video signal on each virtual input.

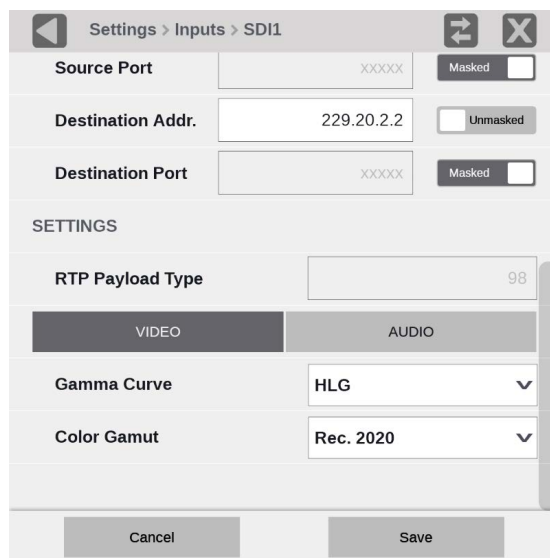

- **SDR Narrow:** The reference OETF (Optical to Electrical Transfer Function) is defined in ITU-R BT.709 with gamma of 0.45 and the reference EOTF (Electrical to Optical Transfer Function) is defined in ITU-R BT.1886 with gamma of 2.4.

The Narrow scaling places the extremes of the nonlinear color value from zero to unity at code words 40 hex (64 dec) and 3AC hex (940 dec) in a 10bit representation for 0% Black to 100% White. This range is typical for standard-dynamic range.

- **SDR Full:** The reference OETF is defined in ITU-R BT.709 with gamma of 0.45 and the reference EOTF is defined in ITU-R BT.1886 with gamma of 2.4.

The full scaling places the extremes of the nonlinear color value from zero to unity at code words 0d and 1023d in 10-bit representation and 0d and 4095d in 12-bit representation for 0% black and 100% white, respectively.

- **PQ Narrow:** The reference OETF with a high luminance range capability of 0 to 10,000 cd/m² standardized in ST 2084. The EOTF is the inverse of OETF.

The narrow Scaling places the extremes of the nonlinear color value from zero to unity at code words 40 hex (64 dec) and 3AC hex (940 dec) in a 10bit representation for 0% Black to 100% White. This range is typical for standard-dynamic range.

- **PQ Full:** The reference OETF with a high luminance range capability of 0 to 10,000 cd/m² standardized in ST 2084. The EOTF is the inverse of OETF.

The Full scaling places the extremes of the nonlinear color value from zero to unity at code words 0d and 1023d in 10bit representation and 0d and 4095d in 12-bit representation for 0% black and 100% white, respectively.

- **HLG:** The reference OETF is standardized in ARIB B67 and the reference EOTF is standardized in ITU BT.2100 at the nominal display peak luminance of 1000 nits.
- **S-Log2:** The reference OETF is defined as Sony S-Log2.
 - **S-Log3:** The reference OETF is defined as Sony S-Log3.
 - **S-Log3 (Live HDR):** The reference OETF is defined as Sony S-Log3.
 - **Log C:** The reference OETF is defined as ARRI Log C.

3. Select **Color Gamut** settings in the menu.

The selection is the color space of the video signal.

- **Auto:** The system selects the setting based on ST 352 VPID. If 352 VPID is not present, Rec. 709 is selected.
- **Rec. 709:** Standard for HD.
- **Rec. 2020:** Standard for 4K.

Note: Rec. 709 gamut is selected automatically when the SD format is detected or selected in the video signal.

Select ST 2022-6 Audio Settings

1. Under ST2022-6, select **AUDIO**.

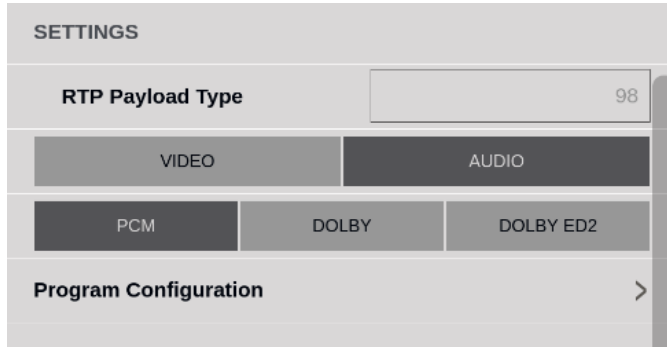

2. Configure one type of audio. See [Configure PCM](#), [Configure DOLBY](#), or [Configure DOLBY ED2](#) (use of Dolby requires the MP2-DLBY license).

Configure PCM

- A. Under **AUDIO**, select **PCM**.
- B. Select **Program Configuration**.
- C. Set the **Program Configuration** control to **On**.
- D. Select **Edit**. The Edit button disappears and the Default, Clear, and Undo buttons replace it.



E. Select the type of program (mono, stereo, etc.) and select the audio channel to assign it. Repeat until all the audio in the current input signal have programs assigned to channels.

- ◆ **M** is mono, one channel.
- ◆ **ST** is stereo, two channels.
- ◆ **5.1** is surround sound, six channels.

To change the channel order in the audio bars, see [5.1 Channel Order](#).

- ◆ **7.1** is surround sound, eight channels.
- ◆ **5.1.4** is immersive audio and requires 10 channels: six for the audio main bed, or level–marked in cyan, and four for the audio upper bed, marked in orange.

Note: 5.1.4 provides bar labels for the audio channels but is not available for downmix capability or for loudness display.

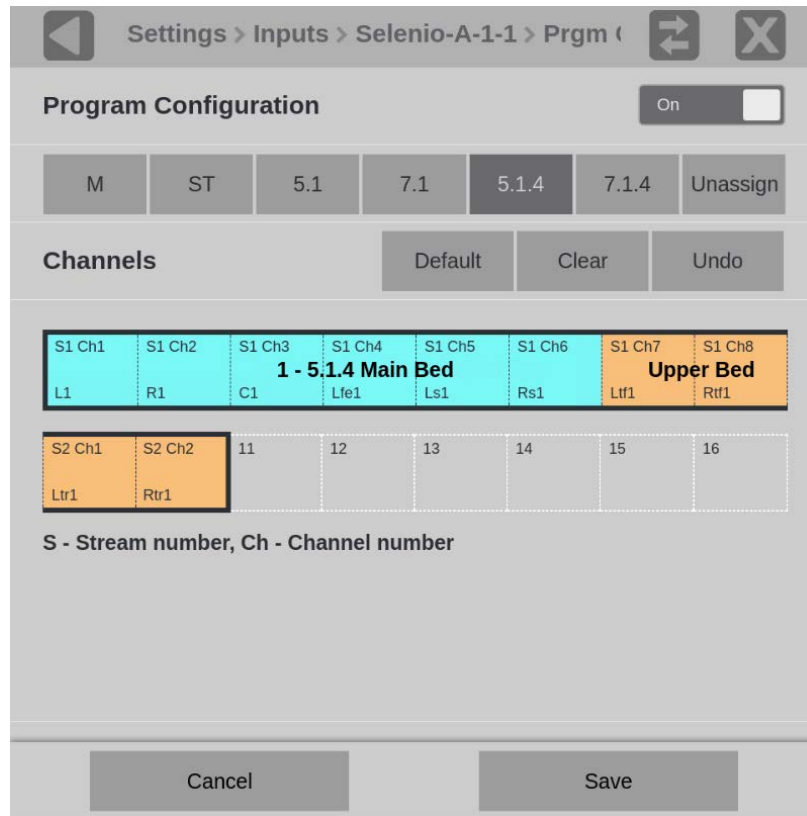

- ◆ **7.1.4** is immersive audio and requires 12 channels: eight for the audio main bed, or level–marked in cyan, and four for the audio upper bed, marked in orange.

Note: 7.1.4 provides bar labels for the audio channels but is not available for downmix capability or for loudness display.

- ◆ **Unassigned** removes an assignment from a channel. Select **Unassigned** and select any block in an assignment, for example select the middle of a 7.1 assignment and the entire assignment is removed and is not displayed on the Audio application.
- ◆ **Default** resets the channels to eight stereo pairs.
- ◆ **Clear** removes all assignments, including the default.

F. Select **Save** and close the menu.

Note: You must save the program configuration to update the programs in the audio bars and loudness meter.

Configure DOLBY

Note: Dolby selection works with Dolby D, D Plus, or E signals.

A. Under **AUDIO**, select **DOLBY**.

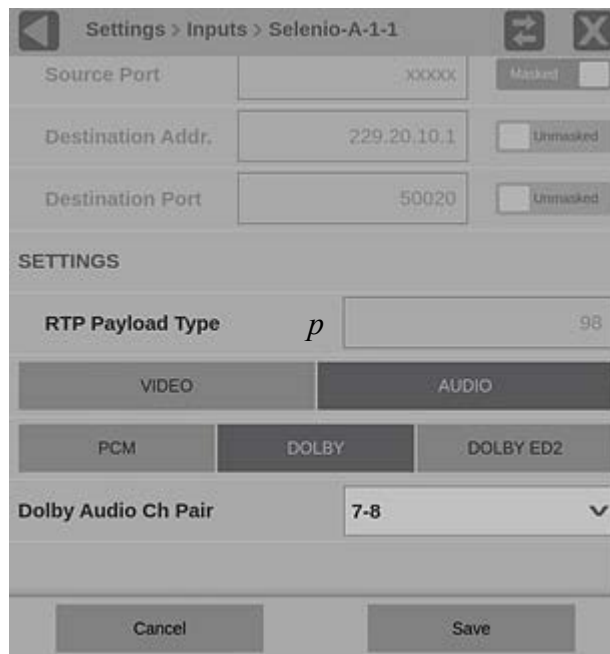

- B. In the **Dolby Audio Ch Pair** menu, select the audio channel pair that contains Dolby audio.
- C. If needed, identify Dolby Audio Channels, or go to Step D:
 - a. Open the Audio application.
 - b. Return to the **Input** menu and select the **PCM** option.
 - c. In the Audio application, in the audio levels, find and note the audio channels marked with either DOLBY D or DOLBY E.



d. In the **Input** menu, select the **DOLBY** option again.

e. In the **Dolby Audio Ch Pair** menu, select the channel pair that is marked as DOLBY in the Audio application. The audio bar layout is automatically configured based on the metadata in the Dolby stream.

D. Select **Save** and close the menu.

Note: Audio programs configured in the Program Configuration menu are used to select a program for measurement by the Loudness application, to display audio bars in the Audio application, and to monitor with headphones. When all the channels are unassigned, all the channels are treated as stereo pairs. The audio programs in the Dolby E stream are automatically set up based on the Dolby D/D Plus/E metadata.

Configure DOLBY ED2

A. Under **AUDIO**, select **DOLBY ED2**.

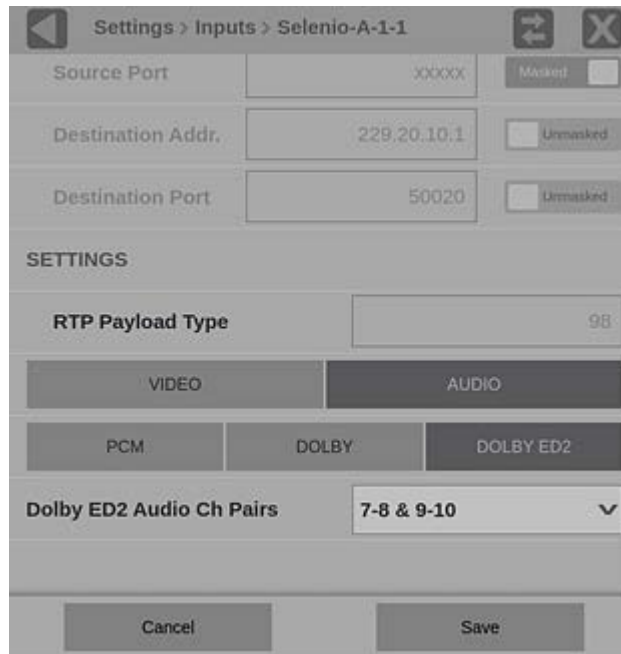

- B.** In the **Dolby ED2 Audio Ch Pairs** menu, select the consecutive channel pairs that contain Dolby ED2 audio.
- C.** If needed, identify the Dolby ED2 audio channels, or go to Step D:
 - a.** In the **Input** menu, select **PCM** (instead of DOLBY ED2).
 - b.** Open the Audio application.
 - c.** In the Audio application, in the audio levels, find and note the audio channels marked with "DOLBY ED2."

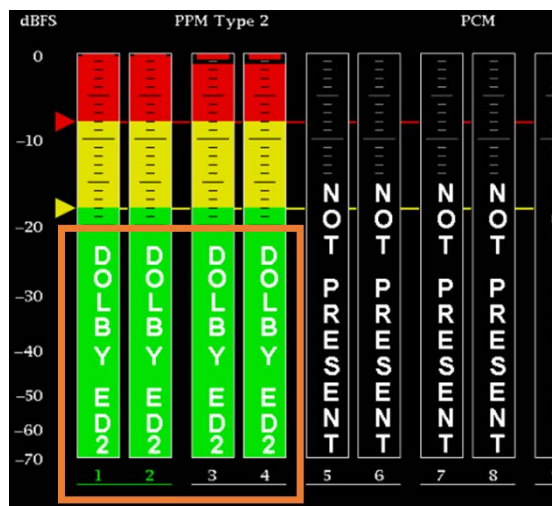

- d.** In the **Input** menu, select the **DOLBY ED2** option (instead of PCM).

- e. In the **Dolby ED2 Audio Ch Pairs** menu, select the channel pairs that are marked as DOLBY ED2 in the Audio application. Dolby ED2 metadata in the selected channels is decoded.

Note: When you select Dolby ED2 in the Input menu, the Audio application stops presenting data. This is expected; only Dolby ED2 metadata is supported.

- D. Select **Save** and close the menu.

Configure ST 2110

Note: If you are not using 2110, go to [Configure ST 2022-6](#).

Note: For remote configuration via NMOS, go to [Configure Inputs with NMOS](#).

1. Select the **Settings** icon ().
 2. Select **Inputs**.
 3. Select an input from the list.
 4. Select **IP** and then select **ST2110**.
 5. Set the **Seamless Switching** control to **Enabled** or **Disabled** as needed.
-

Note: For Seamless Switching, the two Path 1 and Path 2 streams should be identical. If the streams are not identical, error messages are shown in the Status Bar. There is a difference between “port” and “path”. The port is the physical SFP port that is used to input the 10GE signal. Path 1 and Path 2 are the signal paths to be used for seamless switching.

Note: With Seamless Switching, a reconstructed output stream is created from the two input streams. The reconstructed stream is used downstream for various display tiles like Picture. The buffer size to absorb the packet reception time difference between Path1 and Path2 is 10 ms. The output stream reconstruction does not work properly for streams on Path1 and Path 2 with skew greater than 10ms. This error makes Picture tiles show the wrong image.

Configure Video (2110-20/22) Stream

Note: Incoming 10-bit ST 2110-20 data is supported in the range 4-1019. Incoming data below the minimum is reduced to 4 and data above the maximum is reduced to 1019.

Note: Decoding 2110-22 requires the MPSPDP-JPXS license.

1. Under **ST2110**, select the **Video** tab.
2. Set the **Enable Video** control to **Enabled**.
3. In the Video Transport section, select the video transport protocol: **ST2110-20** or **ST2110-22**.



4. For each video stream, enter the information in **SFP Port**, **Source Addr**, **Source Port**, **Destination Addr.**, and **Destination Port**. If any fields are inaccessible (gray), set the Masked-Unmasked option to **Unmasked**.
5. Set **Ignore RTP Sequence Errors** to **On** if needed. This setting causes the instrument to ignore errors caused by out-of-order RTP packets; no events are generated. This is useful if incoming RTP packets are deliberately out of sequence.
6. Set the **RTP Payload Type** between 96 and 127.
7. Set the **Packet Read Schedule (PRS)** to **Gapped**, **Narrow Linear**, or **Wide Linear** to correctly measure the CMAX and VRX buffer measurements in the IP graphs.

Note: You can use the PIT Histogram to determine whether the signal is a gapped, narrow-linear, or wide-linear stream.

8. Set the **TR Offset**, which defines the timing reference offset of the sender for network delays. Select **Auto** to provide an offset based on the current video standard.
9. Select the **Gamma Curve** menu and choose the setting. The selection characterizes the video signal on each virtual input.

- **Auto:** The system selects the setting based on ST 352 VPID. If 352 VPID is not present, SDR Narrow is selected.
- **SDR Narrow:** The reference OETF (Optical to Electrical Transfer Function) is defined in ITU-R BT.709 with gamma of 0.45 and the reference EOTF (Electrical to Optical Transfer Function) is defined in ITU-R BT.1886 with gamma of 2.4.
The Narrow scaling places the extremes of the nonlinear color value from zero to unity at code words 40 hex (64 dec) and 3AC hex (940 dec) in a 10-bit representation for 0% Black to 100% White. This range is typical for standard-dynamic range.
- **SDR Full:** The reference OETF is defined in ITU-R BT.709 with gamma of 0.45 and the reference EOTF is defined in ITU-R BT.1886 with gamma of 2.4.
The full scaling places the extremes of the nonlinear color value from zero to unity at code words 0d and 1023d in 10-bit representation and 0d and 4095d in 12-bit representation for 0% black and 100% white, respectively.
- **PQ Narrow:** The reference OETF with a high luminance range capability of 0 to 10,000 cd/m² standardized in ST 2084. The EOTF is the inverse of OETF.
The narrow Scaling places the extremes of the nonlinear color value from zero to unity at code words 40 hex (64 dec) and 3AC hex (940 dec) in a 10-bit representation for 0% Black to 100% White. This range is typical for standard-dynamic range.
- **PQ Full:** The reference OETF with a high luminance range capability of 0 to 10,000 cd/m² standardized in ST 2084. The EOTF is the inverse of OETF.
The Full scaling places the extremes of the nonlinear color value from zero to unity at code words 0d and 1023d in 10-bit representation and 0d and 4095d in 12-bit representation for 0% black and 100% white, respectively.
- **HLG:** The reference OETF is standardized in ARIB B67 and the reference EOTF is standardized in ITU BT.2100 at the nominal display peak luminance of 1000 nits.
- **S-Log2:** The reference OETF is defined as Sony S-Log2.
- **S-Log3:** The reference OETF is defined as Sony S-Log3.
- **S-Log3 (Live HDR):** The reference OETF is defined as Sony S-Log3.
- **Log C:** The reference OETF is defined as ARRI Log C.

10. Select Color Gamut settings in the menu.

The selection is the color space of the video signal.

- **Auto:** The system selects the setting based on ST 352 VPID. If 352 VPID is not present, Rec. 709 is selected.
- **Rec. 709:** Standard for HD.
- **Rec. 2020:** Standard for 4K.

Note: NMOS/SDP files coerce these parameters from Auto.

Note: Rec. 709 gamut is selected automatically when the SD format is detected or selected in the video signal.

VIDEO SETTINGS

Ignore RTP Sequence Errors Off

RTP Payload Type

Packet Read Schedule (PRS) Gapped Narrow Linear Wide Linear

TR Offset (µs) Auto

Gamma Curve ▼

Color Gamut ▼

11. If needed, set the **Format Detection** to **Manual**.

Note: Manual Format Detection is required for 2110 Fast Switching and MULTI Input when IP sources are used. See [Set for 2110 Fast Switching](#).

12. Select the **Resolution** field and set the resolution.

13. Select the **Frame Rate** field and set the frame rate.

14. If the **Structure** option is available, select the field to change to RGB 4:4:4 12bit as needed.

Note: Only some resolutions and frame rates allow the Structure to be RGB 4:4:4 12bit.

Gamma Curve	HLG
Color Gamut	Rec. 2020
Format Detection	Manual <input type="checkbox"/>
Resolution	1920x1080
Frame Rate	59.94p
Structure	YCbCr 4:2:2 10bit

Cancel Save

15. Select **Save** to save the options you selected.

Configure Audio (2110-30 / 31) Stream

Note: To decode audio (2110-30 /31) stream, video (2110-20) must be available and subscribed.

Note: Audio programs must be in a single audio stream for loudness, downmix, and surround display.

1. Under **ST2110**, select the **Audio (2110-30 / 31)** tab.
2. Select anywhere in the stream # row to configure (1-4).

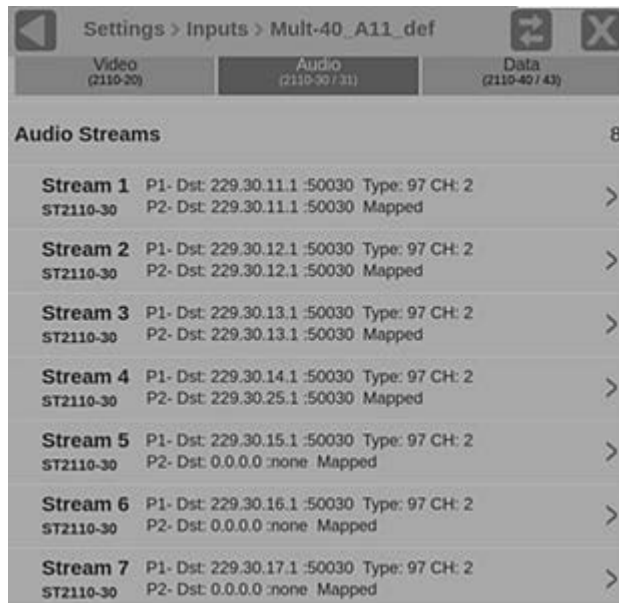

3. Set the **Enable Audio Stream** control to **Enabled**. This subscribes the audio stream from the media switch.
4. Set the **Map Stream #** control to **Enabled**. This makes the audio stream appear in the Audio applications.
5. Set the audio transport protocol; select **2110-30** or **2110-31** in **Audio Transport**.

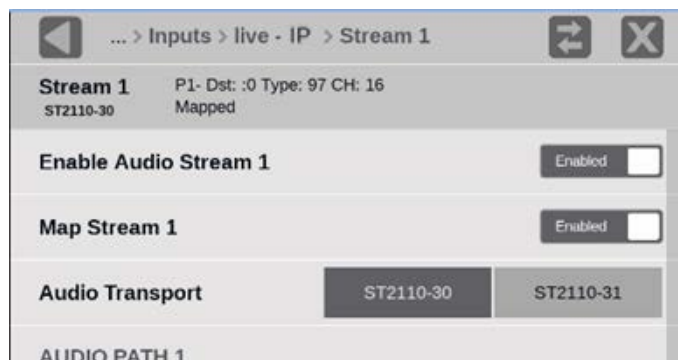

Note: 2110-30 or 2110-31 can carry PCM or Dolby D, D Plus, or Dolby E, but if 2110-30 will carry Dolby content, the data must be transmitted in pairs and set to start on odd channels such as 1-2 or 3-4.

Note: Only a single stream can be set for 2110-31; one to four streams may be 2110-30, up to a total of eight audio streams, with a maximum of 16 audio channels total.

6. In the **SFP Port** box, type the port number.

Note: The SFP (physical) Port configuration is common for video, audio, and data.

7. In the **Destination Addr.** box, type the address.

Note: The Source Addr, Source Port, and Destination Port are optional if the IP stream is uniquely specified.

The screenshot shows a configuration window titled "AUDIO PATH 1". It contains the following fields and controls:

- SFP Port:** A dropdown menu with "1" selected. Below the field is the text "Video / Audio /Data".
- Source Addr.:** A text input field containing "xxx.xxx.xxx.xxx" and a "Masked" checkbox which is checked.
- Source Port:** A text input field containing "xxxxx" and a "Masked" checkbox which is checked.
- Destination Addr.:** A text input field containing "239.31.10.19" and an "Unmasked" checkbox which is unchecked.
- Destination Port:** A text input field containing "xxxxx" and a "Masked" checkbox which is checked.

8. Set the **RTP Payload Type** between 96 and 127.

Note: The RTP Payload Type is displayed in the IP Status application.

9. Set the number of channels in the audio stream between 2 and 16. The number of channels must be an even number (2, 4, 6, etc.). A maximum of 16 audio channels, across all audio streams, are supported.

10. Set **Packet Timing** as needed; Auto is recommended.

Note: If an audio programs uses multiple streams, all streams must have the same packet timing.

Note: The Bit Depth is already set to 24.

Note: If you are using an MPI or MPX (not an MPI2 or MPX2) that is upgraded with a 25G multi-media board, some audio functions (surround display, loudness, headphone downmix) are not available if the audio program uses (spans) multiple streams.

11. Select **Save Stream #**.

AUDIO SETTINGS

RTP Payload Type	97
Num of Channels	4
Packet Timing	Auto 83 μ s 125 μ s 1 ms
Bit Depth	24

Cancel Save Stream 1

12. Repeat Steps 1-11 for each stream to configure. You can configure up to four audio streams as required, maintaining a total of 16 audio channels.
13. Under Audio (2110-30 / 31), configure one type of audio. See [Configure PCM](#), [Configure DOLBY](#) or [Configure DOLBY ED2](#): (use of Dolby requires the MP2-DLBY license).

Stream 4 P1- Dst: 229.30.14.1 :50030 Type: 97 CH: 4
ST2110-30 P2- Dst: 229.30.14.1 :50030 Mapped

PCM DOLBY DOLBY ED2

Program Configuration

Cancel Save

Configure PCM

- A. Under **AUDIO**, select **PCM**.
- B. Select **Program Configuration**.
- C. Set the Program Configuration control to **On**.
- D. Select **Edit**. The Edit button disappears and the Default, Clear, and Undo buttons replace it.

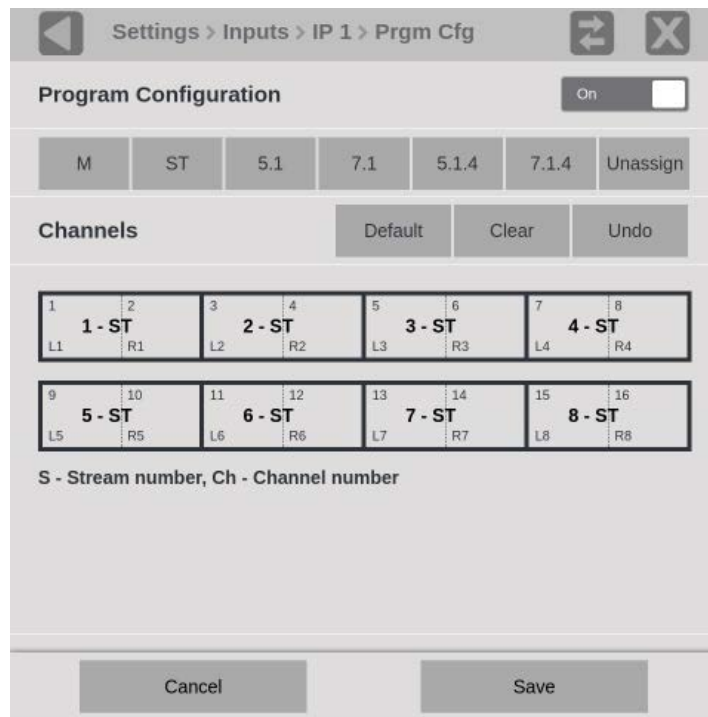

E. Select the type of program (mono, stereo, etc.) and select the audio channel to assign it. Repeat until all the audio in the current input signal have programs assigned to channels.

- ◆ **M** is mono, 1 channel.
- ◆ **ST** is stereo, 2 channels.
- ◆ **5.1** is surround sound, 6 channels.
 To change the channel order in the audio bars, see [5.1 Channel Order](#).
- ◆ **7.1** is surround sound, eight channels.
- ◆ **5.1.4** is immersive audio and requires 10 channels: six for the audio main bed, or level-marked in cyan, and four for the audio upper bed, marked in orange.

Note: 5.1.4 provides bar labels for the audio channels but is not available for downmix capability or for loudness display.

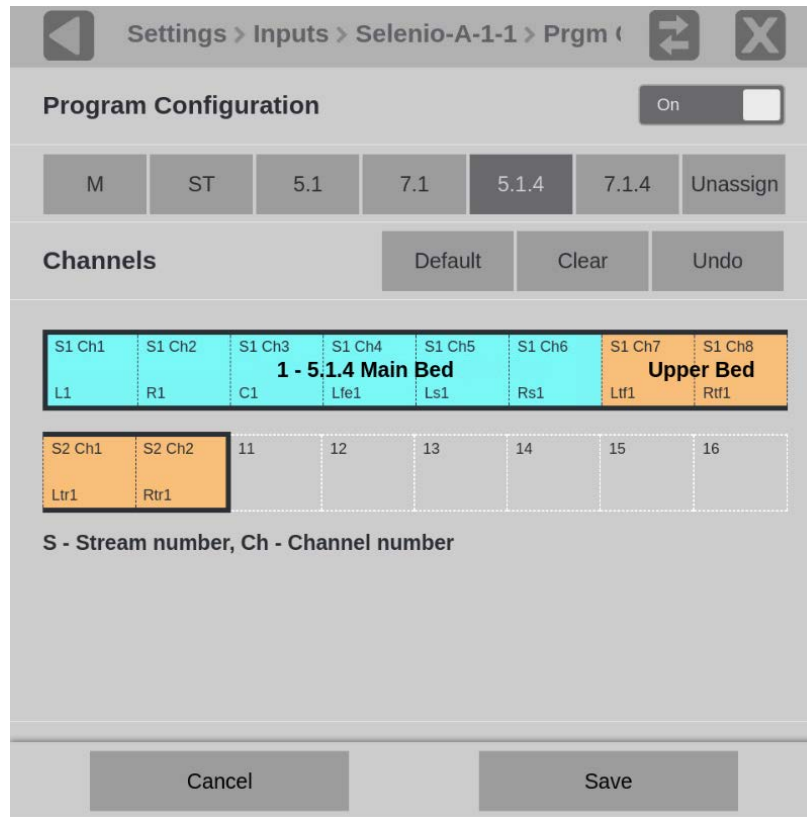

- ◆ **7.1.4** is immersive audio and requires 12 channels: eight for the audio main bed, or level–marked in cyan, and four for the audio upper bed, marked in orange.

Note: 7.1.4 provides bar labels for the audio channels but is not available for downmix capability or for loudness display.

- ◆ **Unassigned** removes an assignment from a channel. Select **Unassigned** and select any block in an assignment, for example the middle of a 7.1 assignment, the entire assignment is removed and is not displayed on the Audio application.
- ◆ **Default** resets the channels to eight stereo pairs.
- ◆ **Clear** removes all assignments, including the default.

F. Select **Save** and close the menu.

Note: You must save the program configuration to update the programs in the audio bars and loudness meter.

- G. If necessary to continue configuring the instrument, see [Configure Data \(2110-40/43\) Stream](#).

Configure DOLBY

Note: Dolby selection works with Dolby D, D Plus, or E signals.

Note: To use Dolby in 2110, the Audio Transport, in the audio stream, must be configured as 2110-31.

A. Under **AUDIO**, select **DOLBY**.



B. In the **Dolby Audio Channel Pair** menu, select the audio channel pair that contains Dolby audio.

C. If needed, identify Dolby Audio Channels, or go to Step D:

a. Open the Audio application.

b. Return to the **Input** menu and select the **PCM** option.

- c. In the Audio application, in the audio levels, find and note the audio channels marked with either DOLBY D or DOLBY E.



- d. In the **Input** menu, select the **DOLBY** option again.
 - e. In the **Dolby Audio Ch Pair** menu, select the channel pair that is marked as DOLBY in the Audio application. The audio bar layout is automatically configured based on the metadata in the Dolby stream.
- D.** Select **Save** and close the menu.

Note: Audio programs configured in the Program Configuration menu are used to select a program for measurement by the Loudness application, to display audio bars in the Audio application, and to monitor with headphones. When all the channels are unassigned, all the channels are treated as stereo pairs. The audio programs in the Dolby E stream are automatically set up based on the Dolby E metadata.

Note: The number of audio streams and channels determines the content and order of audio channels embedded in the AUX OUT.

Note: If the number of audio channels present does not complete a group (4 channels) the remaining channels in the group are labeled "Z BIT".

Note: If the audio bars are flashing in the audio display, or sounds are garbled or the wrong pitch, it is possible that the audio input configuration is not set up correctly. Check the IP address, port, and payload type from the IP session display and make sure to select the correct number of audio channels. A guideline for the number of audio channels (assuming 24-bit, 48kHz audio) is approximately 1 to 1.5 Mb/s per channel. See the IP Status BITRATE column.

Note: To receive only audio, disable the video stream.

- E. If necessary to continue configuring the instrument, see [Configure Data \(2110-40/43\) Stream](#).

Configure DOLBY ED2:

- A. Under **AUDIO**, select **DOLBY ED2**.



- B. In the **Dolby ED2 Audio Ch Pairs** menu, select the audio channel pairs that contains Dolby ED2 audio.
- C. If needed, identify the Dolby ED2 audio channels, or go to Step D:
 - a. In the **Input** menu, select **PCM** (instead of DOLBY ED2).
 - b. Open the Audio application.
 - c. In the Audio application, in the audio levels, find and note the audio channels marked with "DOLBY ED2."

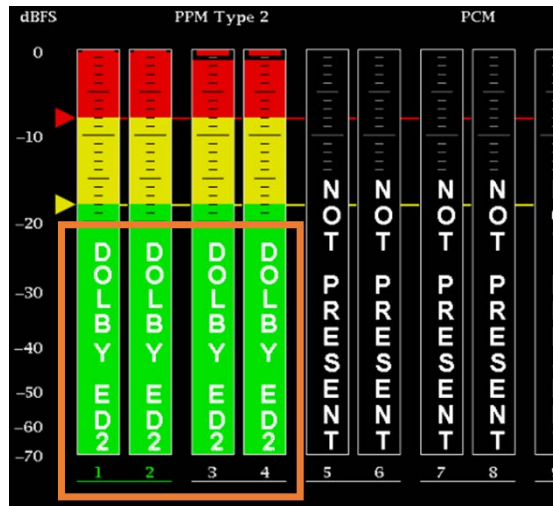

- d. In the **Input** menu, select the **DOLBY ED2** option (instead of PCM).
- e. In the **Dolby ED2 Audio Ch Pairs** menu, select the channel pairs that are marked as DOLBY in the Audio application. Dolby ED2 metadata in the selected channels is decoded.

Note: When you select Dolby ED2 in the Input menu, the Audio application will stop presenting data. This is expected; only Dolby ED2 metadata is supported.

- D. Select **Save** and close the menu.
- E. If necessary to continue configuring the instrument, go to the next section.

Configure Data (2110-40/43) Stream

1. Select the **Data** tab.
2. Select anywhere in the **Stream** row to configure (1-4).



3. Set the **Enable Data** control to **Enabled**.



4. Select the **Data Transport** type: **ST2110-40** or **ST2110-43**.

Note: 2110-43 is the TTML Subtitles transport.

5. For each data stream, enter the information in the **SFP Port**, **Source Addr**, **Source Port**, **Destination Addr**., and **Destination Port** boxes.

6. Set the **RTP Payload Type** between 96 and 127.

Note: The RTP Payload Type number must be unique for each IP stream. The RTP Payload Type is displayed in the IP Status application.

Keep Alive packets are required to keep TTML decoding synchronized with the rest of the ST 2110 stream.

7. Select **Save** and close the menu.

Configure RTP

Monitoring general purpose RTP streams allows you to see physical and IP layer measurements, but none of the video, audio, and data payload is decoded and displayed.

Monitor general-purpose RTP streams:

1. Select the **Settings** icon (⚙️).
2. Select **Inputs**.
3. Select the input from the list.
4. Select **IP** and then select **RTP**.

Settings > Inputs > SDI1

Name ⓘ SDI1

IP SDI

ST2022-6 ST2110 RTP

SFP Port 1

Source Addr. xxx.xxx.xxx.xxx Masked

Source Port xxxxxx Masked

Destination Addr. 229.20.2.2 Unmasked

Destination Port 50011 Unmasked

SETTINGS

Cancel Save

5. In **SFP Port**, select the port to monitor.
6. Enter **Source** and **Destination** information.
7. Set the **RTP Payload Type** between 0 to 127.
8. Select the **Video Format** and corresponding **Frame Rate**.
9. Select **Save** and close the menu.

Select Input



Two modes are supported:

- **Single Input mode:** Select any single input to monitor from an IP or SDI signal.
- **Multi-input mode:** Select multiple SDI or IP (ST2110-20 or ST2110-22) inputs to simultaneously monitor up to four virtual inputs. Option MP2-MULTI is required.

Single Input Mode

To select a single configured input from an IP or SDI signal:

Note: If the MP2-MULTI option is not installed, multiple inputs is not available, "Multi:" is not in the Input menu, and only single input mode is available.

1. Check the Single Input mode is enabled:
 - A. Select the **Settings** icon () and then select **Input**.
 - B. Set Multi Mode to **Off**.
2. Select the **Input** icon () from the status bar at the bottom of the PRISM monitor.
3. Select a configured input from the list in the Input bar.



4. Select the **Home** icon () to close the Input selection controls.

Multiple Inputs Mode

Multi-Input mode can simultaneously monitor up to four SDI or IP (2110-20 or 2110-22) inputs. When using Multi-Input mode there is a primary channel and up to three secondary channels

Primary Channel

The primary channel is the main input of the four possible inputs. It can be reassigned at any time. The current primary channel is marked in the Multi Input menu and the status bar with a cyan dot.

Alarms, Audio Output, and SDI Aux are supported only for the primary channel.

Secondary Channels

The secondary channels are any selected channel that is not the primary. These are marked in the multi-input menu and status bar with white dots. These inputs cannot be displayed in primary-only applications but are displayed in all other applications unless otherwise noted. If a secondary channel is assigned to a tile with a primary-only

application (or a secondary channel is assigned a primary-only application), the tile displays a message that it cannot display the application on a secondary channel.

Selecting Multiple inputs

1. Select the **Input** icon () from the status bar at the bottom of the PRISM monitor.
2. Select the multi-input menu button from the Input bar.

Note: If “Multi:” is not in the Input menu and the Multi menu button is not active, the MP2-MULTI option might not be installed.



3. Set Multi Input to **ON**.
4. Set Edit Mode to **ON**.

When Edit mode is OFF:

- No individual input menus appear when you select an input button.
- Selecting an input applies the selected input without confirmation.
- Selecting an input changes that input to the primary channel.
- The options in the multi-input menu are not available (the inputs in the tiles and the selected channels cannot be changed).

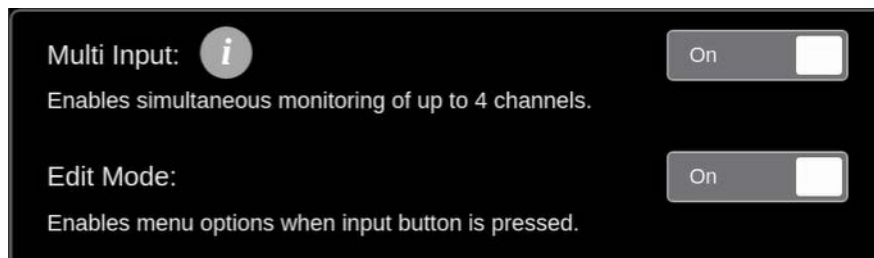

5. Assign inputs to one of four channels:

Note: If no channels have been selected, the first virtual input (left channel on the Input menu) is automatically set as the primary and shown on all the tiles.

- A. Select an input from the Input bar. The input menu opens.
- B. In the menu, select **Add Channel**.

The example shows SDI-In 1 is the primary channel (cyan dot) with number indicated virtual channel and SDI-In 2 is unselected.

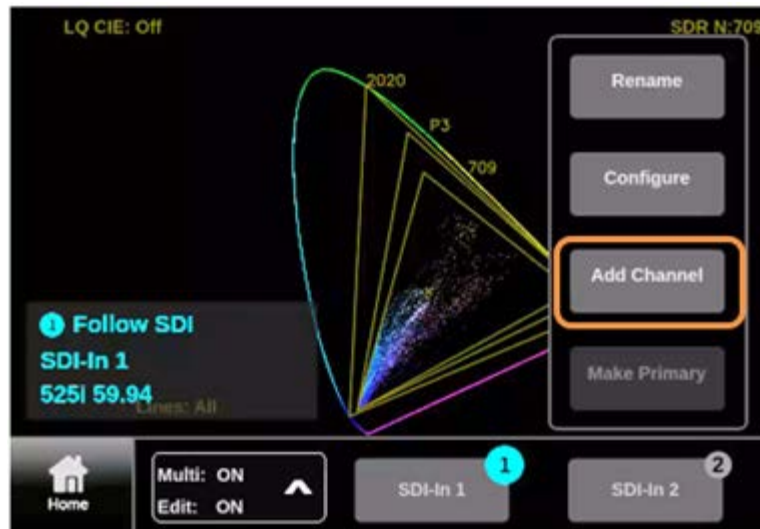

The input appears in the list of channels with a white dot and virtual input number.

Note: If there are already four inputs selected, an error message appears. Follow the instructions in the message to remove a channel.

C. Repeat Steps A and B until all the needed channels are selected.

Change Primary Channel

One of the inputs must be the primary channel. The primary channel is initially set to the active input from single input mode.

To reassign the primary channel:

1. Select one of the secondary channels marked with a white dot (the potential primary channel must be selected as a monitored channel). The input menu opens.
2. Select **Make Primary** from the menu.

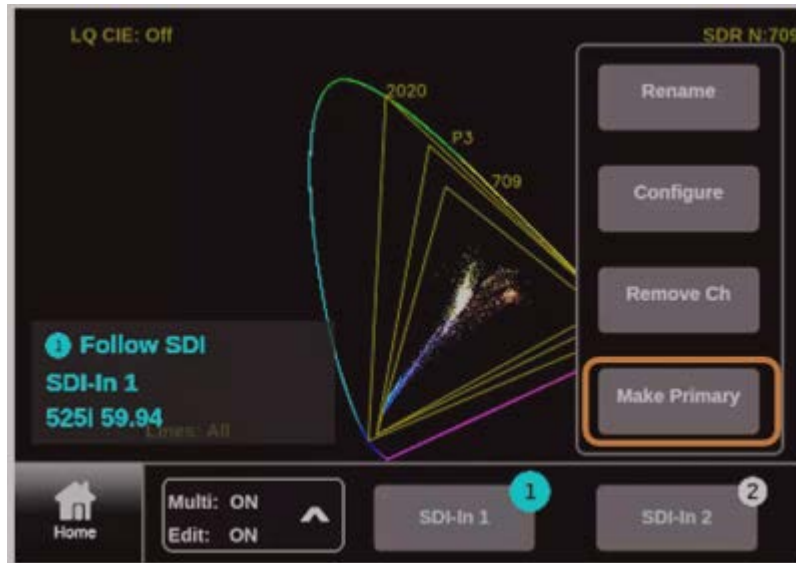

The selected secondary input becomes primary and the primary becomes a secondary; the white dot turns cyan and the cyan dot turns white. In the multi-input menu, the titles in the tiles change color and any tiles set to Follow Primary change to the selected input.

Follow Primary means a tile input configuration follows the primary input, no matter what input is selected as the primary. If a secondary input is changed to primary, all tiles set to Follow Primary change to the new primary input.

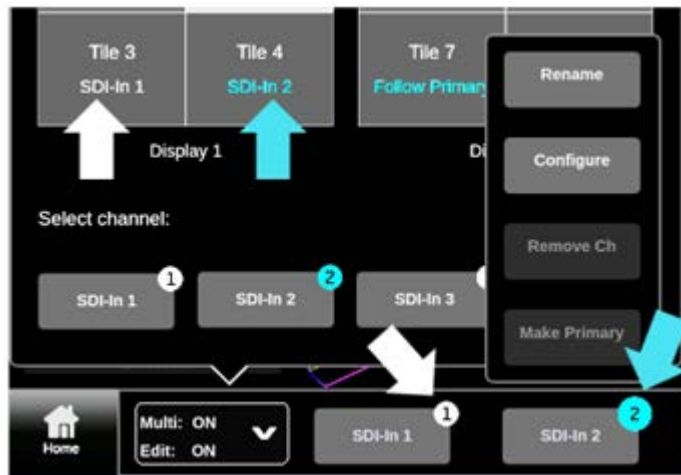

Note: Because the primary input becomes a secondary input, if a tile that is now using a secondary input has a primary-only application, the tile displays a message that the application cannot work with a secondary channel.

Configure Input Tiles

To set the Multi Input tiles to display specific inputs:

1. In the tile map, select a Tile 1-4, or 1-8 if there is an extended display (8 tiles also requires the option MP2-EXTNDSP).
2. Click each tile that you want to use for the selected input, and then select the channel for that input to be applied to each tile.
3. Select the input to display from the list of selected inputs at the bottom of the Multi menu or select Follow Primary.

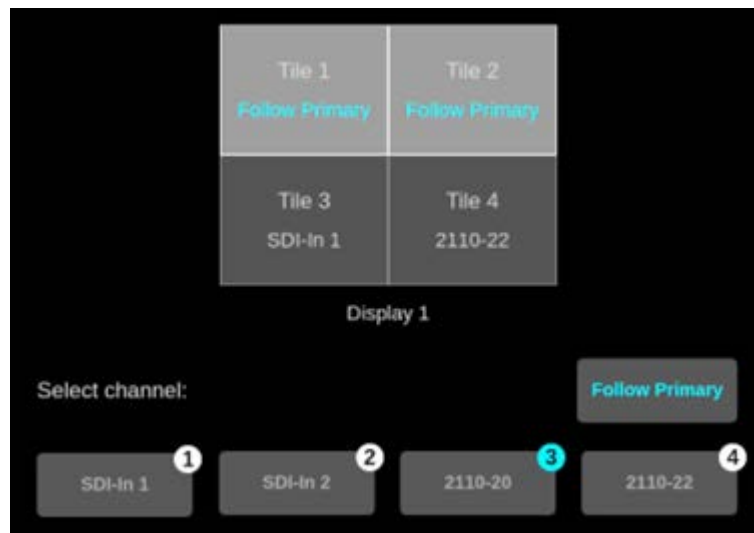

The labels in the tiles show the name of the selected input (such as SDI-In 1), it also shows if they are following the primary (the tile label shows “Follow Primary”). If the selected input is the primary channel, the tile information is in cyan.

Reset Tile Map

To reset the Multi Input tile map back to default:

1. In the **Multi** menu, select **Reset**. Reset sets all the tiles in the tile map to Follow Primary, it sets channel 1 (the input at the far left of the input menu) as the primary, and it removes all selected inputs from the channels list (no other inputs are selected for monitoring). It leaves the previously selected applications in the tiles but they are all set to monitor the primary input.
2. Select the multi-input menu button to close the menu.

Operation with ST 2110

Inputs may be configured for ST 2110 either manually or with NMOS (see [Configure ST 2110](#) and [Configure Inputs with NMOS](#)).

Note: ST 2110 audio and data are only supported on the primary input. Any 2110-30/31 or 2110-40/43 streams configured for secondary inputs will not be joined.

For ST 2110-20 or ST 2110-22 streams, the input must be configured for manual format detection.

- For NMOS operation, the format detection is set using the SDP file.
- If the format of the stream is unknown, switch to single input mode and set format detection to Auto. Use the format reported in the status bar to then set the manual format detection for each input.
- When finished, set **Multi Input to On**.

The two SFP IP ports support up to 25Gb of IP traffic, depending on the data rate of your network. When monitoring multiple ST 2110 inputs, you must configure inputs so that a stream won't overflow the port. You may use up to 95% of the available link bandwidth.

From the input settings:

- You may use 2022-7 Seamless Switching if desired, although it may limit the number of simultaneous virtual inputs you can use, due to twice the bandwidth required.
- If Seamless Switching is disabled, select which SFP port will be used for each input, 1 or 2.

Note: Video/Audio/Data for an input must all use the same SFP port.



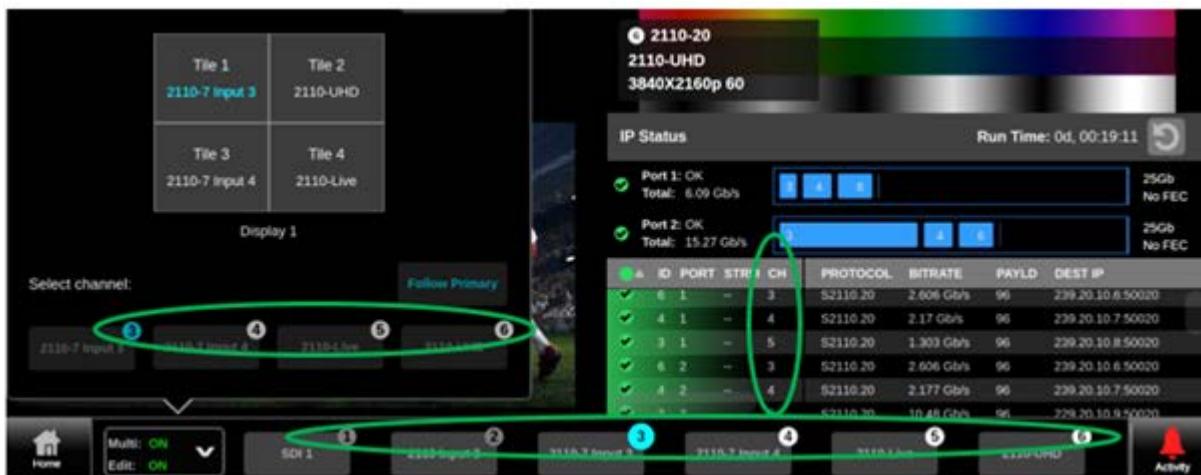

The IP Status application displays the virtual input channel each stream is mapped to.

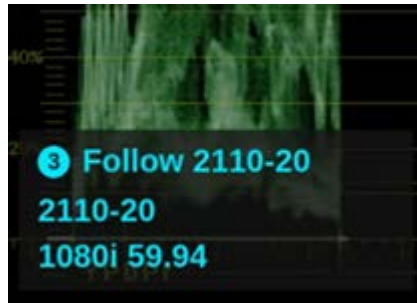

Adjust Source Label

The input information (label) in the tile contains the name of the input it is set to monitor (like SDI-In 2), if the tile is following the primary, the signal transport, and the frame rate of the input.



To open the Source Label controls, select the **Settings** icon () and then select **Display**.

- To move the Source Labels, open the Source Label Position menu and select the location for the label from the options. You can also select-and-drag the label to one of four locations (bottom left or right, top left or right).
- To set the Source Label timeout, open the **Source Label Timeout** menu, and select when and how the label should appear.
- To show hidden labels or brighten dimmed, select the **Home** icon ()

If the primary input is missing, or if any secondary input frame rates are incompatible with the primary input (for example an input of 1080i/59 is incompatible with an input of 1080i/50), the trace applications will function but might have reduced trace quality.

Multi-Input Applications

In using applications with multiple inputs, there are some limitations. Several applications work only with the chosen primary channel.

Primary-only applications:

- Video Session
- Audio
- Dolby Status
- AES Channel Status
- IP Session
- IP Graphs
- PIT Histogram
- Stream Timing
- ANC Session
- Datalist

- Timing
- AV Delay

Note: These primary-only applications are marked with a cyan dot when the Multi Input mode is on. The applications are marked in the application bar and the All Applications menu.

IP applications that are not tied to IP Inputs are functional in Multi Input mode:

- IP Status
- IP Session (Layer 1/2 and PTP tabs)
- PTP Graphs

Note: These Picture application functions are available only to the primary channel: Convert to Rec. 709, Source ID Overlay, Closed Caption, HDR Measurements, and Lightmeter.

Set for 2110 Fast Switching

This procedure sets up the instrument for 2110 fast switching between inputs. This mode enables a make-before-break setting for 2110 signals. The system subscribes to the second video stream, switches at the marker bit, and then unsubscribes from the first stream.

Twice the bandwidth is required to handle two IP streams during input transitions. If there is insufficient bandwidth for the make-before-break operation, the system will drop packets during the transition. In this situation you might want to disable this feature. This condition will likely occur for 4K/50p signals on a 10G network or if there are other signals on the link that would reduce the bandwidth to be insufficient for make-before-break operation.

Fast Switching Benefits:

- Switching 2110 inputs is much faster.
- Switching between inputs displays complete frames on the picture application.
- It reduces switching errors in the Event Log and IP Graphs.
- SDI Aux out switches between the two sources with no CRC errors.
- SDI Aux out seamlessly switches between the two sources.

Prerequisites for 2110 Fast Switching:

- Signals to fast switch must be the same exact resolution, frame rate, and structure or fast switching is not possible.

- Set the virtual inputs being fast switched to the Resolution, Frame Rate, and Structure of the signals, or for NMOS applications the format specified in the SDP file.

Note: If the Resolution and Frame Rate of the input does not match the actual signal, the Picture could produce false images to the point of being unusable.

Note: 2110 Fast Switching is not supported in Multi Input mode.

- 2110-20 video inputs must be locked to PTP and well timed.
 - PRISM will tolerate a maximum skew between the streams up to 500 microseconds with the skew taking into account jitter and delay.
 - The aux out jitter specification must be met for each stream if the AUX OUTPUT Loop-through is enabled.
- For best switching time performance:
 - Streams should have the same Packing Mode: Block or General.
 - Streams should have the same Packet Read Schedule (PRS): Gapped or Linear.
 - Streams should be 2110-21-compliant.

When a PRISM receives a new stream that does not meet the prerequisites, fast switching might not be possible.

Set 2110 Fast Switching through NMOS

Activate the video receiver with an SDP file containing the appropriate format information. The format information for video is defined in the *a=fmtp* line.

Required Media Type Parameters

Include the payload-format-specific Media Type parameters in the *a=fmtp* clause of the SDP for all streams conforming to this standard. This sample is a part of an SDP file.

```
v=0
o=- 123456 2 IN IP4 0.0.0.0
s=Sample video SDP file (ST 2110-20 with ST 2022-7)
i=1080p@50 Hz video streams
t=0 0
a=group:DUP first second
a=recvonlym=video 20000 RTP/AVP 96
i=First video stream description
c=IN IP4 239.20.10.113/8
a=rtpmap:96 raw/90000
a=mid:first
```

```
a=fmtp:96 sampling=YCbCr-4:2:2; width=3840;  
height=2160; exactframerate=60000/1001; depth=10; TCS=SDR;  
colorimetry=BT2020; PM=2110GPM; TP=2110TPN; SSN=ST2110-20:2017;  
a=ts-refclk:localmac=98-03-9B-A0-88-83  
a=mediack:direct=0  
m=video 20000 RTP/AVP 96  
i=Second video stream description  
c=IN IP4 239.20.20.113/8  
a=rtpmap:96 raw/90000  
a=mid:second
```

```
a=fmtp:96 sampling=YCbCr-4:2:2; width=3840;  
height=2160; exactframerate=60000/1001; depth=10; TCS=SDR;  
colorimetry=BT2020; PM=2110GPM; TP=2110TPN; SSN=ST2110-20:2017;  
a=ts-refclk:localmac=98-03-9B-A0-88-82  
a=mediack:direct=0
```

sampling: Signals the color difference signal sub-sampling structure. Possible values are YCbCr-4:2:2 and RGB-4:4:4.

depth: Signals the number of bits per sample. Possible values are 10 or 12.

width: the number of pixels per row. Permitted values are integers between 1 and 32767 inclusive. PRISM supports 720, 1280, 1920, and 3840.

height: the number of full-bandwidth sample rows per frame. Permitted values are integers between 1 and 32767 inclusive. PRISM supports 486, 576, 720, 1080, and 2160.

exactframerate: the frame rate in frames per second. Integer frame rates are written as a single decimal number (for example 25). Non-integer frame rates are written as a ratio of two integer decimal numbers separated by a forward-slash (for example 30000/1001) using the numerically smallest numerator value possible. PRISM supports 24000/1001, 24, 25, 30000/1001, 30, 50, 60000/1001 and 60.

colorimetry: the system colorimetry used by the image samples. Supported values are BT709, BT2020, and UNSPECIFIED. UNSPECIFIED means the PRISM uses whatever value was manually set (see the Color Gamut menu).

Media Type Parameters with Default Values

Senders can include the format-specific Media Type parameters in the *a=fmtp* clause of the SDP for all streams using this standard.

- **interlace:** If this parameter name is present, it means the video is interlaced, or the video is Progressive segmented Frame (PsF). If this parameter name is not present, the progressive video format is used.
- **segmented:** If this parameter name is present, and the interlace parameter name is also present, then the video is a Progressive segmented Frame (PsF). Using this parameter without the interlace parameter is not possible.

- **TCS:** Transfer Characteristic System; this parameter specifies the transfer characteristic system of the image samples (in the Gamma Curve menu in the settings for an input). Supported values are SDR, PQ, HLG, and UNSPECIFIED. If the TCS value is unspecified, receivers use the value SDR. UNSPECIFIED means the PRISM uses whatever value was manually set (see the Gamma Curve menu).

These attributes determine the PRISM settings. These all correspond to one of the format menus:

- The TCS attribute sets the Gamma Curve.

Note: For SDR and HLG, these are always narrow for 2110.

- The colorimetry attribute sets the Color Gamut.
- The width and height attributes set the Resolution.
- The exactframerate attribute—and the presence or absence of the interlace and segmented attributes—set the Frame Rate.

Set 2110 Fast Switching Through UI

1. Select the **Settings** icon () and then select **Inputs**.
2. Set the 2110 Fast Switching to **On**.



3. Set up the first IP input. See [Configure ST 2110](#) for how to set up an IP 2110 input.
4. In the Input set Format Detection to **Manual**.

Note: Setting Format Detection to Auto is not effective for fast switch; the setting must be made manually.

5. Set the Resolution, Frame Rate, and Structure (if the option is available) to the same settings as the signal. See [Prerequisites for 2110 Fast Switching](#): for requirements of setting up inputs for fast switching.

Note: If the Resolution and Frame Rate (and any Structure) of the input does not match the actual signal, the Picture could produce false images to the point of being unusable.

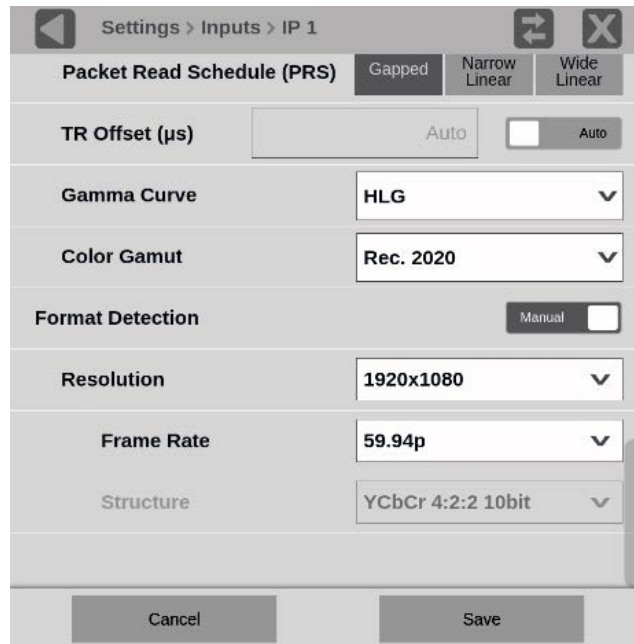

- A. Find the resolution and frame rate of the incoming signal; set the Format Detection to **Auto** and select **Save**.
- B. Open the **Video Session** application.

The resolution, frame rate, and structure are listed near the top of the tile.

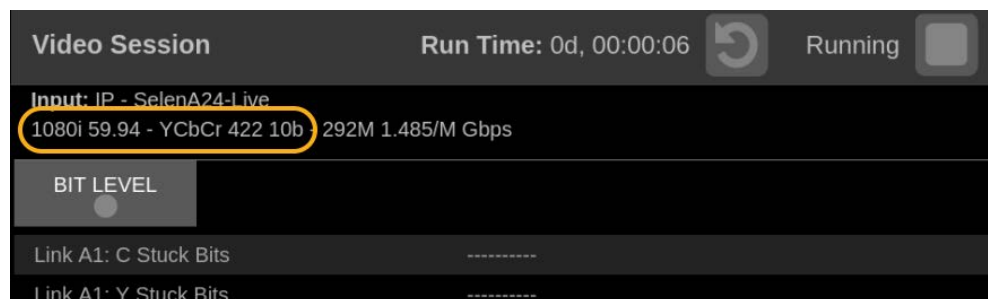

displays. The conversion between input video and linear light is processed in Scene light.

Note: Convert to Rec. 709 mode is not supported for SD signals.

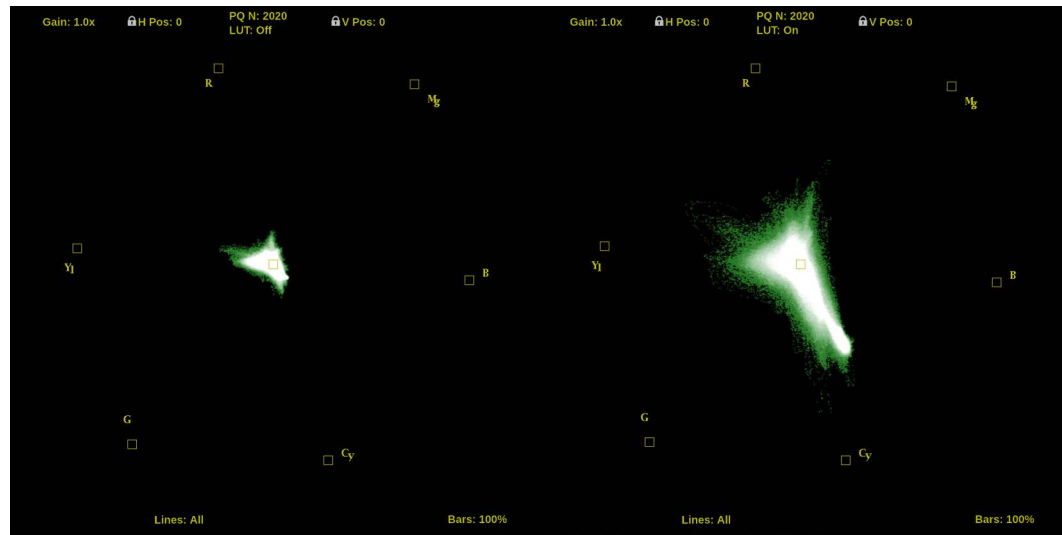

Using NMOS

NMOS (Networked Media Open Specifications) allows system integrators to build an IP system with PRISM being managed by system management software. The software discovers, registers, and configures inputs for monitoring. The NMOS implementation is compatible with IS-04 discovery and registration, and IS-05 device connection management.

You can choose DNS or Static (manual) IP addresses when configuring the NMOS Registration Server. Static IP addressing ensures consistent connectivity, improved network security for implementation of access control lists, firewall rules, and establishing Quality of Service (QoS) rules.

Enable NMOS Discovery and Registration

To enable NMOS on your instrument:

1. Select the **Settings** icon ().
2. Select **Network**.
3. Select **NMOS** in the Network menu.



4. Set the **Enable NMOS Discovery & Registration** control to **Enabled**.
5. Set the **NMOS Discovery Version** to **Version 1.2** or **Version 1.3**, according to the system management software. For details of version 1.3, see [NMOS Specifications](#).
6. Set **NMOS DNS** to **Auto**, **Multicast**, or **Unicast** as needed.

Note: PRISM checks for DNS registry announcements to find an NMOS registry. In case of multiple registries, the PRISM attempts to register with the NMOS registry with the highest priority (0 is highest). If NMOS DNS is set to Auto, all Multicast and Unicast registry announcements are considered. Selecting Multicast or Unicast shows only that type of registry announcement.

7. If you chose Static in Step 6:
 - A. Set the **NMOS Registration Method** to **Static**.
 - B. Set the desired static **NMOS Registry Address** and **Port**. You can view the Static NMOS Registry status on the IP Session NMOS tab. If PRISM is successfully registered, the LED will be green.

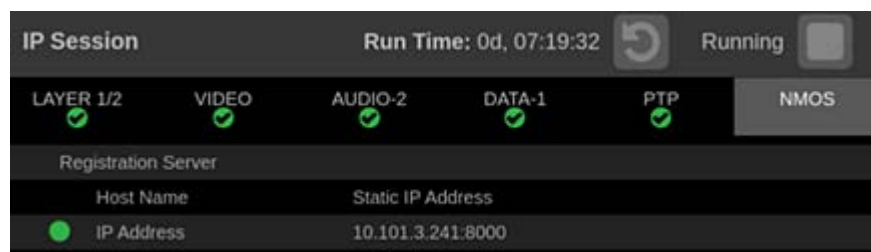

Note: The Advertised Port is the physical port on the back of the instrument. The Control selection is for the RJ-45 10/100/1000Mbps Ethernet port.

Note: When changes are made to the control port IP address or the label of the instrument and NMOS is being used for configuration, we recommend rebooting the instrument to update the NMOS registration server.

Reset NMOS

To clear the NMOS configurations on the instrument: Select **Reset** and then select **Ok**. A loading icon appears as the configuration is loaded.

Note: Using RESET deletes the internal NMOS presets folder, removes any previous history of connections, and sets the NMOS configuration back to default values.

Configure Inputs with NMOS

As of version 4.3, enabling NMOS creates and registers six different devices. Each of these devices correlates to a PRISM virtual input.

The PRISM input associated with the device can be found in the device "label" and "instance-id" tag.

```
[
  {
    "id": "0d458ea0-9d1d-11ef-a193-00190f37cc5f",
    "label": "Input 1 on prism-mpi2-25_PQ300009",
    "description": "Telestream Prism Input 1 on prism-mpi2-25_PQ300009",
    "tags": {
      "urn:x-nmos:tag:asset:manufacturer/v1.0": [
        "Telestream"
      ],
      "urn:x-nmos:tag:asset:product/v1.0": [
        "PRISM"
      ],
      "urn:x-nmos:tag:asset:instance-id/v1.0": [
        "PQ300009-Input1"
      ],
      "urn:x-nmos:tag:asset:function/v1.0": [
        "2110 Input"
      ]
    }
  },
]
```

Each device contains the following NMOS receivers:

- 1 video receiver
- 8 audio receivers
- 4 ancillary data receivers

Each receiver indicates the PRISM input and stream number it configures in the "label", "description", and "grouphint".

```
{
  "id": "2c51cd58-9d28-11ef-b0f4-00190f37cc5f",
  "label": "Input 3 Audio Receiver 1 on prism-mpi2-25_PQ300009",
  "description": "Prism 2110-30/31 Audio Receiver number 1 for Input 3",
  "tags": {
    "urn:x-nmos:tag:grouphint/v1.0": [
      "Prism Input 3:Audio 1"
    ]
  },
  "format": "urn:x-nmos:format:audio",
  "caps": {
    "media_types": [
      "audio/L24",
      "audio/L32",
      "audio/AM824"
    ]
  },
  "subscription": {
    "sender_id": "3ace855e-4fc1-4bb2-870b-48131f79afd9",
    "active": true
  },
  "transport": "urn:x-nmos:transport:rtp",
  "interface_bindings": [
    "mmc0",
    "mmc1"
  ],
  "device_id": "2c4f5cda-9d28-11ef-b0f4-00190f37cc5f",
  "version": "1731348362:394856448"
},
```

Performing an NMOS activation on a receiver configures the stream(s) for the corresponding virtual input and media type. For instance, activating the above receiver will configure the Path 1 and 2 for Audio Stream 1 on the third input.

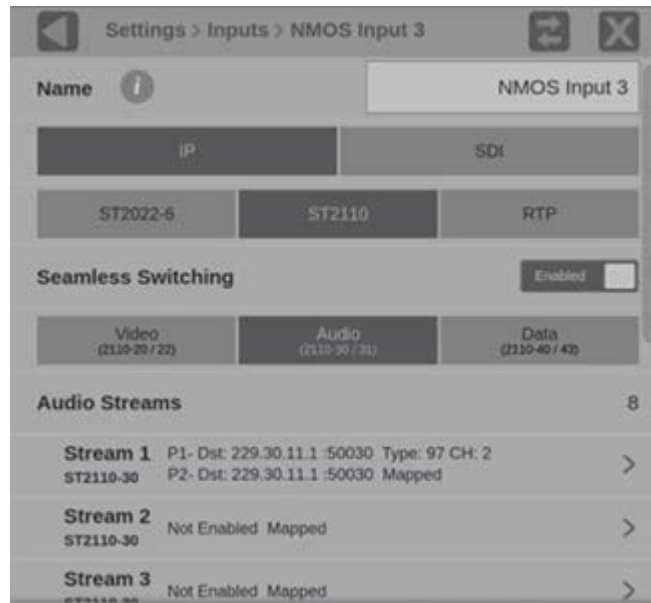

Note: NMOS activations will automatically set the corresponding input to IP, ST 2110, and rename to “NMOS Input <device number>”.

An NMOS activation will configure an input regardless of whether it is selected. An activation *will not* set the current/primary input.

To switch the current/primary input, use the ***activeInput*** PRISM API command.

Support for Existing Drivers

For custom NMOS drivers that expect PRISM to advertise a set number of devices and receivers, you can use the following PRISM APIs:

- **`nmos_single_device_mode`** – When this mode is enabled, PRISM only advertises a single NMOS device containing video, audio, and data receivers. Any receiver activations will configure the specified target input. When disabled, PRISM advertises six devices: one for each virtual input.
- **`nmos_target_input`** - Sets the target input for NMOS activations in single device mode. In this mode, any NMOS receiver activations will configure the specified input.
- **`nmos_audio_receivers_count`** – Sets the number of audio receivers each device advertises.
- **`nmos_anc_receivers_count`** – Sets the number of ancillary data receivers each device advertises.

Adjust Audio Settings

The Audio Settings menu has several tools that relate to aspects of the Audio application, the audio signal, and aural output. Details of several of these can be found in other parts of the document where they are specifically relevant.

1. Select the **Settings** icon ().
2. Select **Audio**.

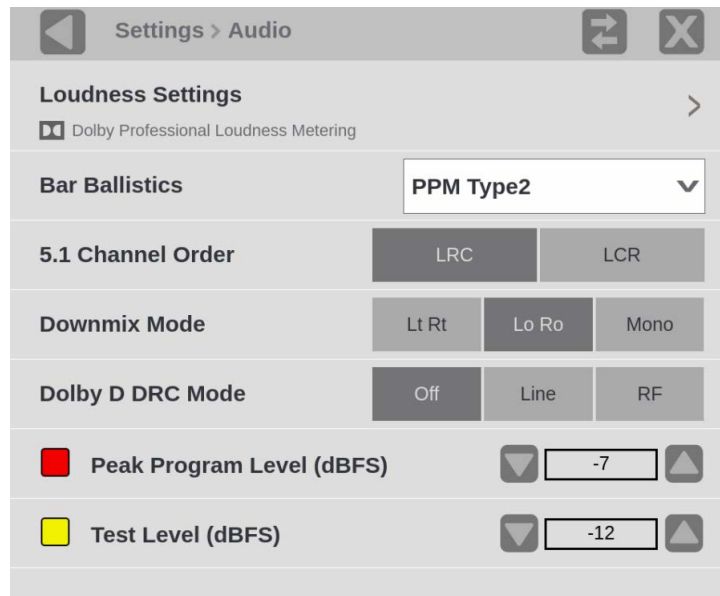

3. See the following sections for details about configuring these features:
 - Loudness Settings: see [Loudness Display](#).
 - Bar Ballistics: For details about ballistics options, see [Ballistics](#).
 - 5.1 Channel Order: For details about channel order options for 5.1 programs, see [5.1 Channel Order](#).
4. In the **Dolby DRC Mode** section, select **Off**, **Line**, or **RF**. Line and RF are modes of Dynamic Range Control (DRC)—compression—factors that are applied when decoding Dolby content for monitoring or output.

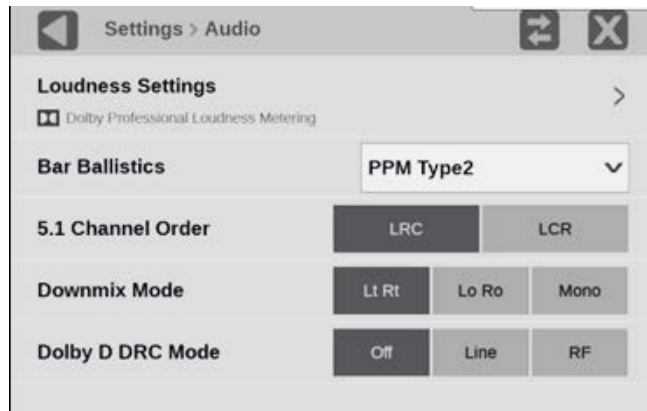

5. Select the **Downmix Dynamic Rng. : Line** or **RF**. These DRC compression factors are applied when downmixing to the various Dolby D listening modes.

Peak Program Level (dBFS)

This level is marked by the red arrow in the Audio application. Audio above this mark is shown in red. This audio is above the peak level.

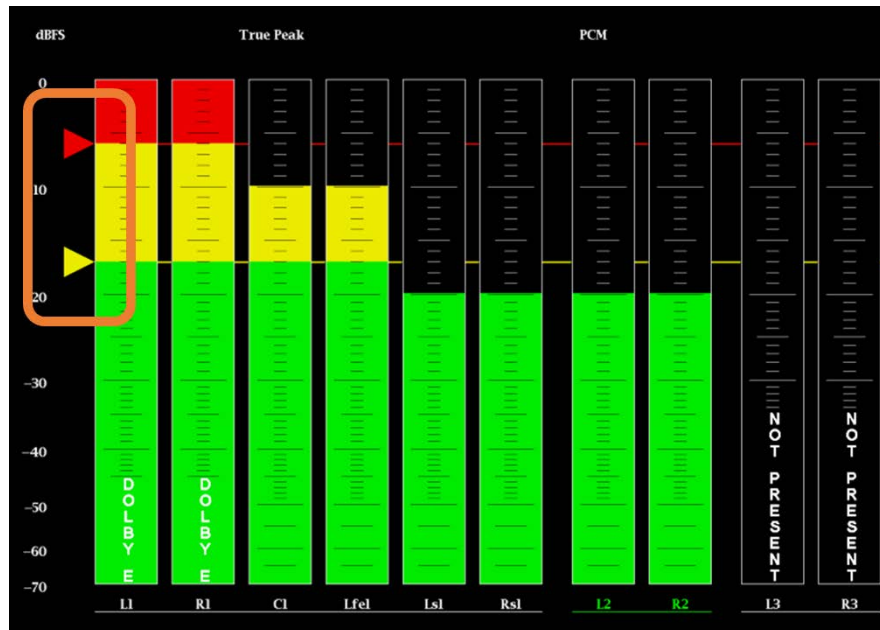

To change the Peak Program Level (dBFS) number:

1. In the **Audio** settings menu, select the **Peak Program Level (dBFS)** box.
2. Enter the number on the keypad or select the up or down arrows.



Test Level (dBFS)

Also called the reference or line-up level, the Test level is the yellow arrow in the Audio application. Audio above this mark is shown in yellow. This audio is between the test and peak levels.

To change the Test Level (dBFS) number:

1. In the **Audio Settings** menu, select the **Test Level (dBFS)** box.
2. Enter the number on the keypad or select the up or down arrows.

Note: The Test Level cannot be set above the Peak Program Level. If the peak is set to -5 then the test cannot be -4. If the test is set to -4 (through either the arrows or the keypad), the peak is automatically set to -4, also.

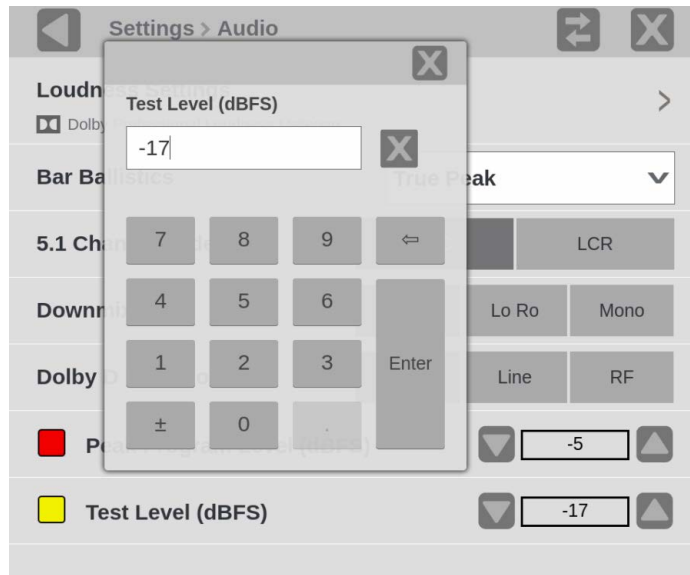

Configure Instrument Outputs

PRISM allows you to set the AUX OUT connector to Loop-through or Generator, and turn on the SDI loop-through. The AUX OUT connector always contains an SDI signal.

AUX OUTPUT 1/2

1. Select the **Settings** icon (⚙️) and select **Outputs**.
2. Set the **AUX OUTPUT** to one of the following:
 - **Loop-through:** The Loop-through option sends the active SDI or IP signal to the AUX OUT connector. If the active signal is IP, it is converted to an SDI signal at the AUX OUT connector. The MPP product also has dedicated loop-through connectors for each of the four SDI inputs. These dedicated loop-through connectors are always enabled.

Note: AUX OUT loop-through of IP inputs is available for SDI, ST 2022-6, and 2110-20/22/30/31 (see [Configure Audio \(2110-30/31\) Stream](#) for audio configuration details) including embedded audio streams.

- **Generator:** The Generator option sends the output of the SDI generator to the AUX OUT connector. See [SDI Generator Application](#) for instructions on how to configure the SDI Generator signal.

AUX OUT AUDIO CHANNELS

For ST 2110 Inputs, you can configure the aux out to remap the audio pair selected by the Headphone Pair to Aux Out pairs 1/2, regardless of their location in the Audio application.

1. Select the **Settings** icon (⚙️) and select **Outputs**.

2. Set the **AUX OUTPUT AUDIO CHANNELS** to **Selected headphone pair on Ch-1 and Ch-2**.
3. In the status bar, select **Volume**.
4. Select the pair from the list. All other audio pairs on the Aux Out are muted.

Note: In the case of multichannel audio, the Aux Out audio does not support remapping of downmixed audio, pair 1/2 is output instead.

Note: If the audio is decoded Dolby content, the volume pair selection is the raw pairs, with the exception that undecoded Dolby is not sent to the aux out to prevent speaker damage.

5. When **SDI LOOP-THROUGH** is set to **On**, SDI 1 is looped out to SDI 3 and SDI 2 is looped out to SDI 4.

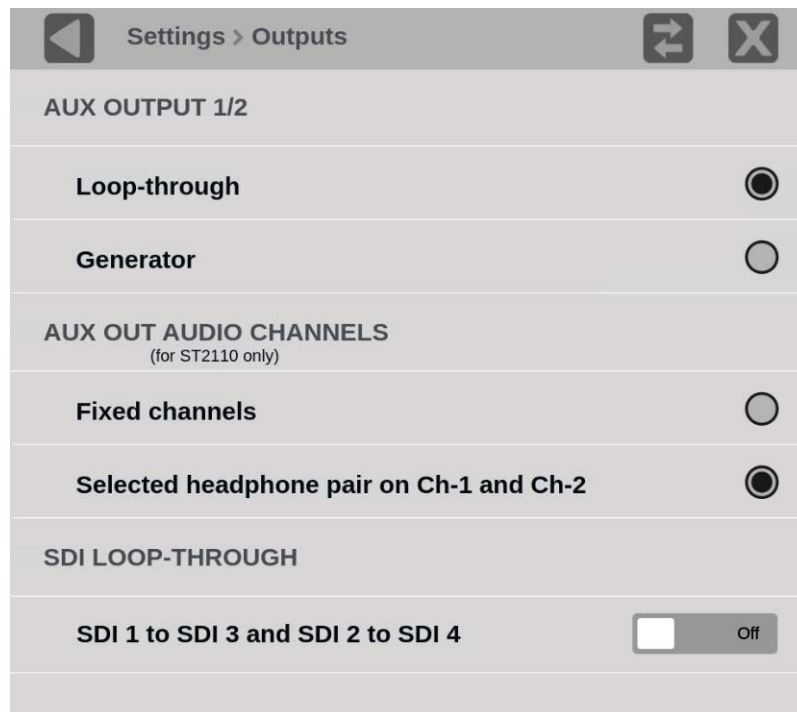

6. Close the Outputs menu.

Configure to Decode Timecode

Timecode decodes and displays ST 12-1:2014 Ancillary Timecode on the status bar. ANC LTC (linear time code), ANC VITC (vertical interval time code), and Date Readout are supported.

1. Select the **Settings** icon ().

2. Select **Anc Data**.

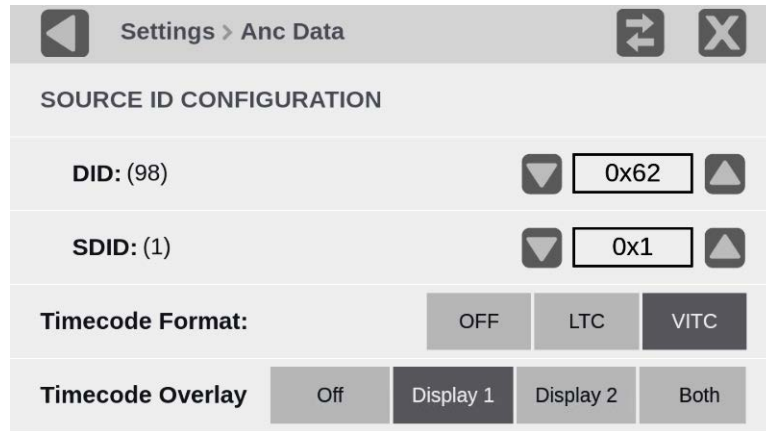

Select Timecode Format

In the **Timecode Format** section, select **LTC** or **VITC** as needed.

Note: Changing the timecode format changes the timecode at the bottom of the Status frame, all alarms and events, and in the timecode overlay.

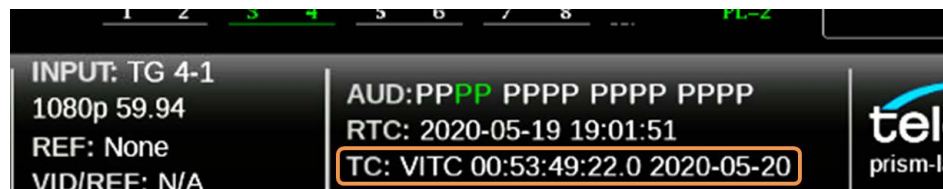

Turn on Timecode Overlay

In the **Timecode Overlay** section, select one of the following:

- **Off:** No timecode overlay is displayed.
- **Display 1:** Adds a timecode overlay to *only* the first monitor or screen.
Move the timecode: select it and drag it to any place in the first monitor or screen.
- **Display 2:** Adds a timecode overlay to *only* the second monitor or screen.
Move the timecode: select it and drag it to any place in the second monitor or screen.
- **Both:** Adds a timecode overlay to both monitors or screens (one on each).
Move each timecode independently: select one and drag it to any place in the respective monitor or screen.

Note: Both Timecode Overlays match the Timecode Format (LTC or VITC) in the Anc Data menu and the timecode in the Status frame.



Configure Reference Settings

The reference configuration of the PRISM is displayed in the middle of the status bar. The third line is the reference type and the fourth line displays the Video versus Reference lock indication. This indication shows if the signal is N/A, Mismatched, Drifting, or Locked.

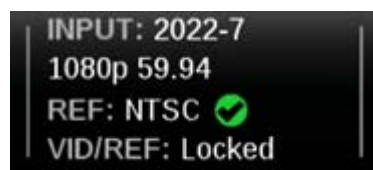

The Timing application supports SDI timing against Analog external reference, Analog external reference timing against PTP, SDI timing against PTP, and IP timing against PTP.

Choose External Reference

1. Select the **Settings** icon (⚙️).
2. Select **Reference**.



3. Select one of the reference options:
 - **Internal:** The timing is based on an internal clock.
 - **Analog:** Refers to a Black Burst or Tri-Level Sync (TLS) external reference. An analog external reference is connected to the REF BNC input on the back panel.
 - **PTP:** Refers to Precision Timing Protocol (PTP) external reference. PTP external reference must come through the 10/25GE SFP Port 1 input on the back panel.

Note: When you select a reference, the reference changes in the status bar and in the Timing application.

Configure Analog Reference Settings

1. Select the **Settings** icon (⚙️).
2. Select **Reference** and select the **Analog Ref Setting** tab.

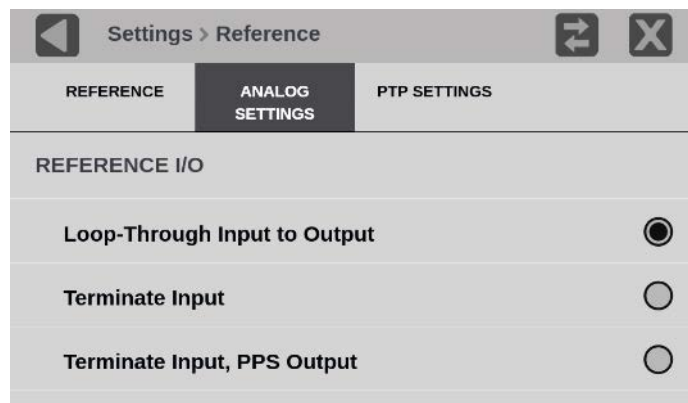

3. Select a reference I/O option:
 - **Loop-Through Input to Output:** The REF input is looped out the REF output BNC.
 - **Terminate Input:** The REF input is terminated at the REF input BNC. There is no signal at REF output BNC.

- **Terminate Input, PPS Output:** The REF input is terminated at the BNC. The REF output BNC will have the PPS signal when the PTP is locked.

Configure PTP Reference Settings

1. Select the **Settings** icon (⚙️).
2. Select **Reference** and select the **PTP Settings** tab.



3. Select **Enable PTP Logging to the Event Log** to enable or disable it.
4. Select the profile to configure: **ST2059**, **AES67**, or **General**. The default communication mode for each profile is Multicast.
 If you select the ST2059 profile and the communication mode, it is a mixture of Multicast and Unicast, select **Mixed SMPTE w/o negotiation**.

Note: On the SMPTE profile mixed mode, the PTP Announce and Sync messages are sent as Multicast. However, the Delay request and Delay Response messages are sent as Unicast.

5. Select the **Domain (0-127)** box.

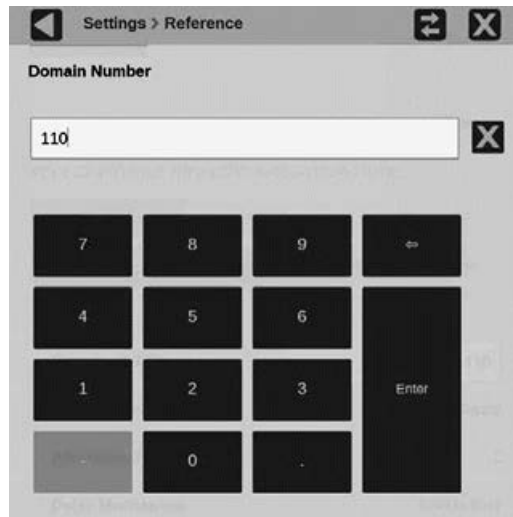

6. Use the editing controls to enter a new domain number. When using the editor:
 - Select the **Clear** icon (✕) to remove the existing domain number.
 - Tap **Backspace** to delete characters.
7. When you are done editing the domain number, press **Enter**.
8. Repeat Steps 4 through 7 for each PTP profile.

Configure and Recall Instrument Presets

Instrument setups can become complex as you tailor them to monitor various parameters. To save set up time and ensure consistency, you can save and quickly access instrument setups in your instrument using the **Presets** icon () on the instrument display.

Note: For the MPX2-25 monitor, you can recall instrument presets from the front panel. (See [Recall Instrument Presets.](#))

The instrument can store up to 36 separate instrument presets. The presets are divided into six groups, A through F, with each group containing 6 preset storage locations. The default preset names are A1-A6, B1-B6, C1-C6, D1-D6, E1-E6, and F1-F6.

All instrument settings except those set in the Utilities and Network Settings submenus of the Configuration menu are saved in a Preset. Settings that are not saved are those such as the clock setting, IP configuration, and network address. This is an overview of the settings saved in a Preset. Some settings are option dependent:

- Application assigned to each tile
- Application icon order in the application selector list
- Application specific settings
- Input selection and configuration (including single- and multi-input mode)

- PTP reference settings
- SDI Generator and IP Generator settings

Turn on Edit Mode

When Edit mode is on, selecting a preset button displays a menu to allow changes to that preset button (Rename and Save as) you can also recall the existing settings (Recall). You can assign any preset button with any configuration of applications, outputs, and inputs.



When edit mode is off, selecting a preset button only recalls the preset settings assigned to that button, with no confirmation.

To set Edit Mode on:

1. Select the **Settings** icon ().
2. Select **Presets**.
3. Set Edit Mode to **On**.

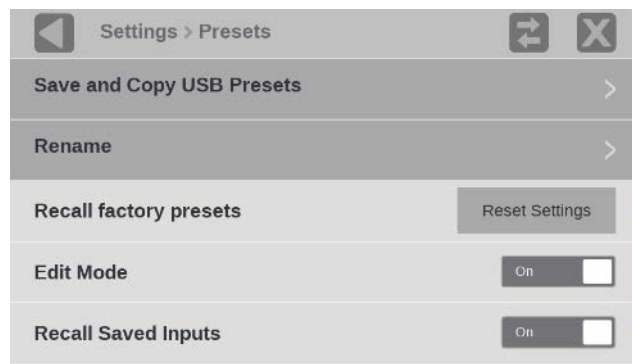

Save Presets

To save a preset with a user-defined name and settings, or to reassign a named preset with new name and settings:

1. Set up the instrument the way you want it configured. This includes selecting the application display for each tile and configuring inputs and the PTP reference settings.
2. *Turn on Edit Mode.*
3. Select the **Presets** icon (★) to open the Preset selection menu at the bottom of the PRISM display.

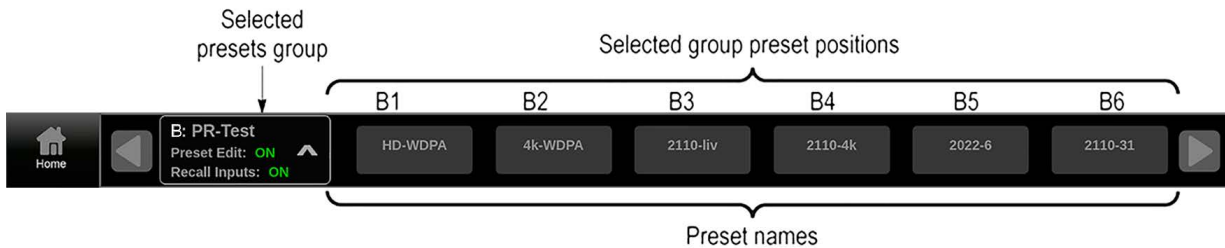

4. Locate the Preset button you want to save with the current instrument configuration. There are six presets in each of six groups. Use the arrow buttons (◀ and ▶) or swipe left or right to move to the preset group (A–F).

Note: When a preset has no content, <empty> is displayed on the preset button.

5. When you have found the preset to assign the settings (this includes choosing an assigned preset and overwriting the existing settings), select the preset button. A menu displays.



6. Select **Save As** to save the existing settings to the highlighted preset button and name it. An on-screen keyboard appears.
7. If the preset button name is <empty> or you want to change the name, use the keyboard. If you do not want to change the name, select **Save**. A confirmation window appears.
8. Select **OK** to save the preset. The preset name changes from <empty> or a name to the entered name. The number is the preset position in the preset group.
9. Select the **Home** icon (🏠) to close the Preset selection menu.

Rename PRISM Presets

To rename a preset without changing any settings.

1. [Turn on Edit Mode.](#)
2. Select the preset to rename.
3. Select **Rename** and use the keyboard to enter a new name. If Rename does not appear, Edit mode is not on.
4. Select **Save**.

Rename Group of Presets

1. Select the **Settings** icon ()
2. Select **Presets**.
3. Select **Rename**.



4. Select the **Preset** group, at the top of the submenu, to select the group with the preset to rename (this includes naming an <empty> preset).
5. Select the name box of the preset you want to name or rename. An on-screen keyboard appears.

Note: You can also rename a preset group by selecting a group name box.



6. Use the on-screen keyboard to enter a new name for the preset. When renaming a preset:
 - Enter a name with a maximum of 16 characters.
 - Select the **Clear** icon (X) to remove the existing name.
 - Tap **Shift** to access capital letters.
 - Tap **Backspace** to delete characters.
 - Tap the **123-abc** key to change between the letter keyboard and the numbers-symbols keyboard.
7. When the preset name is correct, select **Enter**.

Note: If the Edit Mode is on, you can rename a preset through the Preset selections menu. Select the preset to rename and then select **Rename**, and rename the preset just as in the Presets Rename submenu.

Download and Upload PRISM Presets

To download the presets of an entire PRISM (clone the presets) and upload them to another PRISM, there are two methods: [Download Presets to USB Drive](#) or [Download File of Presets Locally](#).

Download Presets to USB Drive

1. Insert a USB drive into the PRISM with the presets.
2. Select the **Settings** icon (⚙️).
3. Select **Presets**.
4. Select **Save and Copy USB Presets** and then select **SAVE TO USB**.
5. Select the USB drive and select **Save**.

A copy of the presets is downloaded to the USB drive.



6. Select the Activity icon (🔔) and then select the **Eject** icon (🗑️) to unmount the USB drive from the instrument.
7. Remove the USB drive with the presets from the PRISM.
8. To upload the presets to another PRISM, go to [Upload Presets from USB Drive](#).

Upload Presets from USB Drive



CAUTION: Uploading presets overwrites all existing presets in the PRISM.

1. Insert a USB drive with PRISM presets into the PRISM to upload the presets.
2. Select the **Settings** icon (⚙️).
3. Select **Presets**.
4. Select **Save and Copy USB Presets** and then select **COPY FROM USB**.
5. Select the USB memory drive and select **Copy**.

The downloaded presets are uploaded to the PRISM.



6. Select the Activity icon (🔔) and then select the **Eject** icon (🗑️) to unmount the USB drive from the instrument.
7. Remove the USB drive with the presets from the PRISM.
8. Select the **Close** icon (✕) to close the Save and Copy USB Presets submenu.
9. Repeat steps 1 to 9 for any other PRISMs to copy the presets.

Download File of Presets Locally

1. Use a web browser to access the PRISM HOME page for the PRISM with the presets.

2. Select **Preset Download and Upload**. (Some home pages have different options than the example.)

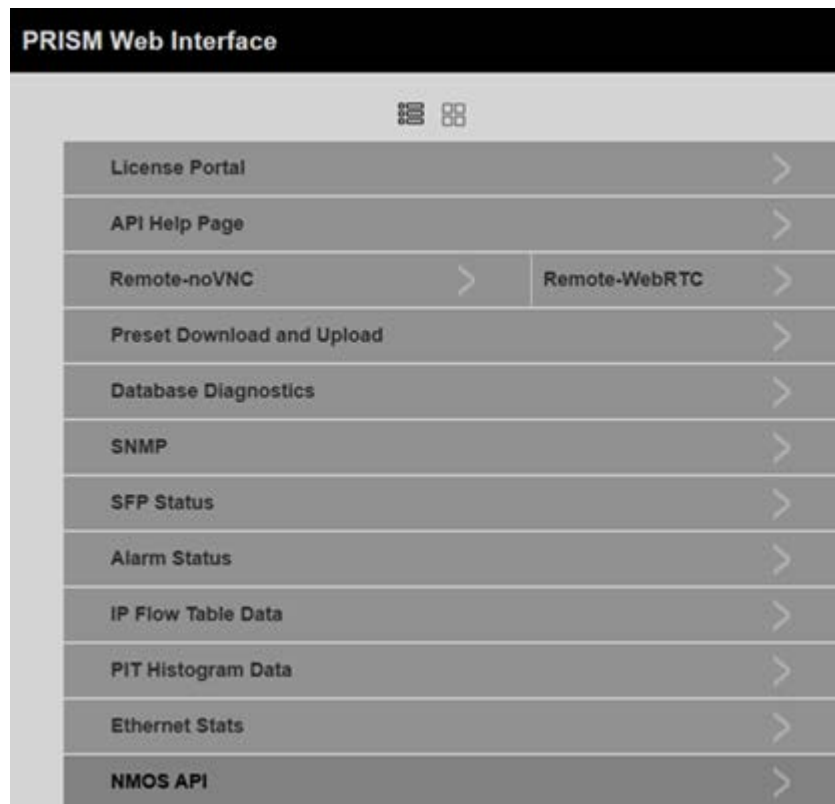

3. Select **Download from PRISM** and then select **Download**.
A copy of the presets is downloaded to the local computer with the name of the PRISM and a timestamp, or you can rename the presets file.
4. To upload the presets to another PRISM, go to [Upload Presets through PRISM Homepage](#).



Upload Presets through PRISM Homepage

 **CAUTION: Uploading presets overwrites all existing presets in the PRISM uploading the presets.**

1. With the presets file downloaded locally, go to the PRISM HOME page for the PRISM to upload the presets.
2. Select **Preset Download and Upload**.

3. Select **Upload to PRISM** and then select **Browse**. A file explorer window displays.



4. Find the saved preset (.prst) file, select it, and select **Open**. The file explorer window closes and the preset file is listed on the PRISM HOME page.

5. Select **Upload**. The downloaded presets are uploaded to the PRISM.



6. Repeat steps 1 through 5 for any other PRISMs to receive the same presets.

7. Select the browser back button to return to the PRISM HOME page.

Recall User-Defined Presets

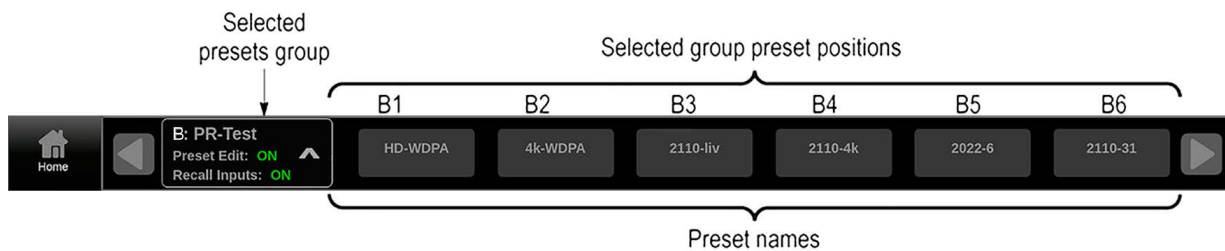
1. Select the **Presets** icon () to open the Preset selection menu.



2. Find the preset to recall. Use the arrow buttons ( and ) or swipe left or right to move to the preset group (A–F).

Note: When a preset has no content, <empty> is displayed on the preset button.

3. Select the preset button to recall. The selected preset button is highlighted and the instrument settings change to those assigned to the selected preset.

4. Select the **Home** icon () to close the Preset selection menu.

Note: If the Edit Mode is on, select the preset to recall and then select **Recall** from the menu.

Use Preset Menu Options

This menu has several options instead of using the Settings menu:

1. Select the **Preset** menu button.

- Turn the **Preset Edit Mode** on or off; set the option to **On** or **Off** as needed.
- Turn the **Recall Saved Inputs** on or off; set the option to **On** or **Off** as needed.

For details about the Recall Saved Inputs option, see [Recall Presets without Inputs](#).

- Rename the preset group:
 - i. Select **Rename Preset Group**. To change individual preset names, see An on-screen keyboard appears.
 - ii. Rename the current group name with the on-screen keyboard or a physical keyboard.
 - iii. Select **Save** to save the new name or close the window to cancel the change.



2. Select the **Preset** menu button a second time to close the menu.

Recall Presets without Inputs

Presets contain all PRISM settings including input configuration. Turning off the Recall Saved Inputs setting allows the presets to be recalled without recalling any of the input settings (video, audio, data). In this mode only the application and other settings are recalled.

Note: The preset still has all of the input settings, they are just not applied when the Recalled Saved Inputs setting is off.

1. Select the **Settings** icon (⚙️).
2. Select **Presets**.
3. Set **Recall Saved Inputs** to **Off**.

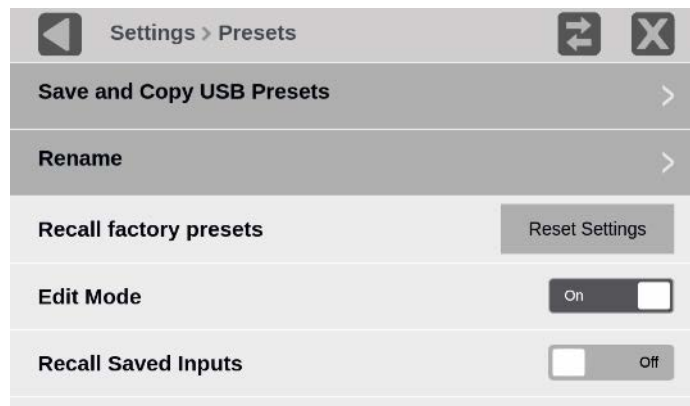

Recall Factory Presets

1. Select the **Settings** icon ().
2. Select **Presets**.
3. Select **Reset Settings**. A confirmation box opens.

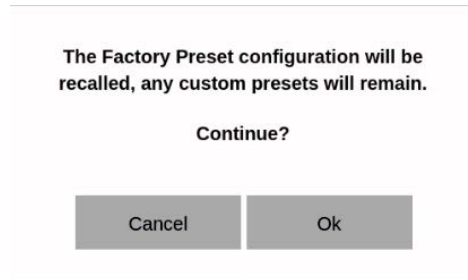

4. Select **OK** to confirm the selection and to reset the instrument settings to the factory defaults. The next table lists some of the settings that are reset.

Note: Custom presets are still available after recalling the factory preset.

Instrument settings reset by Recall factory preset

Item	Setting
Tile 1 application	Waveform
Tile 2 application	Video Session
Tile 3 application	Picture
Tile 4 application	Audio
SDI-In 1 input configuration	
Input name	SDI-In 1
Input type	SDI
Input connector	SDI 1
SDI-In 2 input configuration	
Input name	SDI-In 2
Input type	SDI
Input connector	SDI 2
SDI-In 3 input configuration	
Input name	SDI-In 3
Input type	SDI
Input connector	SDI 3

Instrument settings reset by Recall factory preset

Item	Setting
SDI-In 4 input configuration	
Input name	SDI-In 4
Input type	SDI
Input connector	SDI 4
SDI-In 5 input configuration	
Input name	SDI-In 5
Input type	SDI
Input connector	SDI 1
SDI-In 6 input configuration	
Input name	SDI-In 6
Input type	SDI
Input connector	SDI 2
PTP reference configuration	
PTP Logging to the Event Log	Enabled
Selected Profile	ST 2059
ST 2059 domain	127
ST 2059 communication mode	Multicast
SDI Generator configuration	
Enable SDI Generator	Disabled
IP Generator configuration	
Enable IP ST 2110 Generator	Disabled
Reference	Internal

Set Syslog Setup

Note: PRISM supports Syslog protocol (RFC 5424) for alarms and events.

1. Select the **Settings** icon (⚙️).
2. Select **Network** and then select **REMOTE ACCESS**.

STATUS	CONTROL IP PORT	VIDEO IP PORT	REMOTE ACCESS	NMOS
Hostname		mpi2-25		
Password		PRISM		
SYSLOG SETUP				
Syslog Server Address		10.101.3.116		
Syslog Server Port		514		
Syslog Set		Clear	Save	

3. Fill in Syslog Server Address with the IP address of the computer running the syslog server software.
4. Fill in Syslog Server Port with the number configured in the syslog server software.

Note: For questions on configuring your syslog server software, contact your system administrator.

5. Select **Save**.

The syslog server software collects events and alarms, and displays the details.

Date	Time	Priority	Hostname	Message
03-12-2021	17:01:49	User.Info	10.101.3.118	Mar 12 16:52:27 mpi2-25-mastercontrol Prism[2228]: Audio Pair Out Of Phase :: Clear at time 2021-03-13 00:52:27 timecode 01:00:29:27 (LTC)
03-12-2021	17:01:48	User.Info	10.101.3.118	Mar 12 16:52:26 mpi2-25-mastercontrol Prism[2228]: Video signal lost :: Clear at time 2021-03-13 00:52:27 timecode 01:00:29:11 (LTC)
03-12-2021	17:01:48	User.Error	10.101.3.118	Mar 12 16:52:26 mpi2-25-mastercontrol Prism[2228]: Video signal lost :: Set at time 2021-03-13 00:52:27 timecode 01:00:29:11 (LTC)
03-12-2021	17:01:48	User.Error	10.101.3.118	Mar 12 16:52:26 mpi2-25-mastercontrol Prism[2228]: Audio Pair Out Of Phase :: Set at time 2021-03-13 00:52:26 timecode 01:00:28:29 (LTC)
03-12-2021	17:01:48	User.Info	10.101.3.118	Mar 12 16:52:26 mpi2-25-mastercontrol Prism[2228]: Audio Signal Lost :: Clear at time 2021-03-13 00:52:26 timecode 01:00:28:28 (LTC)

SNMP Functionality

This section explains how to use and set the SNMP controls and traps (alarms).

SNMP Web UI Controls

This section explains how to configure SNMP through a web browser.

1. Go to the PRISM homepage (enter the PRISM IP address in a web browser).
2. Select **SNMP** and set the Enable SNMP Traps to **Enable**.
3. Fill in the **Trap Destination** and **Trap Community String** fields.
4. Select **Download** to download the SNMP MIB.

SNMP Traps

PRISM supports SNMP only for alarms (traps). PRISM supports a single trap prefix (prismTrap), which can be seen in the Video signal lost sample. The SNMP configuration is created through the RESTful API.

- The alarm is identified in the SNMP trap payload.
- The PRISM SNMP MIB is provided in the file prism_mon.mib file, which can be downloaded from the PRISM web page.
- SNMP trap destination address is set with RESTful API using post operation, through Postman or a similar application.
- The alarms generated in the PRISM are sent to the destination trap receiver as a single SNMP trap.
- Users must have a trap receiver running on the destination machine and the IP address of the PRISM (snmpAgent) need to be configured with the destination IP address.

Enable Restful API SNMP Controls

Note: To open the PRISM help page, go to <http://IpAddress/api/help> (replace "IpAddress" with your PRISM IP address).

Note: To set the SNMP_TRAP_ENABLE_ON you need an API development application, such as Postman.

1. In a PRISM open an API development application, such as Postman.
 - GET and POST are allowed commands.
 - In these examples, replace "aaa.aaa.aaa.aaa" with the IP address of the PRISM the sending the traps and "bbb.bbb.bbb.bbb" with the IP address of the computer receiving the traps.
2. Set the SNMP_TRAP_ENABLE_ON:
 - A. Enter the IP address of the unit:

```
aaa.aaa.aaa.aaa/api/snmp_trap_enable
```
 - B. In the body of the JSON command, enter:

```
{  
  "ints": [  
    "SNMP_TRAP_ENABLE_ON"  
  ]  
}
```
 - C. Execute as a POST operation.

3. Set the trap destination address:
 - A. Enter the following command:
aaa.aaa.aaa.aaa/api/snmp_trap_destination_address
 - B. In the body of the JSON command, enter:

```
{
            "string": "bbb.bbb.bbb.bbb"
          }
```
 - C. Execute as a POST operation.
4. Set the SNMP community string:
 - A. Enter the address of the unit:
aaa.aaa.aaa.aaa/api/snmp_trap_community
 - B. In the body of the JSON command, enter:

```
{
            "string":
            "new_trap_community"
          }
```
 - C. Execute as a POST operation.

Check the Traps

1. Download prism_mon.mib from the PRISM web page.
 - A. Open the PRISM instrument home page.
 - B. Enter the PRISM IP address in a browser.
 - C. Select **SNMP** in the PRISM menu.
 - D. Select **Download**.

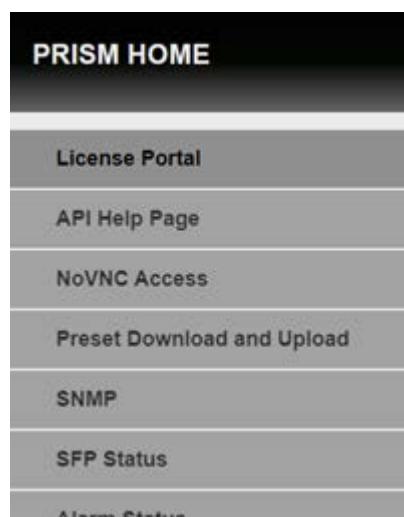

2. Install any SNMP manager on the machine where you want to check the traps.

- A. From the SNMP manager, configure the SNMP agent (PRISM) IP address.
- B. Load the prism.mib file.
- C. Open the trap receiver window.
- D. Confirm the traps are received on the trap receiver window of the MIB browser application on the destination machine (on port 162).



Alarms

Alarms are always operational and logged (with a few exceptions). They are also optionally sent to a syslog server or SNMP client. For each alarm group or individual alarm, you can also enable presentation on the Activity Dashboard.

Many alarms also have user-definable thresholds to set specific limits for the alarm.

Configure Alarms

Select the **Settings** icon (⚙️) and then select **Alarms**.

- To turn on the group of alarms, select the checkbox under Dashboard for the group.
- To reset the thresholds for a group of alarms, select the reset icon (🔄) under Threshold for the group.

	Threshold	Dashboard
ANC Session	🔄	☑️
Audio	🔄	☑️
CC / Subtitles	🔄	☑️
Gamut	🔄	☑️
HDR	🔄	☑️
IP	🔄	☑️
Timing	🔄	☑️
Video Session	🔄	☑️

Select Specific Alarm

1. Select the **Settings** icon (⚙️), select **Alarms**, and then select the alarm group that contains the specific alarm.
2. Select the UI checkbox of the alarm to monitor.

Alarm	Threshold	Dashboard
Audio Over Error	>0 dB for >1 s	<input checked="" type="checkbox"/>
Audio Pair Out of Phase	<-30% for >1 s	<input type="checkbox"/>
Audio Signal Lost	N/A	<input type="checkbox"/>

Change Alarm Threshold

Note: If the alarm shows information in the Threshold column (not N/A), you can change the setting.

1. Select the alarm title.
The Thresholds option displays.
2. Select the arrows to change the threshold settings.

Depending on the alarm selected, there could be from one to four thresholds.

Alarm	Threshold	Dashboard
Audio Over Error	>-2 dB for >1 s	<input checked="" type="checkbox"/>
Duration <input type="text" value="1"/> s		
Max <input type="text" value="-2"/> dB		
Audio Pair Out of Phase	<-30% for >1 s	<input checked="" type="checkbox"/>
Audio Signal Lost	N/A	<input checked="" type="checkbox"/>

All Alarms

This lists all the available alarms by group with the individual alarm titles in bold. And there are descriptions of each alarm and what parts of alarms can be set, if any.

ANC Session

Duplicate SCTE104 Message: A copy of an SCTE104 packet has been received as seen on the ANC Session application.

SCTE104 Message: An SCTE104 packet has been received as seen on the ANC Session application.

Audio

- **Audio Over Error:** Audio signal is at or above the specified Max audio level for a time longer than the Duration setting. Duration and the Max decibels of the audio can be set.
- **Audio Pair Out of Phase:** Currently selected channels displayed in Lissajous have the channel correlation at or below the specified percentage for a time longer than the duration setting. Duration and the Min percentage of the audio pair phase can be set. See [Audio Pair Out of Phase Alarm Description](#).
- **Audio Sample Peak:** Max dBFS can be set.
- **Audio Signal Lost:** No Audio is present in the currently active signal.
- **Audio Silence Error:** Duration in seconds and Min dB can be set.
- **Audio True Peak:** Max dBTP can be set.
- **Loudness Dialogue Meas:** Max dialnorm can be set.
- **Loudness Infinite:** Max and Min LKFS/LUFS can be set.
- **Loudness Momentary:** Max LKFS/LUFS can be set.
- **Loudness Range:** Min LU can be set.
- **Loudness Short:** Max LKFS/LUFS can be set.
- **Loudness Speech:** Min % can be set.

CC (Closed Captions) / Subtitles

- **ARIB Closed Captions Lost:** No valid ARIB closed caption packets in the ancillary data space were found. Duration of the loss can be set.
- **CEA708 Closed Captions Lost:** No valid CEA708 closed caption packets in the ancillary data space were found. Duration of the loss can be set.
- **OP-47 Multipacket Teletext Lost:** No valid Operational Practice 47 multi data packets were found in the ancillary data space of the signal. Duration of the loss can be set.
- **OP-47 SDP Teletext Lost:** No valid Operational Practice 47 SDP data packets were found in the ancillary data space of the signal. Duration of the loss can be set.

- **S334-1 CEA608 Closed Captions Lost:** No valid ST 334-1 CEA 608 closed caption packets were found in the ancillary data space. Duration of the loss can be set.
- **S334-2 CEA608 Closed Captions Lost:** No valid ST 334-2 CEA 608 closed caption packets were found in the ancillary data space. Duration of the loss can be set.
- **SMPTE 2031 Teletext Lost:** No valid ST 2031 ANC data packets were found in the ancillary data space. Duration of the loss can be set.

Gamut

- Input signal contains colors that violate the set limits for YRGB gamut thresholds. Set limits: YRGB minimum and maximum, Picture Area percent, and Frame Duration. See [Gamut Alarm](#).

HDR

Note: If you are using an MPI or MPX (not an MPI2 or MPX2) that is upgraded with a -25 multimedia board, the HDR alarms are not supported. The HDR alarms are visible in the alarms list and you can adjust the HDR alarm settings, but no HDR alarm are generated or logged.

Note: These errors relate to the information displayed in the Measurement Overlay. See [Measurement Overlay: Details](#).

To turn on the HDR alarms, in Settings () in Alarms, set Enable HDR Alarms to **On**.

- **Area HDR Percent:** Area of the video image that is in the HDR Zone (above HDR Zone Threshold Nits). This is the value reported by the “% HDR Area” in the Picture Measurements overlay.
- To set the HDR Zone Threshold, go to the Measurement Thresholds in Picture Settings.
- **Area Percent Nits:** Percent of the area of the active video that is above the specified threshold (in nits) for more than the specified duration.
- To set the Area (%), go to the Measurement Thresholds in Picture settings.
- **Brightest Percent Nits:** Brightest percent of the active video that is above the specified threshold (in nits) for more than the specified duration.
- To set the Brightest Area (%), go to the Measurement Thresholds in Picture settings.
- **Contrast Ratio:** Contrast ratio of the video is above or below the specified thresholds for more than the specified duration.
- **Darkest Percent Nits:** Darkest percent of the active video is above the specified threshold (in nits) for more than the specified duration.
To set the Darkest Area (%), go to the Measurement Thresholds in Picture settings.
- **Dynamic Range:** Dynamic range of the video is above or below the specified thresholds for more than the specified duration.

IP

- **Combined RTP Sequence Error:** RTP sequence error occurred in the combined output of a media stream protected using RTP packet reordering or ST 2022.7 seamless switching.
- **Data Rate Invalid or Unstable:** Detected data rate of a video input is unstable or nonstandard.
- **Ethernet BER Excessive:** Excessive bit-error rate has been detected on Ethernet interface.
- **Ethernet Buffer Overflow:** Overflow was detected on IP Video Ports.
- **Ethernet CRC Error:** CRC error was detected in an Ethernet frame.
- **Ethernet Interface Saturated:** Ethernet interface is saturated.
- **HBRMT Header Invalid:** Error occurred in the HBRMT header.
- **HBRMT Sequence Error:** Packets are dropped, out of order, or duplicated; or a sequence number in a flow does not change.
- **HBRMT Timestamp Error:** HBRMT timestamp is corrupt or is not updating at the correct frequency for the specified media type.
- **L4 Protocol Checksum Error:** Checksum error was detected in an IP or UDP packet.
- **Network Connection Lost:** Fiber connection to SFP port has been removed or FEC mode is in the wrong state.
- **RTP Header Invalid:** Error occurred in the RTP header.
- **RTP Marker Frequency Error:** RTP marker bit is not designated at the correct frequency for the specified media type.
- **RTP Sequence Error:** Sequence errors can be caused by dropped, out of order, or duplicated packets. They can also be triggered when the sequence number within a flow does not change.
- **RTP Timestamp Error:** RTP timestamp is corrupt or is not updating at the correct frequency for the specified media type.
- **S2022.7 Path Missing:** One of the data paths in a ST 2022-7 seamless switching configuration is missing.

Timing

- **External Reference Lost:** External reference signal is not detected.
- **Link Timing Error:** Timing difference between any two links exceeds 400 nanoseconds, according to ST 425-6 2014.
- **PTP Unlocked:** PTP is unlocked or missing.
- **Timing Drift:** Input signal is not frequency locked to the reference signal. Drift rate is more than 10 us of timing change on a 20-second window, larger drift rates are detected faster.

- **Video and Reference Mismatch:** Detected format of the external reference signal is not compatible with the input signal format.

Video Session

- **Format Unsupported:** Detected video format is not supported.
- **Inter-link Format Mismatch:** Four links of a quad-link signal are not the same format.
- **SD Video Detected:** Detected video format is standard definition, for example 525 or 625.
- **SDI Active Field Length Error:** Input signal is not frequency locked to the reference signal
- **SDI C-channel ANC Checksum Error:** Displays the status of the C channel ancillary embedded checksum value that was calculated for the video signal. Using a known test signal, the checksum status can be used to verify integrity through a system. An error means that the C Channel embedded checksum value does not match the calculated checksum value, which indicates that a transmission error has occurred.
- **SDI C-channel CRC Error:** Displays the status of the C channel embedded CRC (Cyclical Redundancy Check) that was calculated for the video signal. Using a known test signal, the CRC status can be used to verify integrity through a system. An error means that the C Channel embedded CRC value does not match the calculated CRC value, which indicates that a transmission error has occurred.
- **SDI EAV Placement Error:** SDI End-of-Active Video placement error has occurred.
- **SDI EDH Active Picture CRC Error:** RP165 AP CRC value embedded in the data stream differs from the calculated CRC, or that it has been marked as invalid in the EDH packet, indicating there are EDH errors in the active picture.
- **SDI EDH Full-Field CRC Error:** RP165 FF CRC embedded value differs from the calculated CRC value (or that it has been marked as invalid in the EDH packet), indicating that there are EDH errors in the full field.
- **SDI Line Length Error:** Incorrect encoded transport line number was detected.
- **SDI Line Number Error:** Incorrect encoded transport line number was detected.
- **SDI SAV Placement Error:** SDI Start-of-Active Video placement error has occurred.
- **SDI Total Field Length Error:** The total field length of SDI video is incorrect.
- **SDI Y-channel ANC Checksum Error:** Displays the status of the Y channel ancillary embedded checksum value that was calculated for the video signal. Using a known test signal, the checksum status can be used to verify integrity through a system. An error means that the Y Channel embedded checksum value does not match the calculated checksum value, which indicates that a transmission error has occurred.
- **SDI Y-channel CRC Error:** Displays the status of the Y channel embedded CRC (Cyclical Redundancy Check) that was calculated for the video signal. Using a known test signal, the CRC status can be used to verify integrity through a system. An error means that the Y Channel embedded CRC value does not match the calculated CRC value, which indicates that a transmission error has occurred.

- **SMPTE 352M Payload ID Missing:** A mandatory ST 352M video payload identifier packet is missing.
 - **Video Format Changed:** TRS count performed by the instrument does not agree with the line number embedded in the 292M line.
 - **Video Format Mismatch:** Detected format of the video-input signal does not match the Input Format setting (which is set to a specific line rate, rather than being set to Auto) in the SDI Input submenu of the Configure menu or the setting specified in the ST 352 payload (if present).
- Video Signal Lost:** Video input signal has not been detected at the selected input.

Alarm Descriptions

This section has more details about certain alarms.

Audio Pair Out of Phase Alarm Description

The Audio Pair Out of Phase alarm warns if the audio signals in a pair are out of phase, according to set duration and percentage of phase.

The example alarm is set for 1 second duration of -30%.

Alarm	Threshold	Dashboard
Audio Over Error	>-2 dB for >1 s	<input checked="" type="checkbox"/>
Audio Pair Out of Phase	<-30% for >1 s	<input checked="" type="checkbox"/>
Duration	<input type="text" value="1"/> s	
Min	<input type="text" value="-30"/> %	
Audio Signal Lost	N/A	<input checked="" type="checkbox"/>

The percentage describes the location on the correlation meter (below the Lissajous image) in the Audio application. So long as the phase marker (green diamond) does not drop below -30% (in the example setting) for more than a second, the alarm will not occur.

Note: The midpoint of the correlation meter is 0. Far left is -1 or -100%, which is out of phase. Far right is +1 or +100%, which is in phase.

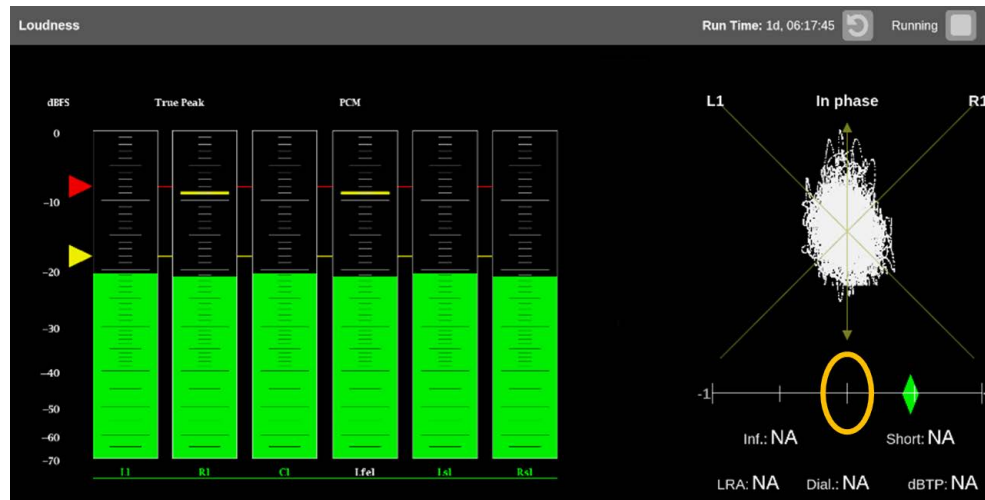

Gamut Alarm

The gamut alarm indicates when the input signal contains colors that violate the currently set limits for YRGB gamut thresholds, which are specified by the Settings/Alarms/Gamut. These measurements conform to the EBU R103 V3 standard.

- **Enable Gamut Alarm:** Set to **Off** to disable gamut measurements and minimize CPU loading for quieter operation.
- **Gamut Preset:** Select **EBU R103** to reset the gamut measurements to the EBU R103 V3 defaults. The Gamut Preset resets only the YRGB thresholds, not the Picture Area or Frame Duration.
- Thresholds can be displayed in either 10-bit or 12-bit representation.
- **YRGB:** Select the line to set Min and Max.
- **Picture Area:** Select anywhere in the line to open the control to set a percentage.
- **Frame Duration:** Select anywhere in the line to open the control to set the number of frames.



Gamut alarms are reported in the Event Log application in the format:

- **Gamut Violation:** Max YRGB, Min yrgb, Area xx.x%
 - Max YRGB: violation for Y, R, G, or B components, violations are marked by an uppercase component letter. Underscores are used when no violations are found.
 - Min yrgb: violation for Y, R, G, or B components, violations are marked by a lowercase component letter. Underscores are used when no violations are found.
 - Area: the percent of the active picture that is in violation for one component. This is only the component with the most violation, not all components together.
- **Limits:** Max xxxd, Min xxxd, >x% Area, >X Frames
 - These limits were in effect when the alarm was asserted.

In this example:

- Max has violations in G and B. Min has violations in the y, r, g, and b components. The component with the most violation covers 0.9% of the active picture.
- Gamut Maximum is set to 984d, the Minimum Threshold is set to 20d, the Picture Area is set to 1 percent, and the Frames Duration is set to 1.

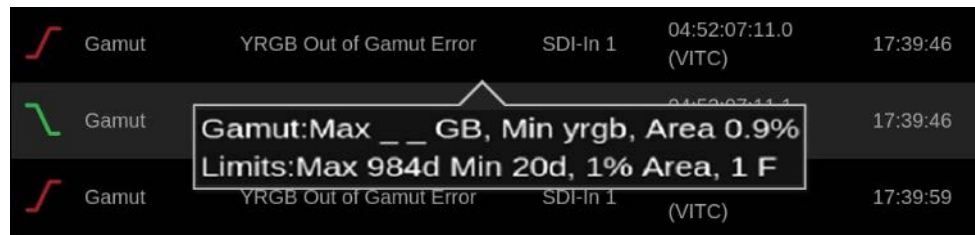

Note: When Gamut is disabled, no Gamut alarms are generated or logged.

Gamut measurements are not supported for psF, 3G Level-B, SQD, or 8K input signals.

Adjust Display

The display has settings for screen labels when multi input is used and settings for trace and graticule intensity. It also has controls for extended display, which are explained in the [Display Operation](#) section of the manual.

Set Source Label

When you use multi-input, you can define where and how the on-screen labels appear:

1. Select the **Settings** icon ().
2. Select **Display**.

3. Select **MULTI INPUT**.



Note: You can set these options when multi-input is on or off.

Source Label Position

The on-screen, multi-input label is visible when Multi Input is on. To change the location of the label:

- on the Multi Input page, select the **Source Label Position** menu and choose the location of the display; or
- in a tile, select a label and drag it to one of the four corners of the tile. The other labels in the other tiles will change to match.

Source Label Timeout

You can configure whether labels are displayed as well as how long they are displayed. To change the action of the labels, select the **Source Label Timeout** menu and select from the options. These settings affect all tile labels.

Configure Safe Area Graticules

When you use safe-area graticules, you can define where and how the Picture application on-screen graticules appear.

1. Select the **Settings** icon ().
2. Select **Display**.
3. Select **SAFE AREA GRATICULES**.

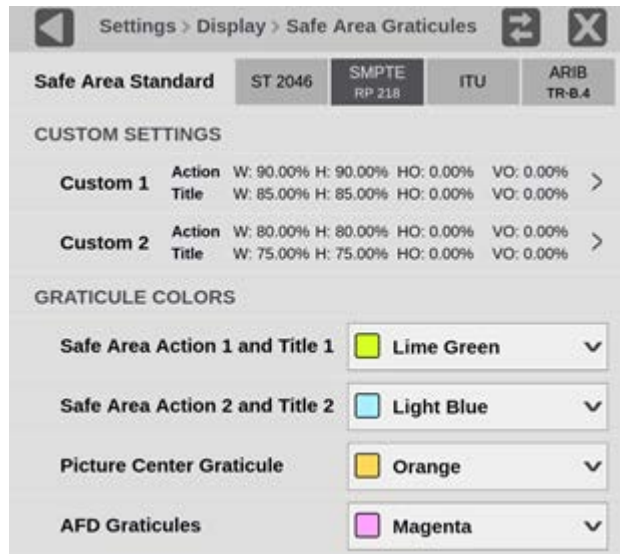

4. In the **Safe Area Standard** section, select a standard: **ST 2046**, **RP 218**, **ITU**, or **ARIB TR-B.4**. The safe areas must be turned on in a Picture tile to appear. For details about turning on the selected safe areas, see [Select Safe Area Graticules](#).
5. To set custom safe areas:
 - A. Select anywhere in **Custom 1** or **Custom 2**.

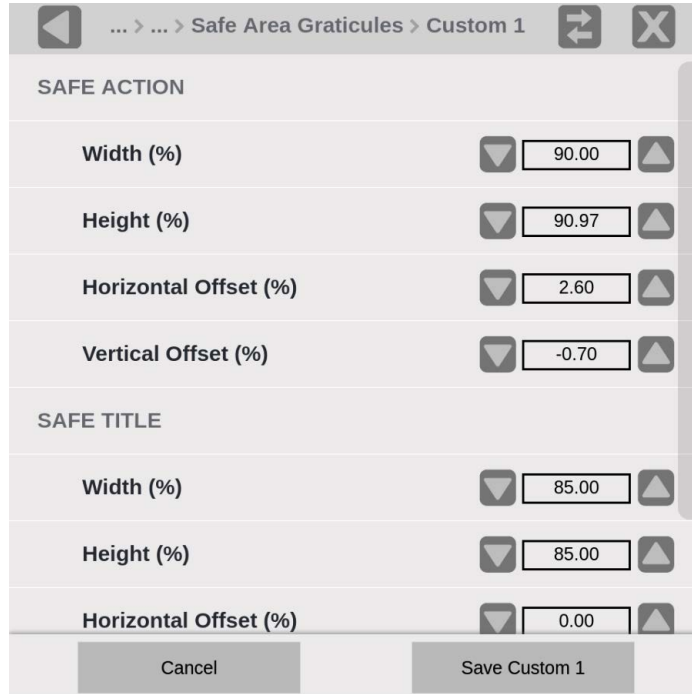

B. Update the **Width** and **Height** settings as needed.

- ◆ In the **Width** and **Height** boxes, type a percent number up to the hundredths place; or
- ◆ Select the up or down arrows to set the numbers. The arrows change the number by hundredths. Hold the arrow to change the number faster.

Note: The percent number is the percent of the image (active height or width) the custom frame will surround.



The SAFE ACTION frame turns on a solid line in the Picture tile.
The SAFE TITLE frame turns on a dashed line in the Picture tile.

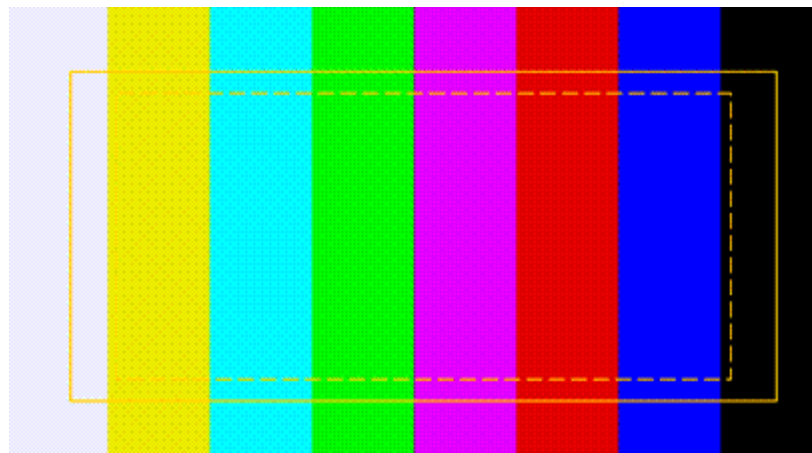

Note: Because the safe area is defined by percent of the image, the image format does not affect the marked area. For example, 90% of the height of the image is 90% for 1280 x 720 or 4096x2160.

- C. If you need to move the frame off-center, select in the **Horizontal Offset** or **Vertical Offset** box and enter the percent of the frame to move the safe area.
- ◆ Select the \pm symbol in the on-screen keypad to switch between positive and negative numbers.
 - ◆ To move the frame horizontally, positive numbers move the frame to the right, negative numbers move the frame to the left.
 - ◆ To move the frame vertically, positive numbers move the frame down, negative numbers move the frame up.

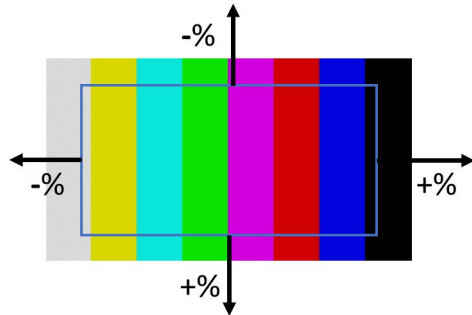

If the Offset takes a graticule frame outside the Picture tile, the border (solid or dashed) is visible at the edge of the tile (whatever side the frame is off) while the rest of the frame is smaller, as if the entire frame is visible.

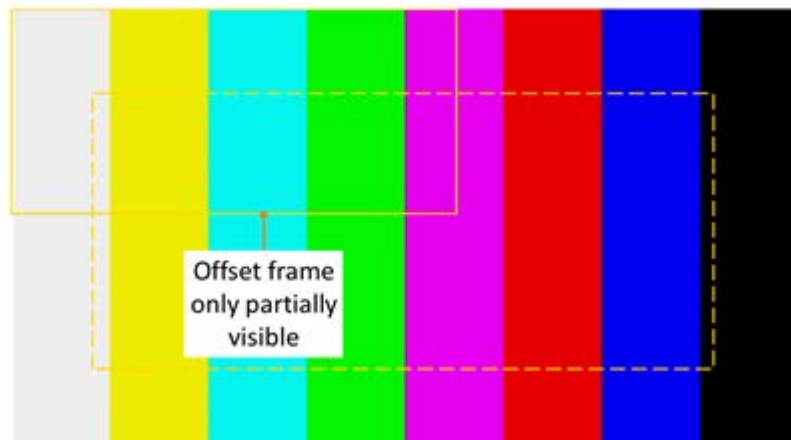

- D. Select **Save Custom**. The Custom Safe Areas (Action and Title) are updated in the selected Picture tile when they are turned on in the Picture settings menu. For details about turning on Custom Safe Areas, see [Select Safe Area Graticules](#).

Configure Graticule Colors

1. Select the **Settings** icon ().
2. Select **Display** and then select **SAFE AREA GRATICULES**.
3. In the Safe Area Graticules menu, select the safe area element menu to select a color.
 - Safe Area Action 1 and Title 1
This color is for both the Custom 1 Safe Area *Action* (solid line) and Custom 1 Safe Area *Title* (dashed line).
 - Safe Area Action 2 and Title 2
This color is for both the Custom 2 Safe Area *Action* (solid line) and Custom 2 Safe Area *Title* (dashed line).
 - Picture Center Graticule
This color is for the Picture Center Graticule.
 - AFD Graticule
This color is for the AFD frame.

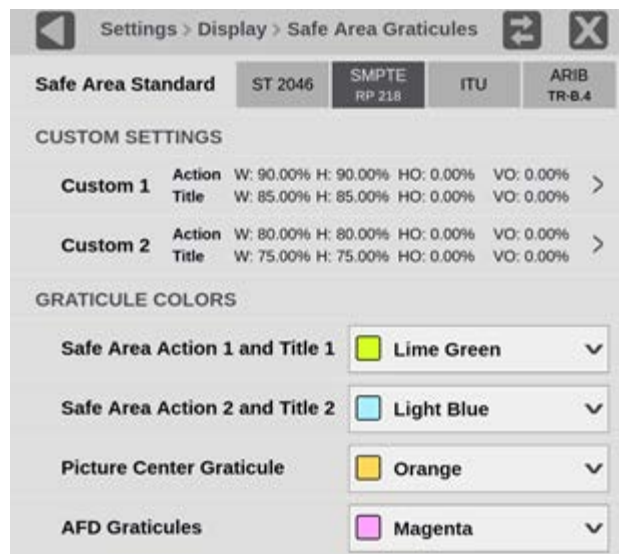

Set Trace and Graticule Intensity

The brightness of an application graticule and trace can be adjusted with the intensity controls in the Display Settings menu.

To adjust graticule and trace intensity:

1. Select the **Settings** icon ().
2. Select **Display**.
3. Select **TRACE AND GRATICULE INTENSITY**.

4. Select the **Plus** icon (➤) to increase intensity or the **Minus** icon (◀) to decrease intensity of the trace or graticules.

Note: You can also adjust the intensity by selecting anywhere in the control or by selecting and dragging the selector circle left or right.

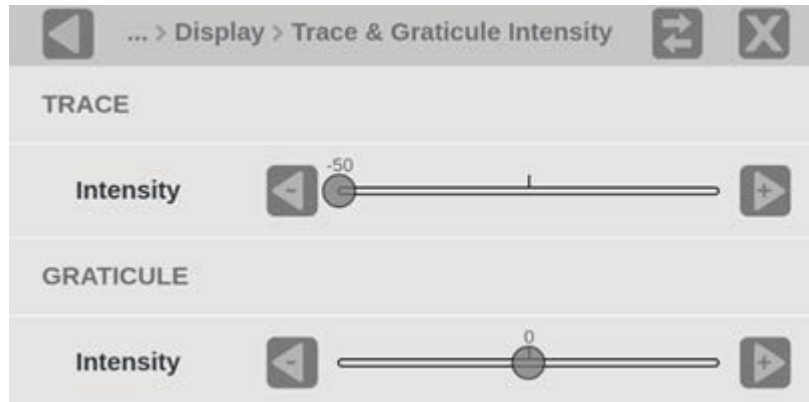

Enable Picture Low Latency Mode

If you enable Picture Low Latency Mode, you can quickly toggle between inputs, for SDI and IP. Picture Low Latency Mode minimizes the PRISM signal path latency, allowing users to more quickly see signal changes on the local Picture display, such as input changes. Low-latency mode improves the picture display response at the expense of additional picture judder. When low-latency mode is disabled (the default), the moving content of pictures transition smoothly, but the picture response time is longer.

To enable Picture Low Latency Mode:

1. Select the **Settings** icon (⚙️).
2. Select **Display**.
3. To enable Picture Low Latency mode, set the Picture Low Latency Mode control to **On**.

Note: Picture Low Latency mode may introduce motion artifacts.

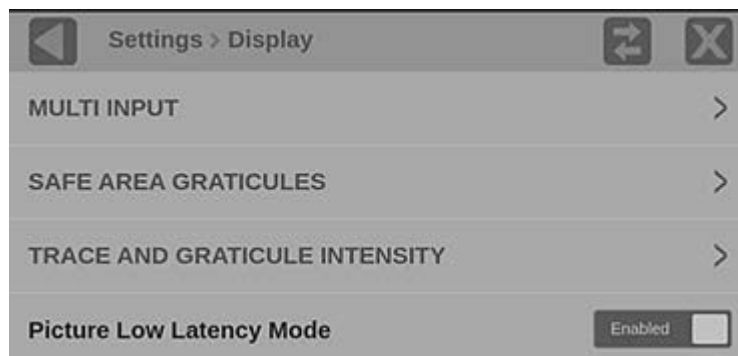

Configure Time and Date

This section explains how to set the internal time and date used by the instrument to record events. It also explains how to change the clock available on the status bar between PTP and RTC.

Note: When the time and date settings are changed, the instrument must be rebooted to implement the changes.

1. Select the **Settings** icon ().
2. Select **Utilities**.
3. Select **Time and Date**. The submenu has two tabs: TIME SETTINGS and RTC CLOCK.

Update Time Zone

1. In the **Time and Date** menu (to open the menu, see [Configure Time and Date](#)), select **TIME SETTINGS**.

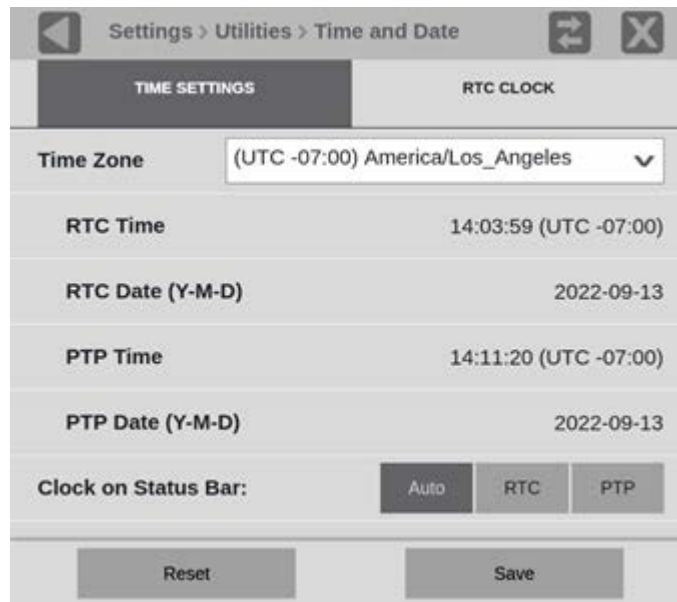

2. Select the **Time Zone** menu and select the correct time zone offset for your location. The selection names include the time offset from UTC and major cities in those time zones.
3. Select **Save** to update the clock. A reboot is not required to change the time zone.

Change Status Bar Clock

Note: The RTC or PTP clock in the status bar is set automatically to local time.

1. In the **Time and Date** menu (to open the menu, see [Configure Time and Date](#)), select **TIME SETTINGS**.
2. In Clock on the status bar, select **Auto**, **RTC**, or **PTP**.

Note: The Auto setting searches for a PTP signal; if one is not available, it selects RTC.

3. Select **Save**. A reboot is not required to change the status bar clock.

Update RTC Clock

1. In the **Date and Time** menu (to open the menu, see [Configure Time and Date](#)), select **RTC CLOCK**.
2. Adjust the time and date using the up and down arrows as needed.
The time setting uses a 24-hour clock, so no AM/PM setting is required.

The screenshot shows the 'RTC CLOCK' settings screen. At the top, the breadcrumb path is 'Settings > Utilities > Time and Date'. Below this, there are two tabs: 'TIME SETTINGS' and 'RTC CLOCK', with 'RTC CLOCK' being the active tab. The screen displays the following information:

- Current Time:** 11:30:01 (UTC -07:00)
- Current Date (Y-M-D):** 2021-08-30
- A warning message: **Make sure Time Zone is properly set before adjusting Time and Date.*
- Time (H:M:S):** A digital display showing 11:22:13. Each digit (11, 22, 13) is in a separate box with up and down arrows for adjustment.
- Date (Y-M-D):** A digital display showing 2021-08-30. Each digit (2021, 08, 30) is in a separate box with up and down arrows for adjustment.
- At the bottom, there are two buttons: 'Reset' and 'Save'.

3. When you are done setting the time and date, select **Save**.
4. The message box asks you to confirm that you want to reboot the instrument to implement the time and date changes:
 - Select **OK** to reboot the instrument immediately and implement the changes.
 - Select **Cancel** to end the operation.



Upgrade Instrument Firmware

Telestream releases updates to product firmware to add new features or to fix reported problems. Check the Telestream website regularly for new firmware releases.

Before Upgrading

 **CAUTION: After upgrading to 4.x, it is not possible to downgrade to an earlier version without assistance from Telestream technical support.**

You do not need to perform a firmware upgrade if the instrument has the latest version of firmware already installed. To determine if the firmware on your instrument must be upgraded:

1. Power on the instrument.
2. Verify the current software version installed on the instrument:
 - A. Select the **Settings** icon () and select **Utilities**.
 - B. Select **Version** and in the Software section and note the version number installed on the instrument.

Instrument firmware version number

3. Verify the latest version of firmware at the Telestream website:
 - A. Use a web browser and go to the Telestream website software page: www.telestream.net/video/resources.htm#Software.
 - B. Select the product and model title that best matches your instrument (such as PRISM) and in the list, find the software-upgrade package for your instrument.
 - C. Note the latest version number of the software-upgrade package(s).

Website firmware version number

4. If the latest firmware version at the website is newer than the version on your instrument, you should upgrade the firmware.
5. Select the Firmware Release version for your instrument to download the update.



CAUTION: After the instrument has started the upgrade process, **DO NOT** remove power from the instrument. If you do, the instrument flash will be corrupted. The instrument must be sent to a Teletream factory service center to have the system firmware restored.

6. Go to [Upgrade Firmware](#).

Note: The time required to complete the upgrade is about 15 minutes.

If you want the details of what has changed in the release, download the Release Notes for the version.

Note: If power to the instrument is lost before it begins erasing the internal flash, you can restart the firmware upgrade after the instrument reboots.

Upgrade Firmware

1. On an Internet-enabled computer, prepare a formatted (FAT32), non-bootable USB drive. It needs at least 2 GB of available space.
 2. Unzip the PRISM file and copy the upgrade file with a .ubin file extension from the upgrade package onto the USB drive.
-

Note: The upgrade package includes an MD5 checksum and a PDF file, read the PDF file before performing the upgrade. The file contains important information about the firmware release.

3. Remove the USB drive from the computer and insert the USB drive into a USB port on the PRISM monitor.
4. On the PRISM monitor, select the **Settings** icon () and select **Utilities**.
5. Select **Firmware Upgrade**. After the USB device has been scanned, the display lists all of the files on the USB device with a .ubin file extension.
6. Select the file in the list and then select **Install** to start the upgrade.
When the upgrade begins, a message box appears stating that the firmware installation is in progress.

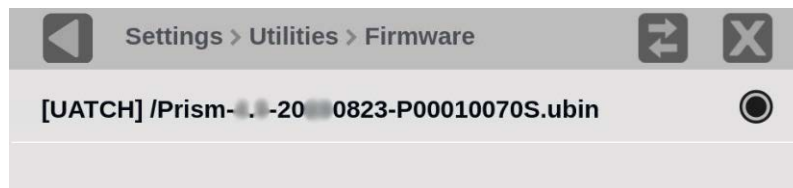





CAUTION: Removing the USB device or powering off the instrument before the upgrade is complete can cause upgrade failure. To prevent upgrade failure, wait until the Installation Complete message box is displayed before performing these actions.

The upgrade might take up to 5 minutes.

1. When the install is complete and the reboot options are available, select **Reboot Now**.



2. Select the **Activity** icon () to view the devices mounted to the instrument.
3. Select the **Eject** icon () to unmount the USB drive from the instrument.
4. Remove the USB device from the PRISM monitor.
5. Shut off the instrument:
 - A. Select the **Settings** icon () and select **Utilities**.
 - B. Select **Power** and select **Power Down Now**.
6. Disconnect the instrument from AC power.
7. Reconnect the instrument to AC power.
8. Press the power button on the instrument front panel to turn the instrument on.

Verify Firmware Upgrade

1. Select the **Settings** icon ()
2. Select **Utilities** and then select **Version**.
3. Verify that the displayed firmware version number matches the version of the firmware upgrade package you installed.

Upgrade Software License

A software license upgrade allows you to add optional software features to your instrument. Go to www.telestream.net for the latest list of features that can be licensed

Install Software License Upgrade

To activate the licenses, the instrument must be accessible by another computer on the local network. Your instrument does not need to access the Internet.

To activate the licenses:

1. Connect the PRISM instrument to a local network and turn power on.
2. After the instrument has powered on, find the IP address:
 - A. Select the **Settings** icon () and then select **Network**.
 - B. Select the **STATUS** tab and note the IP Address.
3. Enter the IP address in a web browser.
4. Select **License Portal** and follow the instructions on the page.

For further assistance, contact our technical support team:

www.telestream.net/telestream-support/video/support.htm.

Verify Software License Upgrade

1. Select the Settings icon ()
2. Select **Utilities** and then select **Options**.
3. Verify that the displayed options match the options you installed.



Troubleshooting

There are a few procedures for maintenance of a PRISM.

Create Diagnostics File

If the instrument needs service, you may be asked to provide the diagnostics file to Telestream to aid in understanding any problems with the instrument.

To download a zip file containing a service report of instrument diagnostics:

1. Select the **Settings** icon ()
2. Select **Utilities** and then select **Diagnostics**.
3. Insert a USB device into one of the USB ports on the PRISM instrument.
4. Select **Save Diagnostics** to save the diagnostics report to the USB device.
5. Select the Activity icon () and then select the **Eject** icon () to unmount the USB drive from the instrument.

Find PRISM Original Model

There are some conditions when it is necessary to know the original model of a PRISM, to tell if it has been upgraded.

To find the original model of a PRISM:

1. Select the **Settings** icon (⚙️).
2. Select **Utilities** and then select **Option**.
3. The Nomenclature field lists the model it was shipped as, before any upgrades.
 The first example shows an instrument that is an MPI.

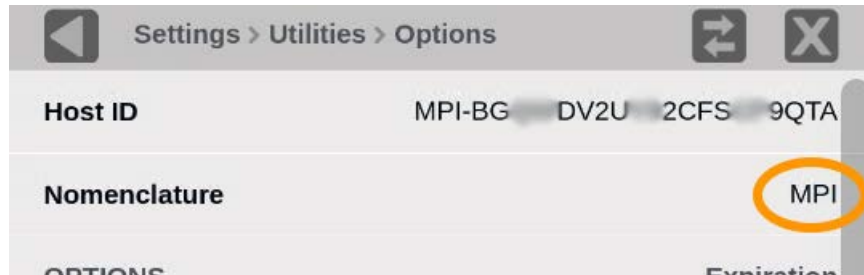

The second example shows an instrument that is an MPI2-25.

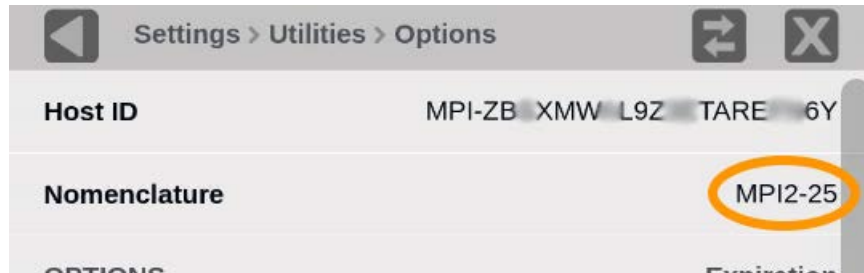

Functions

This chapter describes additional functions available on the PRISM monitor:

- Headphone and speaker volume, balance, source adjustment, and downmix
- Stream Capture

Headphone or Speaker Volume, Balance, Device, and Source Adjustment

Headphones can be connected to MPI2-25 or MPX2-25 products:

- MPI2-25 audio output rear panel connector
- MPX2-25 audio output rear panel connector or front panel headphone port

To access the volume, balance, and source controls, select the **Volume** icon ().

The available options:

- Select the audio device to use.
- Select the source from the list of available channel pairs.
- Use the control or arrow buttons to turn the volume up or down.
- Use the control or arrow buttons to adjust the audio balance left or right.
- Select the mute button to mute the audio.
- Select the downmix button to listen to a downmixed group of channels.

If the downmix button is not visible (the example shows the downmix button) the Program configuration might not be on or set.





Downmix Controls

Downmix combines channels to monitor them grouped as stereo or mono. There are several options for ways to hear combined channels.

Enable Downmix Button

Note: The Dolby program configuration is based on metadata; no user input is needed. Downmix buttons are added to the Volume controls if they are applicable. See [Configure DOLBY](#).

1. Select the **Settings** icon ().
2. Select **Inputs**.
3. Select the input with the channels to downmix.
 - A. If the input is SDI, select **AUDIO**.
 - B. If the input is 2022, select **AUDIO**.
4. Check the Program Configuration is on and configured for the input.
5. Select **Save**.
6. Select the **Volume** icon (). The Downmix button is visible.

Set Downmix Mode

With the downmix parameters set, select one of the Downmix Mode options in the Settings Audio menu:

1. Select the **Settings** icon ().
2. Select **Audio**.

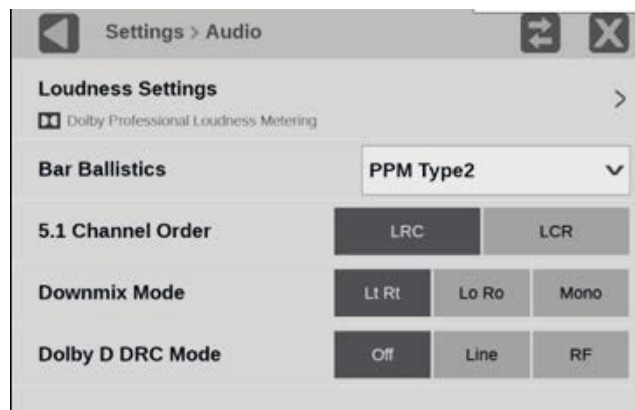

- **Lt Rt** (left-total and right-total, a stereo Pro Logic mix): Reduces the stream to two channels. The center channel is reduced 3dB, the surround channels are added together to create a single signal and reduced 6dB, and the LFE is muted. The surround signal is added 180 degrees out of phase to the left-and-center signal, making up the left-total channel. The surround signal is added *in* phase (0 degrees) to the right-and-center signal, making up the right-total channel.
- **Lo Ro** (left-only and right-only, a stereo only downmix): Reduces the stream to two channels. The center channel is reduced 3dB, both surround channels are reduced 3dB, and LFE is muted. The center channel is added to the left-and-left-surround

signal to make the left-only channel. The center channel is added to the right-and-right-surround signal to make the right-only channel.

- **Mono:** Reduces the stream to one channel. The center channel is reduced 3dB, the surround channels are each reduced 3dB, and the LFE is muted. All six channels are combined.

Access Downmix Control for Input 2110-30 with Multiple Audio Streams

This section only applies to original MPI and MPX instruments that have been upgraded with a 25Gb media board. This does *not* affect MPI2-25 or MPX2-25 instruments, or MPI2-10 or MPX2-10 instruments upgraded with a 25Gb media board. To tell if an instrument has been upgraded, see [Find PRISM Original Model](#).

Note: In original MPI or MPX instruments upgraded with a 25Gb media board, the downmix is available only when input 2110-30 uses a single audio stream.

To enable single-stream downmix control:

1. Select the **Settings** icon ().
2. Select **Inputs**.
3. Select the input from the audio signal to downmix.
4. Select **IP**, then select **ST2110** and then select **Audio (2110-30)**.
5. If there are multiple enabled audio streams, disable all the streams except the stream you want to downmix.

Video (2110-20)	Audio (2110-30)	Data (2110-40)
Audio Streams		4
Stream 1	P1- Dst: 239.30.14.17 :50030 Type: 97 CH: 8 Mapped	>
Stream 2	P1- Dst: 239.30.11.17 : Masked Type: 97 CH: 8 Mapped	>
Stream 3	Not Enabled Mapped	>
Stream 4	Not Enabled Mapped	>

- A. Select a stream you do *not* want to hear and set **Enable Audio Stream** to **Disabled**.

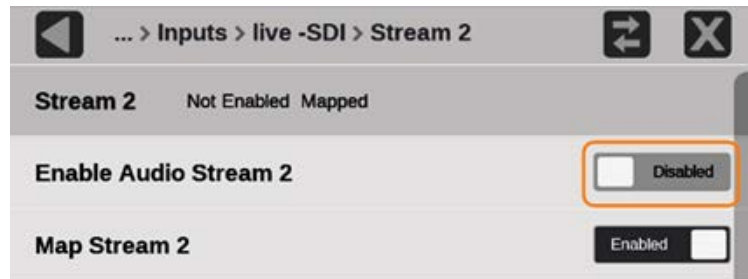

B. Select **Save Stream**.

C. Repeat Steps A and B for all enabled streams except the stream you want to downmix.

Audio Controls

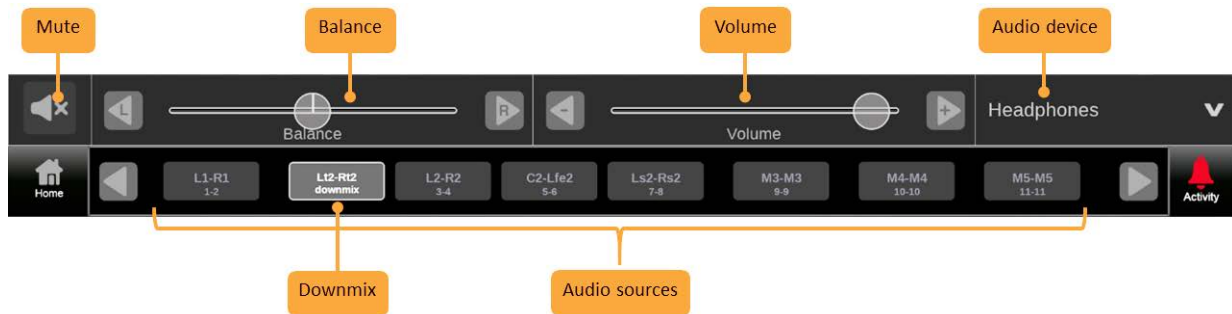

Audio Control Features and Descriptions

Option	Description
Mute	Mute or unmute audio.
Balance	Left and right balance control of selected audio pair.
Volume	Volume control of selected audio pair.
Audio device	Output audio device to control. This can be headphones using the audio ports or USB inputs. The name of the audio device in the list depends on what port is used and the device itself: <ul style="list-style-type: none"> • Headphones: Headphones plugged into the front or rear panel audio ports • USB AUDIO DAC: Headphones plugged into the external display product audio ports • Unknown: Unidentified audio device plugged into the front or rear panel USB ports • If a USB audio device supports device descriptors, the vendor supplied device name appears in the list.

Audio Control Features and Descriptions

Downmix	Audio channel group to monitor channels mixed down to stereo or mono (visible when only Program Configuration is on and set).
Audio sources	Audio channels available to monitor.



WARNING: To avoid damaging your hearing, always turn the volume down to the minimum before you put on headphones and then turn the volume up slowly.

Capture

The Capture feature has two modes: Screenshot and Stream.

- Screenshot capture takes an image of the entire screen and saves it to a USB drive.
- Stream capture creates a PCAP file capturing up to 2 GB of data on a USB drive for further analysis. Both modes are useful for comparing sources or capturing transient events.

Requirements to use the Capture feature:

- MP2-IP-MEAS option installed
- USB 3.0 drive connected to the rear panel of the PRISM monitor

Note: For the fastest capture rate with the Stream Capture, we recommend using a USB 3.0 drive plugged into one of the USB 3.0 ports on the rear panel of the instrument. Using a USB 2.0 drive or USB 2.0 ports can cause the stream capture to take longer.

Note: Maximum stream capture PCAP files are approximately 2 GB in size.

Capture Screenshot

1. From the **Settings** menu, select **Capture**.

Note: If the Capture configuration menu does not appear under the Settings menu, option MP2-IP-MEAS is not installed, but screen captures are still functional.

2. Select **Screenshot** under SELECT CAPTURE TYPE.

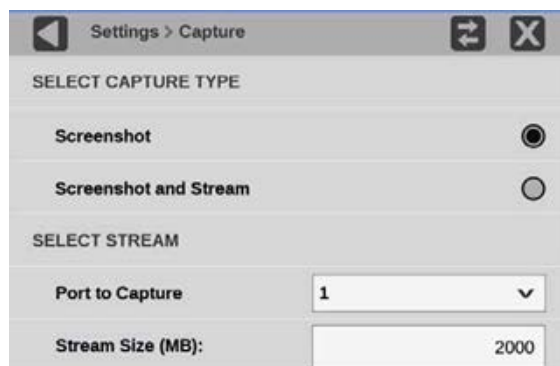

3. On the application bar, select the **Capture** icon (.



A screenshot is saved to the device.

Note: If you need to remotely save a screenshot to a flash drive, use VNC. If you need to remotely save a screenshot, use the API command <http://aaa.aaa.aaa.aaa/api/downloadScreenshot> or save a screenshot to a flash drive using VNC.

Perform Stream Capture

1. Verify that there is a USB drive connected to the PRISM monitor.
2. Select the **Settings** icon () and then select **Capture**.

Note: If the Capture configuration menu does not appear under the Settings menu, option MP2-IP-MEAS is not installed and stream captures are disabled.

3. Select **Screenshot and Stream** under SELECT CAPTURE TYPE.
4. Select the **Port to Capture** menu and select from inputs (10/25GE SFP) 1 or 2.

Note: When capturing on a port configured for 25-Gb data rate, the maximum total bit rate on the port must be less than 15 Gbps. Data packets captured in the PCAP file may be dropped if the total bit rate exceeds this limit.



5. In the **Stream Size (MB)** box, type the size of the capture.

Note: The minimum stream size is 1MB and the maximum size is 2000 MB.

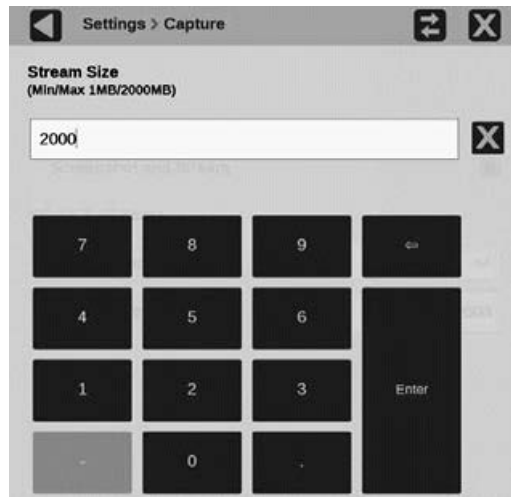

6. Select the **Close** icon (X).

7. On the application bar, select the **Capture** icon (📷) to start the process. When the capture type is Screenshot and Stream, a percentage is displayed under the Capture icon.

Note: During capture, the Aux Out signal is turned off and Pictures and Traces are blanked.

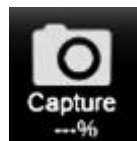



Note: Select the Capture icon again to stop the stream capture early. The Capture icon is the only element you can interact with on the PRISM monitor while the capture and save are taking place.

A screenshot and .pcap file are saved to the attached USB drive. The name of the file and the path to the file on the USB drive are displayed after the save is complete.

8. Select **OK** to close the menu.

Application Information

This chapter describes the monitoring and measurement applications available on the PRISM monitor. Each of these applications can be viewed in quarter-screen, half-screen, or full-screen mode; double tap in the application to change between modes.

To view the All Applications menu, select the **Tiles** icon () and then select the **All Applications** menu icon (.

Note: Some displays require a specific option to be installed. For example, the IP Graph display is not accessible unless you have Option MP2-IP-MEAS.

Application Options

This section describes the application groups.

Base Instrument Applications

Unless otherwise noted, these applications are available on every PRISM monitor:

Note: The SD; HD 720p, 1080p, and 1080i; and 3G Level A formats can display up to eight trace applications at a time. All other formats can display up to four trace applications at a time. The trace applications are Waveform, Vector, Stop, Diamond, Lightning, and CIE.









Application Icons	Description
-------------------	-------------



Waveform Application: View the voltage versus time display of the video signal.





Vector Application: Call up the Vector, which plots color difference signals for viewing hue and amplitude, but not luminance.

Application Icons	Description
	<i>Lightning Application:</i> View luma and chroma amplitudes and verify component timing using a color-bar signal.
	<i>Diamond Application:</i> Detect invalid colors.
	<i>Picture Application:</i> View the picture decoded from the incoming video signal.
	<i>Video Session Application:</i> View information about the format of the signal and metrics for SDI Format, VPID ST 352, Bit Level, and CRC Status.
	<i>Audio Application:</i> View audio bar levels for the monitored signal with Test Level and Peak Program indicators. (Lissajous display and Channel Correlation meter for monitoring two-channel audio phase and Audio session require Option MP2-AUD.)
	<i>Event Log Application:</i> View a log of detected errors.
	<i>IP Status Application:</i> See an overview of the monitored IP stream and see the status of each program in the stream.
	<i>Timing Application:</i> View timing offsets between the incoming SDI video signals and Black Burst / Tri-Level Sync external reference signals.
	<i>IP Display Application:</i> Use the Display application to send the tiled PRISM display as an ST 2110 stream for multiviewer applications. This application is available only in the 200 and 300 versions of MPS, MPD, and MPP.

Option MP2-PROD

This supports SDI and 2110 Deep Color formats, see tables [Supported SDI Formats](#) and [Supported Video Formats in ST 2022-6 Streams](#). It also supports this feature and these additional applications, which are available when option MP2-PROD is installed, unless otherwise noted:

Convert to Rec. 709: This feature adds a setting to allow the trace displays to convert camera logs to Rec. 709.

Application Icons	Description
	<i>Stop Display Application:</i> Monitor video signals with a variety of transfer functions in a consistent manner.
	<i>CIE Application:</i> Check the chromaticity of the video against various color gamut limits.

Option MP2-JPXS

This option enables you to monitor 2110-22 JPEG XS inputs and adds a tab to the Video Session application if the current input is JPEG XS.



Option MP2-MULTI

This option enables monitoring up to 4 SDI inputs. Without this option only 1 SDI input can be monitored.

Application Icons	Description
	<i>CAM Application:</i> Use this application to check the color levels and balances between up to four camera inputs.

Option MP2-AUD

This additional application is available when Option MP2-AUD is installed:

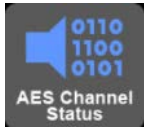

Application Icons	Description
	<i>Audio Application:</i> This option adds Lissajous, Session, Correlation, and Loudness capabilities to the existing Audio application.
	<i>Dolby Status Application:</i> View metadata content in the selected Dolby audio stream or carried in VANC data ST 2020.
	<i>AES Channel Status Application:</i> View AES data related to the SDI input audio channels.

Option MP2-DLBY

This option enables full decoding of Dolby E, D, and D Plus signals. It also enables decoding of ED2 metadata.

Option MP2-ENG and MP2-QC

These additional applications are available when Option MP2-ENG or MP2-QC is installed, unless otherwise noted:







Application Icons	Description
	<i>Picture Application:</i> Adds the ability to decode and display closed captions or subtitles in CEA 608, CEA 708, OP47/ST2031, and ARIB B24 to the existing Picture application.
	<i>Datelist Application:</i> View the digital data contained in SDI frames to perform in-depth monitoring and analysis of incoming SDI data.
	<i>ANC (Ancillary Data) Session Application:</i> Monitor all ancillary data present in a signal.

Application Icons	Description
	<p><i>Audio-Video Delay Application:</i> Measure the audio-to-video synchronization (lip sync) when using a Flash Pop test sequence that can be generated from the Telestream Sync Pulse Generator.</p>

Option MP2-IP-MEAS



These additional applications and feature are available when option MP2-IP-MEAS is installed, unless otherwise noted:

IP Stream Capture: This feature allows the capture IP streams to a PCAP file. The maximum capture size is 2 GB, which allows for the capture of 10 seconds of HD video.

Application Icons	Description
	<p><i>IP Session Application:</i> View various performance parameters of the IP stream including Layer 2, video, and PTP parameters.</p>
	<p><i>IP Graphs Application:</i> View trend graphs of various performance parameters of the IP stream including total bit rate, session bit rate, PIT, RTP sequence errors, video CRC errors, and TS-DF (Time Stamped Delay Factor).</p>
	<p><i>PIT Histogram Application:</i> View a histogram of the PIT (Packet Interval Time) to monitor network delay variation statistics.</p>
	<p><i>PTP Graphs Application:</i> View trend graphs of various performance parameters of the PTP signal include leader-to-follower and follower-to-leader delays and variances.</p>
	<p><i>Stream Timing Application:</i> View the timing of the ST 2110 video, audio, and data as it was received relative to the embedded RTP timestamps.</p>
	<p><i>Timing Application:</i> (for IP signals): Adds features to the standard Timing application, such as viewing timing offsets between the incoming ST 2022-6 and ST 2110-20 video signals and PTP signals.</p>



Option MP2-PHY

These additional applications are available when Option PHY is installed (software option MP2-FMT-4K required for 12G support):

Application Icons	Description
	<i>Eye Application:</i> View an eye pattern diagram of the SDI input only.
	<i>Jitter Application:</i> View the wave shape of the jitter and additional time-domain information.

Option MP2-GEN

Unless otherwise noted, these additional applications are available when option MP2-GEN is installed:

Application Icons	Description
	<i>IP Generator and IP Display Applications:</i> Use the Generator function to send an ST 2110 test stream for checking a receiver device and signal path. Alternately, use the Display function to send the tiled PRISM display as an ST 2110 stream for multiviewer applications. This application is available only on the 200 and 300 versions of MPS, MPD, and MPP.
	<i>SDI Generator Application:</i> Provides an SDI test signal to check the receiver device and signal path.

Option MP2-EXTNDSP

This option enables using eight separate tiles; a second monitor is required. Without this option only four tiles can be used and a second monitor duplicates the four tiles on the first monitor.





Note: MPX2 models can also be operated with no monitors attached for remote monitoring. If monitors are attached to the MPX2, they must both be the same transport, Display Port or HDMI, not mixed, (through DP1 and DP2 connections with adapters).

View Installed Options

To view options installed on the instrument, select the **Settings** icon (), select **Utilities**, and then select **Options**.

Status Indicators

Many of the application displays include status icons, which provide a quick way to view signal status. These icons may appear:

-  The signal parameter has not been in an error condition.
-  The signal parameter was in an error condition but the error has cleared.
-  The signal parameter is in an error condition.
-  The signal parameter is not being monitored for an error condition.

Waveform Application

The Waveform display is a signal-level-versus-time display of the video signal.

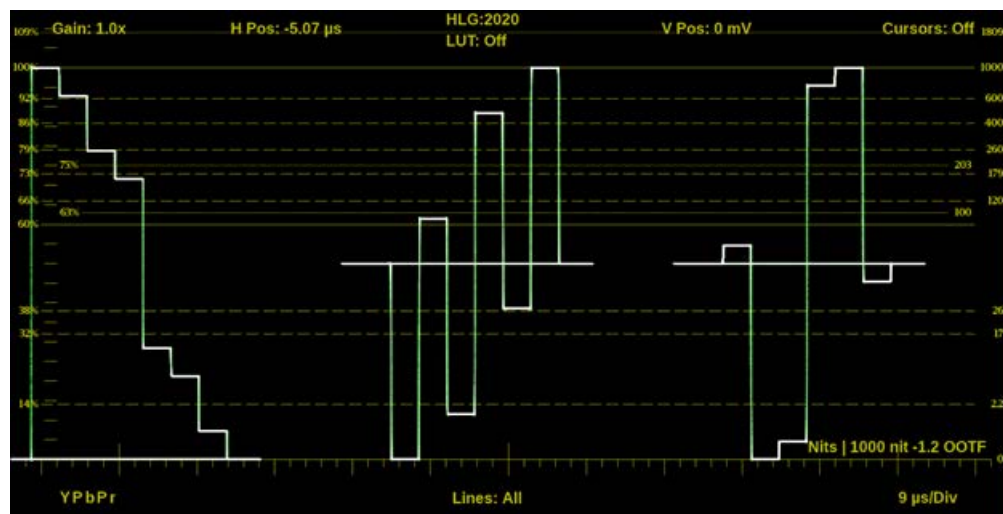

Waveform Settings

To configure the Waveform settings:

1. Select the **Tiles** icon ().
2. Select the tile with the Waveform application.

3. Select the **Tile** icon ().

Note: To move the settings left or right, select the **Move** icon () in the Settings menu header.

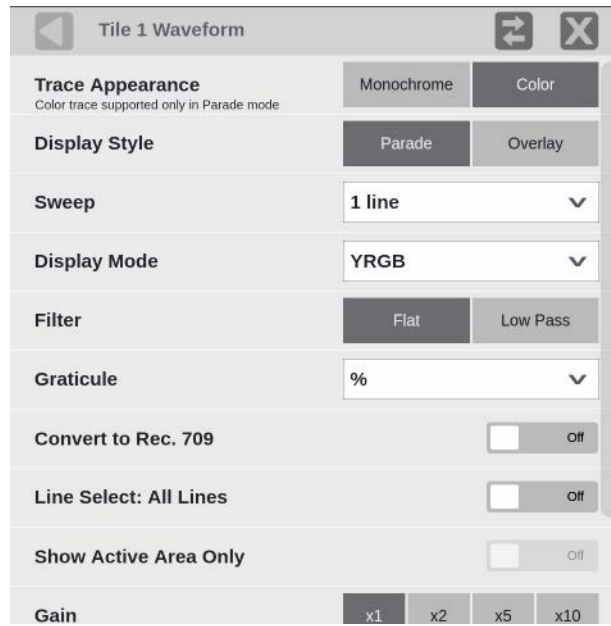

4. In the **Trace Appearance** section, select the colors for the parade traces:
- **Monochrome:** To display all traces in a conventional green.
 - **Color:** To display the components of the traces in the colors described in the Display Mode; for example, the components in RGB mode are shown in red, green, and blue.

Note: The Color setting works only when Display Style is set to Parade. The Overlay mode displays the traces in green.

5. In the **Display Style** section, select how signal components are displayed in the active tile:
- **Parade:** All components are shown one beside the other. This setting allows the traces to appear in the described colors if it is selected in Trace Appearance.
 - **Overlay:** All components are drawn at the same location so they appear one on top of the other. This trace is always displayed in green.
6. From the **Sweep** list, select the waveforms to view between the lines or fields. The options depend on the active display style.
- When the Parade display style is active, you can select **1 line** or **1 field**.
 - When Overlay display style is active, you can select **1 line**, **2 line**, **1 field**, or **2 field**.

7. In the **Display Mode** list, select the display mode (available only while displaying SDI inputs):

Note: The inputs are shown in their colors only if Trace Appearance is set to Color.

- **Y:** Displays the input as White (Y) for the Luma component. This display is the YRGB mode with the Red (R), Green (G), and Blue (B) components turned off.
 - **RGB:** Displays the input as R, G, and B components.
 - **YPbPr:** Displays the input as Y for the Luma component, and color difference Cyan (Pb) and Magenta (Pr) components.
 - **YRGB:** Displays the input as Y, R, G, and B components.
8. Waveform filters are useful for isolating a specific characteristic of the input. For example, you can enable a Low Pass filter for quick camera exposure setting. In the **Filter** section, select a waveform filter:
- **Flat:** Display the full available bandwidth.
 - **Low Pass:** Display only the low frequency part of the signal.
9. From the **Graticule** list, select a vertical scale value.

Note: The Code Value vertical unit is a hexadecimal value. The Stop, Reflectance, and Nits scale are drawn differently depending on the gamma setting in the Input menu.

In the Waveform display application, select the **Graticule** menu to choose the graticule that fits your need. The trace represents the video data in the vertical axis.

- The mV, %, and Code Value are fixed graticules. They are compatible with the traditional waveform scales.
- The Reflectance and Stop graticules vary depending on the Gamma selection in the Input Settings menu. These are the Scene light graticules that are used for scene setting and camera exposure adjustment.
- The Nits graticule varies depending on the Gamma selection in Input Settings menu. This is the Display light graticule and is used for mastering the content for a targeted HDR system.

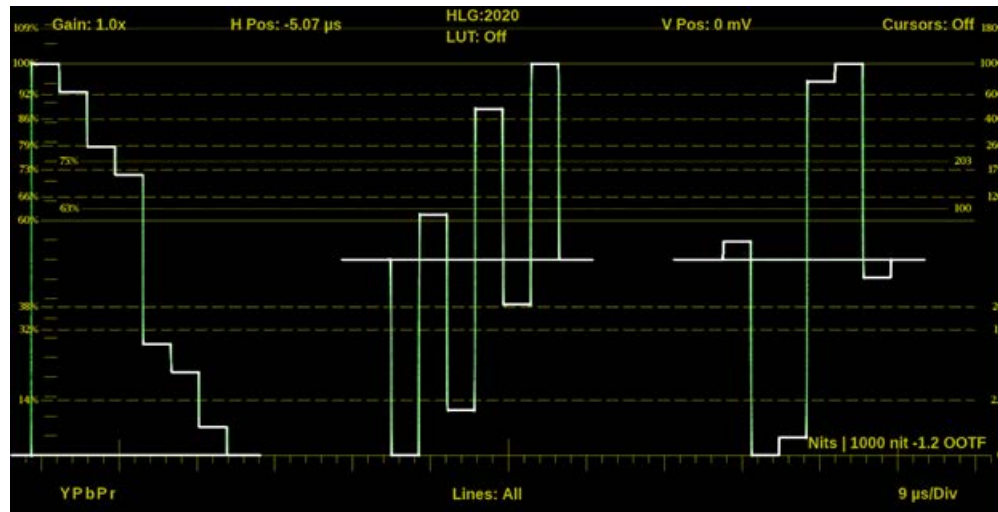

10. Set **Convert to Rec. 709** to **On** to allow trace displays to convert the Gamma and Color Gamut settings for the signal to SDR Narrow and BT.709 (requires Option MP2-PROD).

Note: Conversion to Rec. 709 automatically converts to BT.709, otherwise the graticule selection must be manually changed. (See [Configure Instrument for HDR/WCG Monitoring](#).) Conversion to Rec. 709 mode is not supported for SD signals.

11. Set **Line Select** to **On** to select 1 Line or **Off** to select All Lines. When Line Select is set to On (Line Select: Line 1), the display shows only results for the selected line in the picture. You can use on-screen tools to select the line; see [Line Select Function](#). Alternatively, you can select the line directly on the Picture.
12. To remove the trace of vertical and horizontal blanking data, set **Show Active Area Only** to **On**.
13. In the **Gain** section, select **x1**, **x2**, **x5**, or **x10**.
14. In the **Magnification** section, select **Best**, **x1**, **x10**, **x20**, **x25**, or **x50**.

Waveform Application On-screen Tools

You can change the gain, horizontal position, vertical position, gamma LUT, cursors, display mode, display format, and selected line, without opening the Waveform Settings menu, through on-screen tools. Select the button for the setting you want to adjust. All the available tools are located on the top and bottom of the display and are highlighted for a few seconds when the application is first opened or if you select in the tile heading.

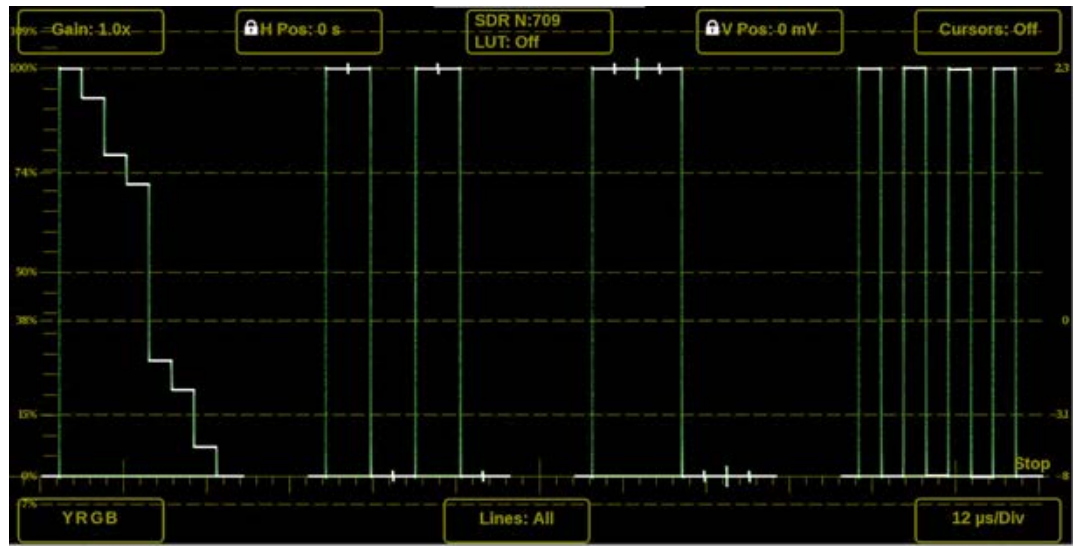

Gain

Increase or decrease the magnification of the trace display.

1. Select **Gain** to open the magnification menu.
2. Select a preset magnification for fixed gain.
3. Select the **Gain** (the number varies) button; select **VAR: Off** to change it to VAR: On. Variable gain allows flexibility in changing the gain factor between 0.5x to 20.0x. The limits of the variable gain change depend on the gain factor you select.
 - 1.0x has a range of 0.25x to 4.00x gain.
 - 2.0x has a range of 0.50x to 8.00x gain.
 - 5.0x has a range of 1.25x to 20.00x gain.
 - 10.0x has a range of 2.50x to 40.00x gain.

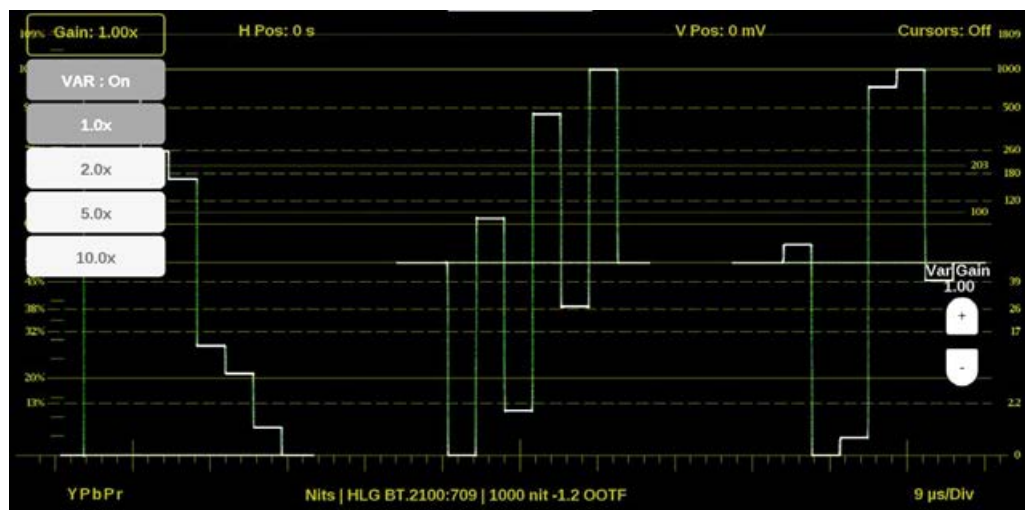

To adjust the gain:

- On a touchscreen, use a pinch gesture to change the scale of the trace for large increments.
- For small increments, select the **Plus (+)** button or **Minus (-)** button to adjust the gain.
- Use the scroll wheel on a mouse to adjust the variable gain.
- Use the **Reset** icon () to remove variable gain adjustments.

Horizontal and Vertical Position

Adjust the position of the trace display.

1. Select the **H Pos** button to allow incremental adjustment of the horizontal trace.
 - Select-and-drag to move the trace on the touchscreen. This method can be performed without using the button.
 - Use a mouse scroll wheel to move the trace.
 - For incremental adjustments, select the **Plus (+)** button or **Minus (-)** button to adjust the horizontal position.
 - Select the **Reset** icon () to reset the horizontal position adjustment to default.



2. Select the **V Pos** button to adjust the vertical trace.
 - Select-and-drag to move the trace on the touchscreen. This method can be performed without using the button.
 - Use a mouse scroll wheel to move the trace.
 - For incremental adjustments, select the **Plus (+)** button or **Minus (-)** button to adjust the vertical position.
 - Use the **Reset** icon () to reset the vertical position adjustment to default.

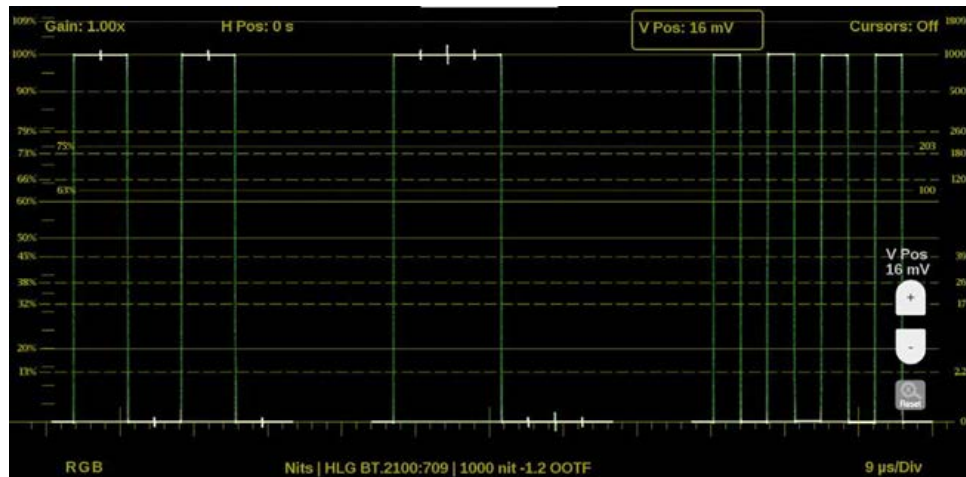

Gamma LUT

Turn the Gamma LUT on or off:

1. Select the **LUT** button (other elements in the button are variable depending on the options selected) in the upper middle of display.
2. Select the lower **LUT:** button to set the Gamma LUT on or off.

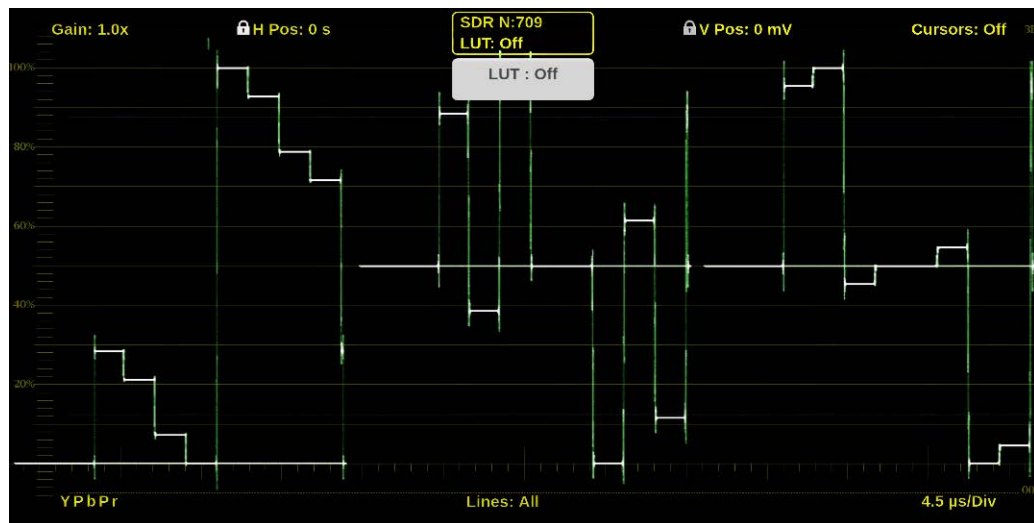

To change the gamma curve and color gamut (displayed in the LUT button):

1. Select the **Settings** icon (⚙️).
2. Select **Inputs** and select the input being used.
3. Select **SDI** and **VIDEO**.
4. From the **Gamma Curve** list, select one of the following; the selection characterizes the video signal on each virtual input.
 - **Auto:** The system selects the setting based on ST 352 VPID. If 352 VPID is not present, SDR Narrow is selected.

- **SDR Narrow:** The reference OETF (Optical to Electrical Transfer Function) is defined in ITU-R BT.709 with gamma of 0.45 and the reference EOTF is defined in ITU-R BT.1886 with gamma of 2.4.

The Narrow scaling places the extremes of the nonlinear color value from zero to unity at code words 40 hex (64 dec) and 3AC hex (940 dec) in a 10-bit representation for 0% Black to 100% White. This range is typical for standard-dynamic range.

- **SDR Full:** The reference OETF is defined in ITU-R BT.709 with gamma of 0.45 and the reference EOTF (Electrical to Optical Transfer Function) is defined in ITU-R BT.1886 with gamma of 2.4.

The full scaling places the extremes of the nonlinear color value from zero to unity at code words 0d and 1023d in 10-bit representation and 0d and 4095d in 12-bit representation for 0% black and 100% white, respectively.

- **PQ Narrow:** The reference OETF with a high luminance range capability of 0 to 10,000 cd/m² standardized in ST 2084. The EOTF is the inverse of OETF.

The narrow scaling places the extremes of the nonlinear color value from zero to unity at code words 40 hex (64 dec) and 3AC hex (940 dec) in a 10-bit representation for 0% Black to 100% White. This range is typical for standard-dynamic range.

- **PQ Full:** The reference OETF with a high luminance range capability of 0 to 10,000 cd/m² standardized in ST 2084. The EOTF is the inverse of OETF.

The full scaling places the extremes of the nonlinear color value from zero to unity at code words 0d and 1023d in 10-bit representation and 0d and 4095d in 12-bit representation for 0% black and 100% white, respectively.

- **HLG:** The reference OETF is standardized in ARIB B67 and the reference EOTF is standardized in ITU BT.2100 at the nominal display peak luminance of 1000 nits.

- **S-Log2:** The reference OETF is defined as Sony S-Log2.

- **S-Log3:** The reference OETF is defined as Sony S-Log3.

- **S-Log3 (Live HDR):** The reference OETF and OOTF (Optical to Optical Transfer Function) are defined as Sony S-Log3 (Live HDR).

- **Log C:** The reference OETF is defined as ARRI Log C.

5. From the **Structure list, select one of the following:**

- Auto: The system selects the setting based on ST 352 VPID. If VPID is not present, YCbCr 4:2:2 10bit is selected.
- YCbCr 4:2:2 10bit
- YCbCr 4:2:2 12bit
- YCbCr 4:4:4 10bit
- RGB 4:4:4 10bit
- RGB 4:4:4 12bit

6. From the **Color Gamut list, select one of the following; the selection determines the color space of the video signal selection.**

- **Auto:** The system selects the setting based on ST 352 VPID. If ST 352 VPID is not present, Rec. 709 is selected.
- **Rec. 709:** Standard for HD
- **Rec. 2020:** Standard for 4K

7. Select **Save**.

Cursor Measurement

Make precise measurements with time and voltage cursors.

1. Select the **Cursors** button in the top right of the tile to show the time and voltage cursor options.
2. Select the **T: Off** button to display two time cursors. Select **T: On** to hide the two cursors.
3. Select and hold anywhere on the cursors to move them and mark exact times in the trace. The cursors are highlighted in yellow when moved. The timestamp of each cursor and the delta are displayed on the right side of the application.

Note: The cursor tab provides an easy way to adjust each cursor.

4. Select the **V: Off** button to display two voltage cursors. Select **V: On** to hide the two cursors.
5. Select the **V Units** button to change the voltage units between percentage (%), millivolts (mV), or code value (CV). The selected option (% , mV, or CV) is added to the button title.
6. Select and hold anywhere on the V1 or V2 cursor and drag the cursor to mark exact times in the trace.

The cursors are highlighted in yellow when moved. The voltage measurement at each cursor and the delta are displayed on the right side of the application.
7. Select the **Cursors** button to hide the T and V buttons.



Note: The time and voltage cursor positions are retained if the trace is moved horizontally or vertically, or if the gain is adjusted.

Display Mode

Change how the waveforms are displayed.

1. Select the button in the bottom left corner of the application to expand the available display options (the button label varies depending on the last option selected).
2. Select a waveform display option:
 - Select **YPbPr** to display any combination of the Y, Pb, and Pr components.
 - Select **RGB** to display any combination of the R, G, and B components.
 - Select **YRGB** to display any combination of the Y, R, G, and B components.
3. Select the components to monitor:
 - In the waveform list of components, select the letter of the component to remove it. For example, in RGB select G to remove the green component from the waveform.
 - Select the letter of a removed component to make it visible.

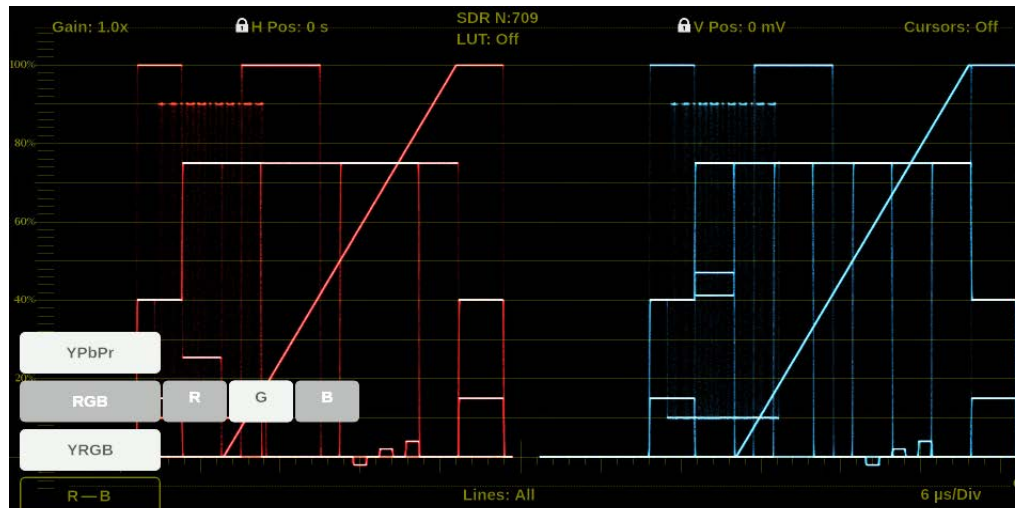

Display Format

To change the Display Style, Sweep, and Magnification of the waveform:

1. Select the button in the bottom right corner of the application to expand the available display format options (the button label varies depending on the last option selected).
2. Select the **Mag** option to set the magnification to **Best**, **1.0x**, **10.0x**, **20.0x**, or **25.0x**.
3. Select the **Display Style** option to switch between **Parade** and **Overlay**.
4. Select the **Sweep** options as needed. The options available depend on what Display Style is active.
 - When the Parade display style is active, you can select from 1 line or 1 field.
 - When Overlay display style is active, you can select from 1 line, 2 line, 1 field, or 2 field.

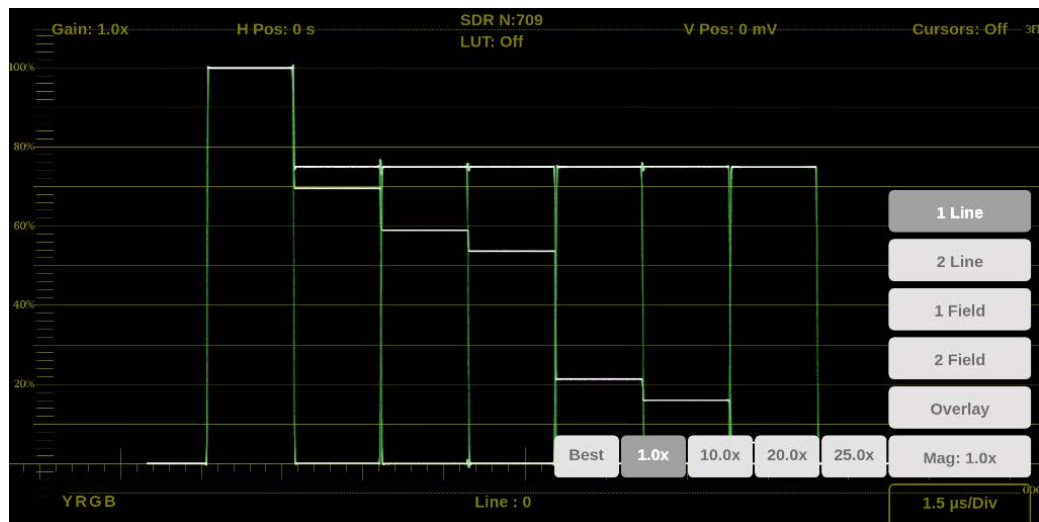

Line Select Function

Line Select allows you to select a single picture line to monitor in the display. By default, All Lines is selected and all lines are monitored.

Note: If you enable Line Select, the same line is selected in any trace display.

To turn on Line Select (and choose the line to monitor):

1. Select the **Lines** button at the bottom of the tile.
2. Select **1 Line**.
 - To scroll through lines, select the **Plus (+)** button or **Minus (-)** button.
 - To enter a specific line to monitor:
 - ◆ select **Line Sel.** and enter the line on the keypad; or
 - ◆ in the Picture application, use the line-select cursor (for active lines).

Depending on the resolution in the signal, the Line Select provides different information.

- If a signal is SD, HD, 3G:
 - ◆ the Line number is the selected line, including vertical blanking,
 - ◆ if the signal is interlaced format, the Fields readout is below the Line number,
 - ◆ the Pic Line number is next to Line; the Pic Line is the active line number, or numbers, selected.



- If a signal is UHD, 4K:
 - ◆ the Line number is the selected raster line,
 - ◆ the SDI Line is the selected line including vertical blanking,
 - ◆ the link number appears below the SDI Line.



Note: In link, the letters (A, B, C, or D) refer to the physical links. The numbers (1, 2, 3, or 4) refer to the virtual links. For example, A3/62 indicates it is physical link 1 and virtual link 3 (in a two-sample interleave, 12G transport).

Vector Application

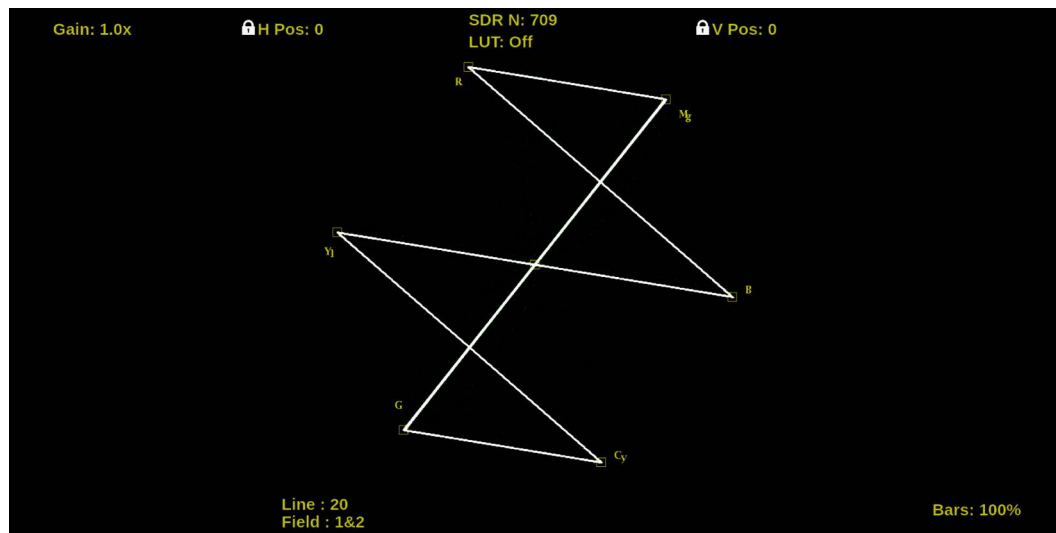
The Vector application provides an X-Y plot of color difference signals allowing the operator to match skin tones and color of ITU-R BT 709 or 2020 color space. With Option MP2-PROD, transfer function/color space conversion allows for an ITU-R BT 709 color space to verify wide color-gamut compatibility.



Configure the Vector Application

1. Select the **Tiles** icon ().
2. Select the tile with the Vector application.
3. Select the **Tile** icon ().

Note: To move the settings left or right, select the **Move** icon () in the Settings menu header.



4. In the **Bar Targets** section, select **75%** or **100%** scaling.
5. Select **IQ Axis** to turn the IQ Axis on or off.

Note: This is only for inputs configured for Rec. 709 Color Gamuts.

6. Select **SDI Compass Rose** to turn the compass in the Vector tile on or off.
7. In the **Gain** section, select the trace vector magnifications: **1.0x**, **2.0x**, **5.0x**, or **10.0x**.
8. If you set **Convert to Rec. 709** to **On**, the trace displays to convert the Gamma and Color Gamut settings for the signal to SDR Narrow and BT. 709 (requires Option MPSPD-PROD).

Note: To automatically convert settings to BT.709, set **Convert to Rec. 709** to **On**; if it is not on, you must manually change the graticule selection. (See [Configure Instrument for HDR/WCG Monitoring](#).) Convert to Rec. 709 mode is not supported for SD signals.

9. In the **Line Select** section, choose the picture lines to monitor in the display: **All Lines** or **1 Line**. If you select 1 Line, then the display shows only results for the selected line in the picture. You can use on-screen tools to select the line; see [Line Select Function](#). Alternatively, you can select the line directly on the Picture.

Vector Application On-screen Tools

You can change the gain, horizontal position, vertical position, gamma LUT, selected line, and bar targets without opening the Vector Settings menu through on-screen tools. Select the button for the setting you want to adjust. The available tools are on the top and bottom of the display and are highlighted for a few seconds when the application is first opened or if you select anywhere in the middle of the application tile.

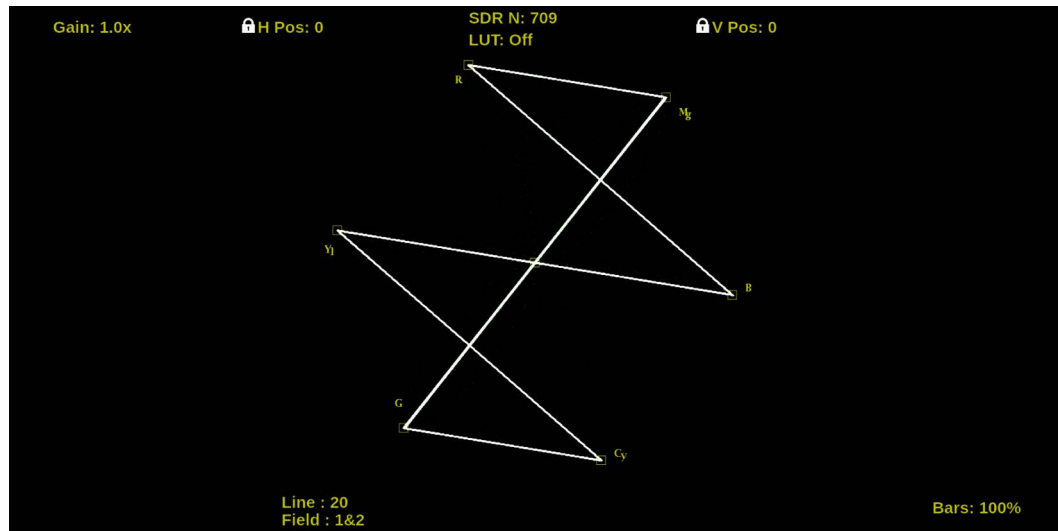

Gain

To increase or decrease the magnification of the trace display:

1. Select **Gain** (the number varies) in the trace tile to open the magnification menu.
2. Select a preset magnification for fixed gain. On a touchscreen, you can use a pinch gesture to change the scale of the trace for large increments.
3. Select **VAR:** (On or Off) to turn the variable gain on or off.

Variable gain (VAR: On) allows you to change the gain factor (Var Gain) in 0.01 increments.

4. Select the **Plus (+)** button or **Minus (-)** button under Var Gain as needed to make detailed adjustments to the variable gain.

The limits of the variable gain change depending on the gain factor you select.

- 1.0x has a range of 0.25x to 4.00x gain.
- 2.0x has a range of 0.50x to 8.00x gain.
- 5.0x has a range of 1.25x to 20.00x gain.
- 10.0x has a range of 2.50x to 40.00x gain.

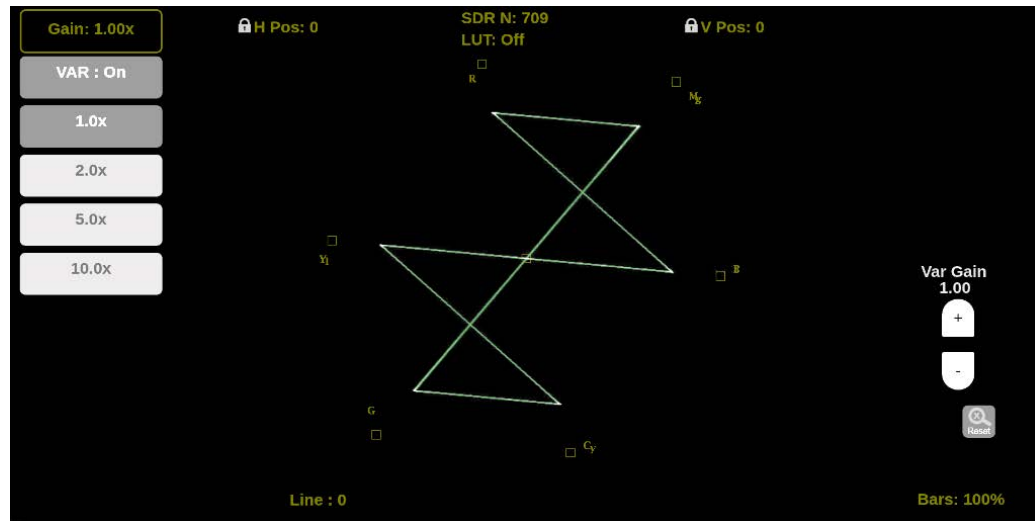

Select the **Reset** icon () to remove variable gain adjustments and reset the gain to 1.00 and 1.0x.

Horizontal and Vertical Position

To adjust the position of the trace display:

1. Select **H Pos** to allow adjustment of the horizontal trace.
 - Select-and-drag to move the trace on the touchscreen. This method can be performed without using the button.
 - Use a mouse scroll wheel to move the trace.
 - For small changes, select the **Plus (+)** button or **Minus (-)** button to adjust the horizontal position.
 - Select the **Reset** icon () to reset the horizontal position adjustment to default.

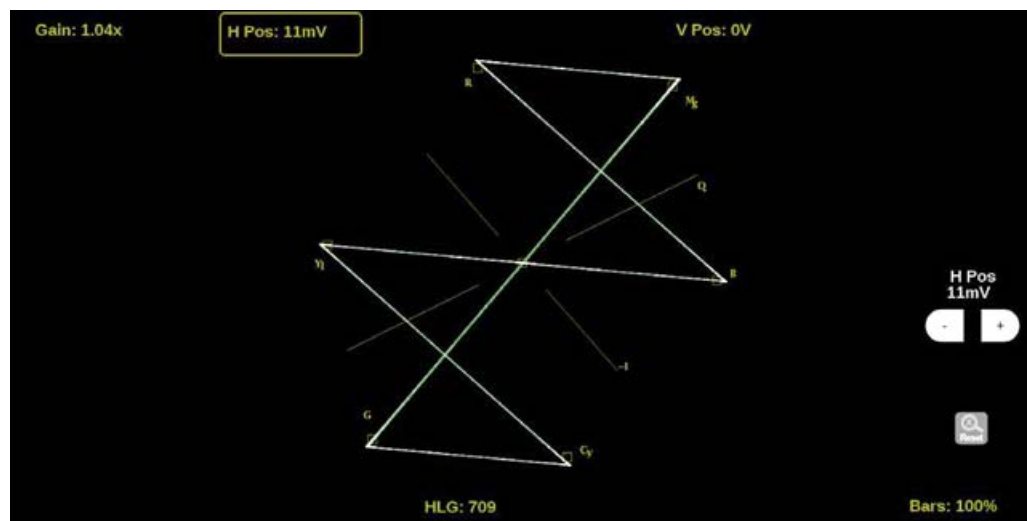

2. Select V Pos to allow adjustment of the vertical trace.

- Select-and-drag to move the trace on the touchscreen. This method can be performed without using the button.
- Use a mouse scroll wheel to move the trace.
- For small changes, select the **Plus (+)** button or **Minus (-)** button to adjust the horizontal position.
- Select the **Reset** icon () to reset the vertical position adjustment to default.

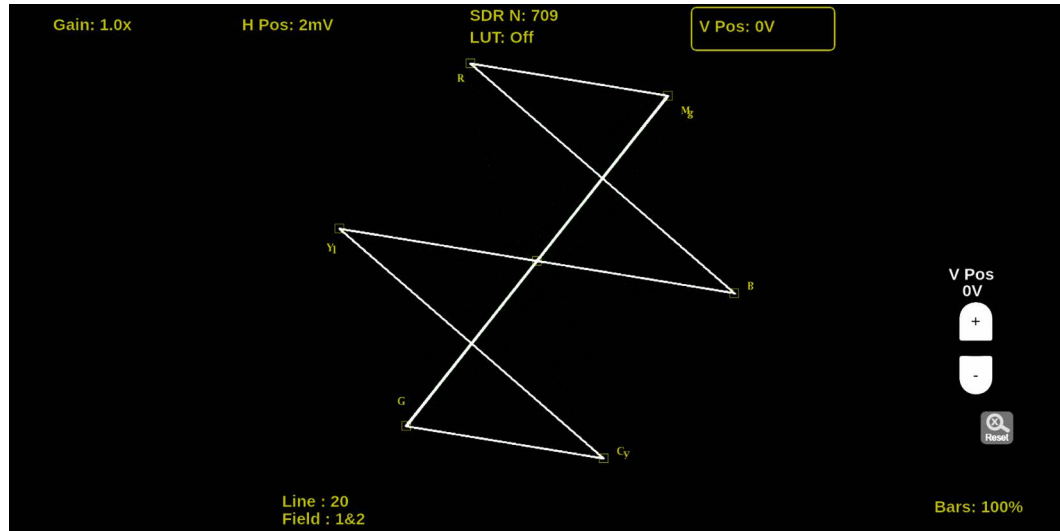

Gamma LUT

To turn the Gamma LUT on or off:

1. Select the **LUT** button (other elements in the button are variable depending on the options selected) in the upper middle of the display.
2. Select the lower **LUT:** button to set the Gamma LUT on or off.

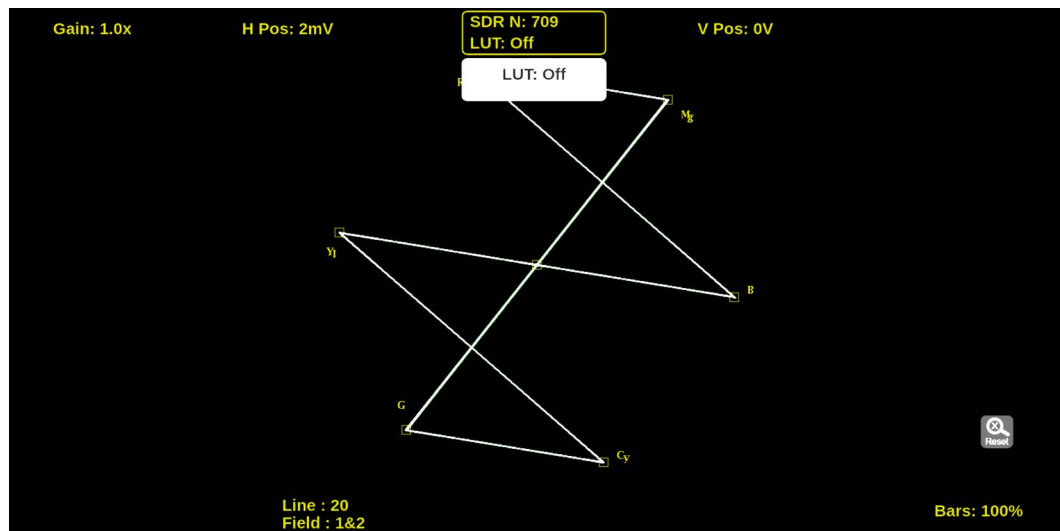

To change the gamma curve and color gamut (displayed in the LUT button):

1. Select the **Settings** icon ().
2. Select **Inputs** and select the input being used.
3. Select **SDI** and **VIDEO**.
4. From the **Gamma Curve** list, select one of the following; the selection characterizes the video signal on each virtual input.
 - **Auto**: The system selects the setting based on ST 352 VPID. If 352 VPID is not present, SDR Narrow is selected.
 - **SDR Narrow**: The reference OETF (Optical to Electrical Transfer Function) is defined in ITU-R BT.709 with gamma of 0.45 and the reference EOTF is defined in ITU-R BT.1886 with gamma of 2.4.

The Narrow scaling places the extremes of the nonlinear color value from zero to unity at code words 40 hex (64 dec) and 3AC hex (940 dec) in a 10-bit representation for 0% Black to 100% White. This range is typical for standard-dynamic range.
 - **SDR Full**: The reference OETF is defined in ITU-R BT.709 with gamma of 0.45 and the reference EOTF (Electrical to Optical Transfer Function) is defined in ITU-R BT.1886 with gamma of 2.4.

The full scaling places the extremes of the nonlinear color value from zero to unity at code words 0d and 1023d in 10-bit representation and 0d and 4095d in 12-bit representation for 0% black and 100% white, respectively.
 - **PQ Narrow**: The reference OETF with a high luminance range capability of 0 to 10,000 cd/m² standardized in ST 2084. The EOTF is the inverse of OETF.

The narrow scaling places the extremes of the nonlinear color value from zero to unity at code words 40 hex (64 dec) and 3AC hex (940 dec) in a 10-bit representation for 0% Black to 100% White. This range is typical for standard-dynamic range.
 - **PQ Full**: The reference OETF with a high luminance range capability of 0 to 10,000 cd/m² standardized in ST 2084. The EOTF is the inverse of OETF.

The full scaling places the extremes of the nonlinear color value from zero to unity at code words 0d and 1023d in 10-bit representation and 0d and 4095d in 12-bit representation for 0% black and 100% white, respectively.
 - **HLG**: The reference OETF is standardized in ARIB B67 and the reference EOTF is standardized in ITU BT.2100 at the nominal display peak luminance of 1000 nits.
 - **S-Log2**: The reference OETF is defined as Sony S-Log2.
 - **S-Log3**: The reference OETF is defined as Sony S-Log3.
 - **S-Log3 (Live HDR)**: The reference OETF and OOTF (Optical to Optical Transfer Function) are defined as Sony S-Log3 (Live HDR).
 - **Log C**: The reference OETF is defined as ARRI Log C.
5. From the **Structure** list, select one of the following:
 - Auto: The system selects the setting based on ST 352 VPID. If VPID is not present, YCbCr 4:2:2 10bit is selected.

- YCbCr 4:2:2 10bit
- YCbCr 4:2:2 12bit
- YCbCr 4:4:4 10bit
- RGB 4:4:4 10bit
- RGB 4:4:4 12bit

6. From the **Color Gamut** list, select one of the following; the selection determines the color space of the video signal selection.

- **Auto**: The system selects the setting based on ST 352 VPID. If ST 352 VPID is not present, Rec. 709 is selected.
- **Rec. 709**: Standard for HD
- **Rec. 2020**: Standard for 4K

7. Select **Save**.

Bar Targets

To change the scaling of the Vector display.

1. Select the **Bars** button in the bottom right corner of the application to expand the available options.
2. Select either **75%** or **100%** scaling.

Line Select Function

You can select a single picture line to monitor in the display. By default, All Lines is selected and all lines are monitored.

Note: If you enable line select, the same line is selected in any trace display.

To turn on Line Select (and choose the line to monitor):

1. Select the **Lines** button at the bottom of the tile.
2. Select 1 Line.
 - To scroll through lines, select the **Plus (+)** button or **Minus (-)** button.
 - To enter a specific line to monitor:
 - ◆ select **Line Sel.** and enter the line on the keypad; or
 - ◆ in the Picture application, use the line-select cursor (for active lines).

Depending on the resolution in the signal, the Line Select provides different information.

- If a signal is SD, HD, 3G:
 - ◆ the Line number is the selected line, including vertical blanking,
 - ◆ if the signal is interlaced format, the Fields readout is below the Line number,
 - ◆ the Pic Line number is next to Line; the Pic Line is the active line number, or numbers, selected.

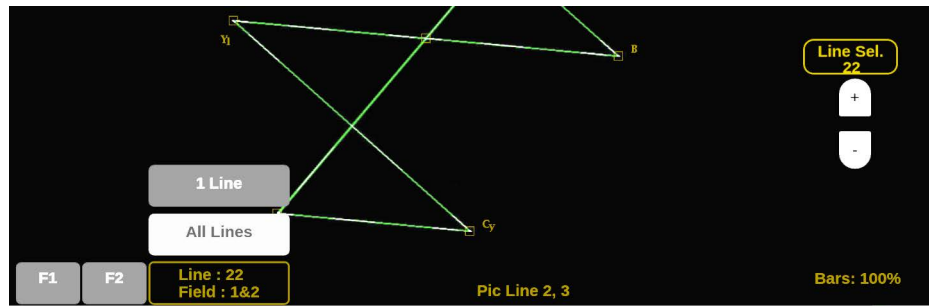

- If a signal is UHD, 4K:
 - ◆ the Line number is the selected raster line,
 - ◆ the SDI Line is the selected line including vertical blanking,
 - ◆ the link number appears below the SDI Line.



Note: In link, the letters (A-D) refer to the physical links. The numbers (1-4) refer to the virtual links. For example, A3/62 indicates it is physical link 1 and virtual link 3 (in a two-sample interleave, 12G transport).

Lightning Application

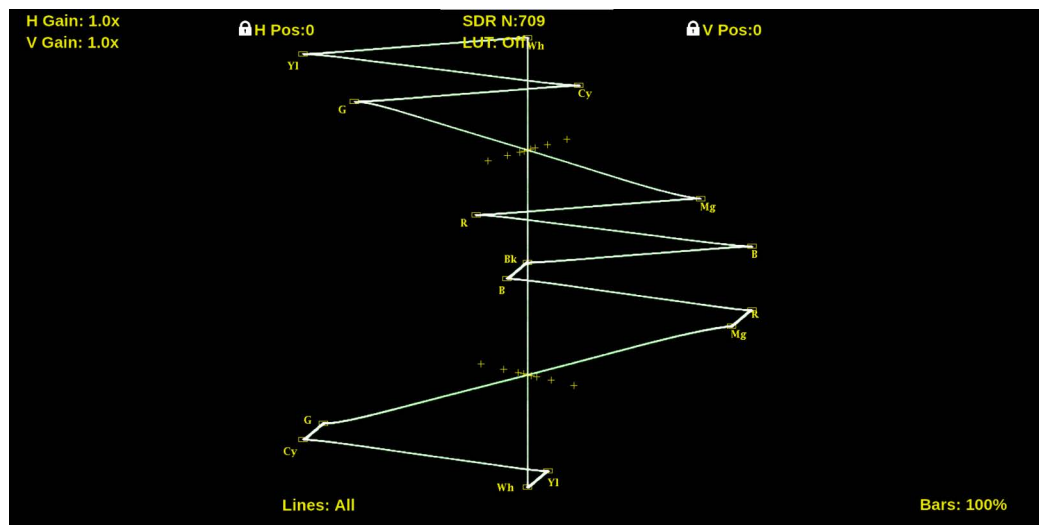
The Lightning application shows luma and chroma amplitudes and helps verify component timing using a color-bar signal. Using a test signal in component format, this display helps make precise, accurate measurements of inter-channel amplitude and timing.



Configure the Lightning Application

1. Select the **Tiles** icon ().
2. Select the tile with the Lightning application.
3. Select the **Tile** icon ().

Note: To move the settings left or right, select the **Move** icon () in the Settings menu header.



4. In the **Bar Targets** section, select **75%** or **100%** scaling.
5. In the **V Gain** section, select the vertical gain: **1.0x**, **2.0x**, **5.0x**, or **10.0x** magnification.
6. In the **H Gain** section, select the horizontal gain: **1.0x**, **2.0x**, **5.0x**, or **10.0x** magnification.
7. Set **Convert to Rec. 709** to **On** to allow trace displays to convert the Gamma and Color Gamut settings for the signal to SDR Narrow and BT.709 (requires Option MP2-PROD).

Note: To automatically convert settings to BT.709, set **Convert to Rec. 709** to **On**; if it is not on, you must manually change the graticule selection. see [Configure Instrument for HDR/WCG Monitoring](#). Convert to Rec. 709 mode is not supported for SD signals.

8. Set **Line Select** to **On** to select 1 Line or **Off** to select All Lines. When Line Select is set to On (Line Select: Line 1), the display shows only results for the selected line in the picture. You can use on-screen tools to select the line; see [Line Select Function](#). Alternatively, you can select the line directly on the Picture.

Lightning Application On-screen Tools

You can change the horizontal gain, vertical gain, horizontal position, vertical position, gamma LUT, selected line, and bar targets without opening the Lightning Settings menu through on-screen tools. Select the button for the setting you want to adjust. All the available tools are located on the top and bottom of the display and are highlighted

for a few seconds when the application is first opened or if you select anywhere in the middle of the application tile.

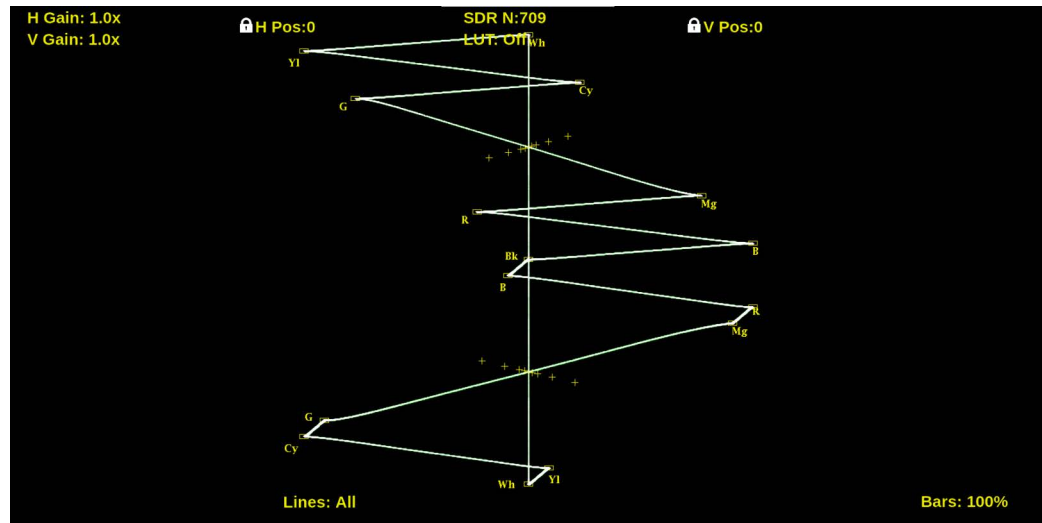

Horizontal and Vertical Gain

To increase or decrease the magnification of the horizontal and vertical trace displays:

1. Select the button at the top-left to open the available options menu.
2. Select a preset magnification for fixed horizontal and vertical gain using the H Gain and V Gain options.
3. Select Variable Gain; select VAR: Off to VAR: H or VAR: V.
 - Select **VAR: H** to change the horizontal gain in increments.
 - Select **VAR: V** to change the vertical gain. Variable gain allows you flexibility in changing the gain factor between 0.5x to 20.0x.
 - Select **Off** to shut off both gain options.

The limits of the variable gain change depending on the gain factor you select.

- ◆ 1.0x has a range of 0.25x to 2.00x gain.
- ◆ 2.0x has a range of 0.50x to 4.00x gain.
- ◆ 5.0x has a range of 1.25x to 10.00x gain.
- ◆ 10.0x has a range of 2.50x to 20.00x gain

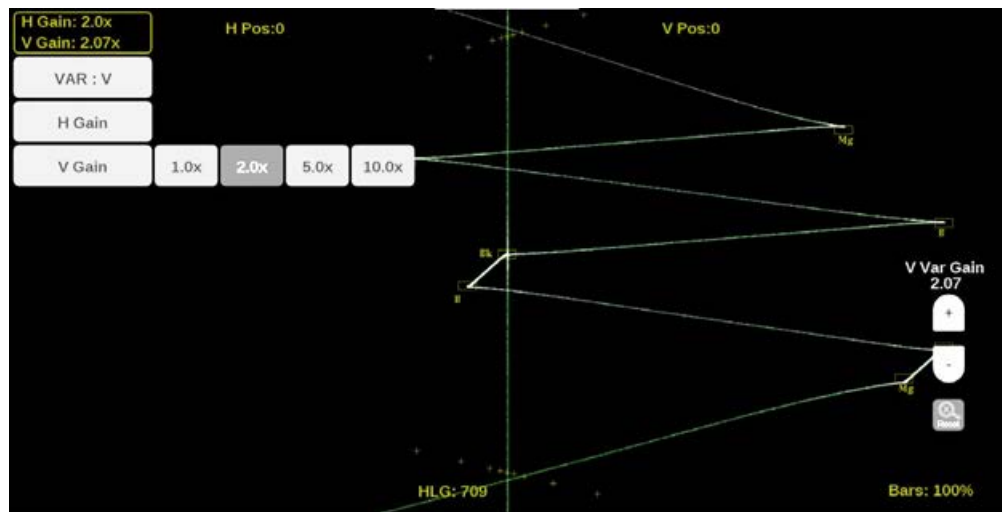
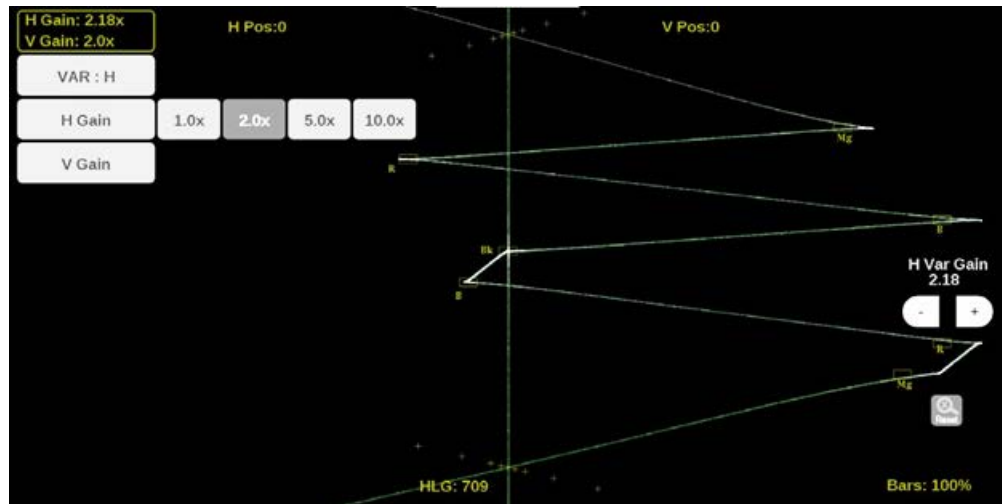

To adjust the gain:

- With a touchscreen, use a pinch gesture to change the scale of the trace for large incremental changes.
- For incremental adjustments, select the **Plus (+)** button or **Minus (-)** button.
- Use the scroll wheel on a mouse to adjust the variable gain.
- Select the **Reset** icon () to remove variable gain adjustments.

Horizontal and Vertical Position

To adjust the position of the trace display:

1. Select the **H Pos** button to allow adjustment of the horizontal trace.
 - Select-and-drag to move the trace on the touchscreen. This method can be performed without using the button.

- Use a mouse scroll wheel to move the trace.
- For incremental adjustments, select the **Plus (+)** button or **Minus (-)** button.
- Select the **Reset** icon () to change the horizontal position adjustment to default.

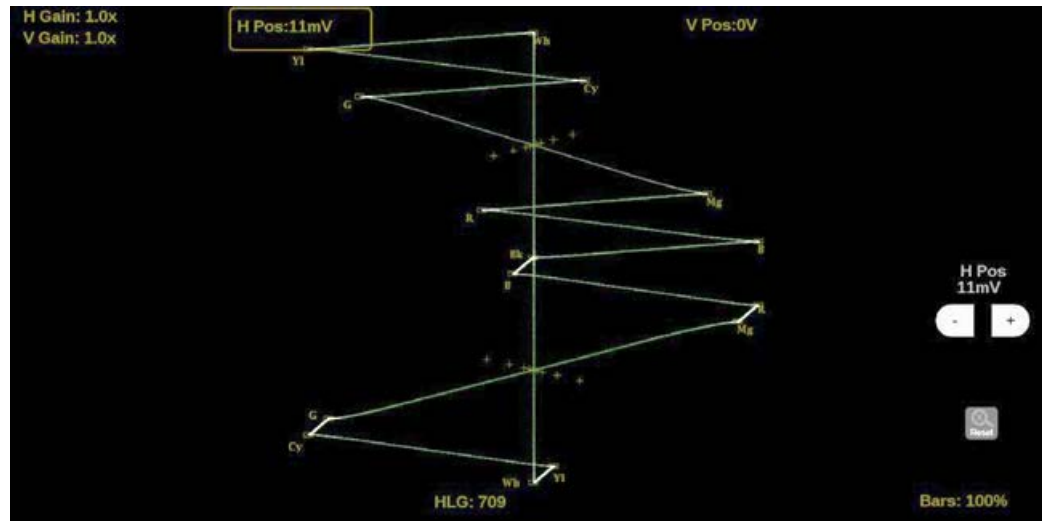

2. Select the **V Pos** button to allow adjustment of the vertical trace.
 - Select-and-drag to move the trace on the touchscreen. This method can be performed without using the button.
 - Use a mouse scroll wheel to move the trace.
 - For incremental adjustments, use the **Plus (+)** button or **Minus (-)** button.
 - Select the **Reset** icon () to reset the vertical position adjustment to default.

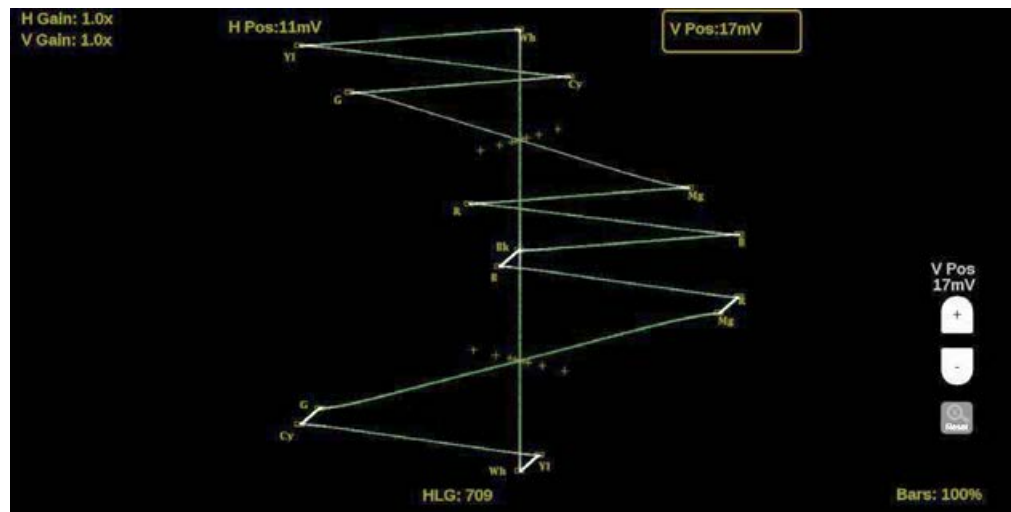

Gamma LUT

Turn the Gamma LUT on or off:

1. Select the **LUT** button (other elements in the button are variable depending on the options selected) in the upper middle of the tile.
2. Select the lower **LUT:** button to set the Gamma LUT on or off.

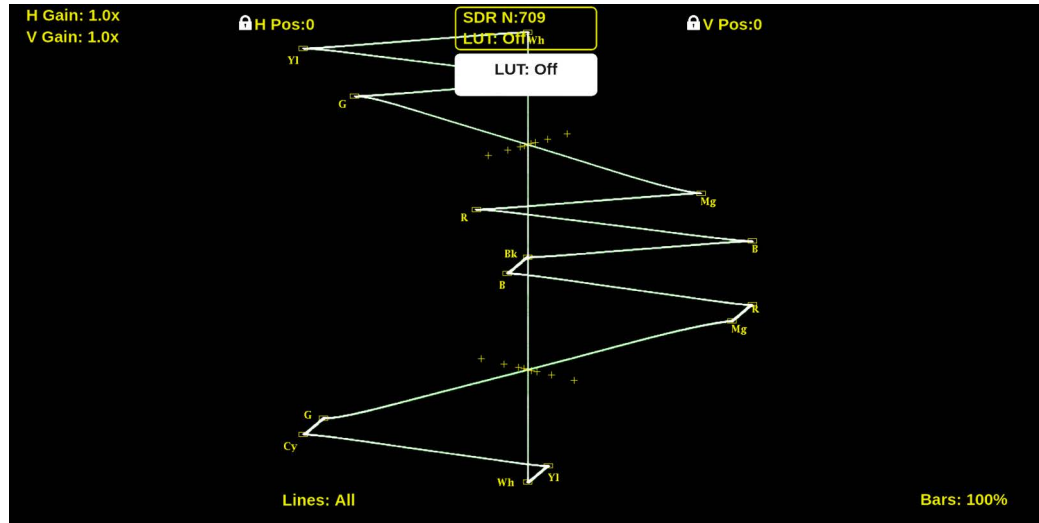

To change the gamma curve and color gamut (displayed in the LUT button):

1. Select the **Settings** icon (⚙️).
2. Select **Inputs** and select the input being used.
3. Select **SDI** and then select **VIDEO**.
4. Select the **Gamma Curve** menu and choose the setting. The selection characterizes the video signal on each virtual input.
 - **Auto:** The system selects the setting based on ST 352 VPID. If 352 VPID is not present, SDR Narrow is selected.
 - **SDR Narrow:** The reference OETF (Optical to Electrical Transfer Function) is defined in ITU-R BT.709 with gamma of 0.45 and the reference EOTF (Electrical to Optical Transfer Function) is defined in ITU-R BT.1886 with gamma of 2.4.
The Narrow scaling places the extremes of the nonlinear color value from zero to unity at code words 40 hex (64 dec) and 3AC hex (940 dec) in a 10-bit representation for 0% Black to 100% White. This range is typical for standard-dynamic range.
 - **SDR Full:** The reference OETF is defined in ITU-R BT.709 with gamma of 0.45 and the reference EOTF is defined in ITU-R BT.1886 with gamma of 2.4.
The full scaling places the extremes of the nonlinear color value from zero to unity at code words 0d and 1023d in 10-bit representation and 0d and 4095d in 12-bit representation for 0% black and 100% white, respectively.

- **PQ Narrow:** The reference OETF with a high luminance range capability of 0 to 10,000 cd/m² standardized in ST 2084. The EOTF is the inverse of OETF.

The narrow Scaling places the extremes of the nonlinear color value from zero to unity at code words 40 hex (64 dec) and 3AC hex (940 dec) in a 10-bit representation for 0% Black to 100% White. This range is typical for standard-dynamic range.

- **PQ Full:** The reference OETF with a high luminance range capability of 0 to 10,000 cd/m² standardized in ST 2084. The EOTF is the inverse of OETF.

The Full scaling places the extremes of the nonlinear color value from zero to unity at code words 0d and 1023d in 10-bit representation and 0d and 4095d in 12-bit representation for 0% black and 100% white, respectively.

- **HLG:** The reference OETF is standardized in ARIB B67 and the reference EOTF is standardized in ITU BT.2100 at the nominal display peak luminance of 1000 nits.
- **S-Log2:** The reference OETF is defined as Sony S-Log2.
- **S-Log3:** The reference OETF is defined as Sony S-Log3.
- **S-Log3 (Live HDR):** The reference OETF is defined as Sony S-Log3.
- **Log C:** The reference OETF is defined as ARRI Log C.

5. Select **Color Gamut** settings in the menu. The selection is the color space of the video signal.

- **Auto:** The system selects the setting based on ST 352 VPID. If 352 VPID is not present, Rec. 709 is selected.
- **Rec. 709:** Standard for HD.
- **Rec. 2020:** Standard for 4K.

6. Select **Save**.

Bar Targets

To change the scaling of the Lightning Display.

1. Select **Bars** in the bottom-right corner of the application to expand the available options.
2. Select **75%** or **100%** scaling.

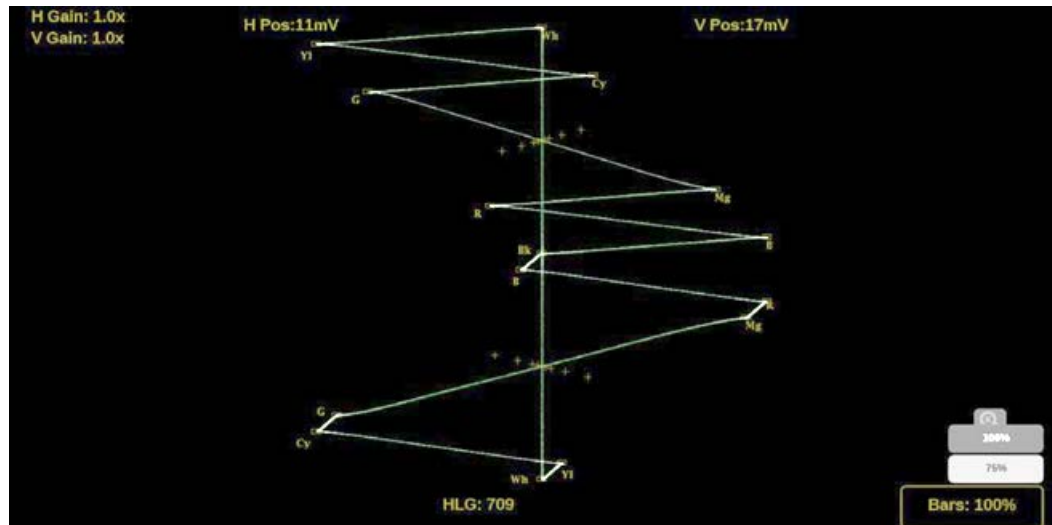

Line Select Function

You can select a single picture line to monitor in the display. By default, All Lines is selected and all lines are monitored.

Note: If you enable line select, the same line is selected in any trace display.

To turn on Line Select (and choose the line to monitor):

1. Select the **Lines** button at the bottom of the tile.
2. Select **1 Line**.
 - To scroll through lines, use the **Plus (+)** button or **Minus (-)** button.
 - To enter a specific line to monitor:
 - ◆ select **Line Sel.** and enter the line on the keypad; or
 - ◆ in the Picture application, use the line-select cursor (for active lines).

Depending on the resolution in the signal, the Line Select provides different information.

- If a signal is SD, HD, or 3G:
 - ◆ the Line number is the selected line, including vertical blanking,
 - ◆ if the signal is interlaced format, the Fields readout is below the Line number,
 - ◆ the Pic Line number is next to Line; the Pic Line is the active line number, or numbers, selected.

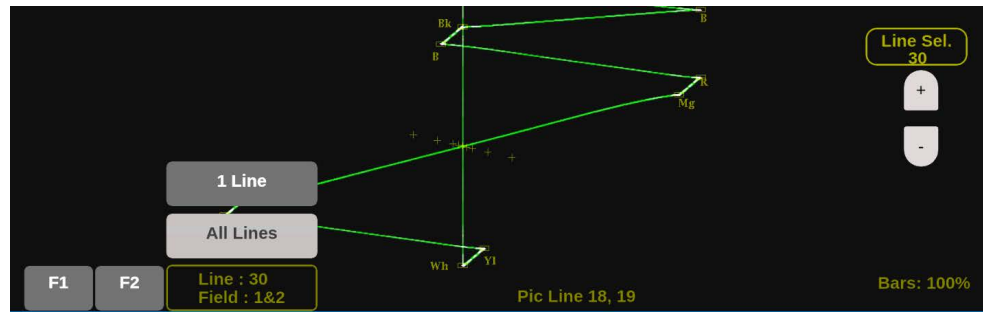

- If a signal is UHD or 4K:
 - ◆ the Line number is the selected raster line,
 - ◆ the SDI Line is the selected line including vertical blanking,
 - ◆ the link number appears below the SDI Line.



In link, the letters (A-D) refer to the physical links. The numbers (1-4) refer to the virtual links. For example, A3/62 indicates it is physical link 1 and virtual link 3 (in a two-sample interleave, 12G transport).

Diamond Application

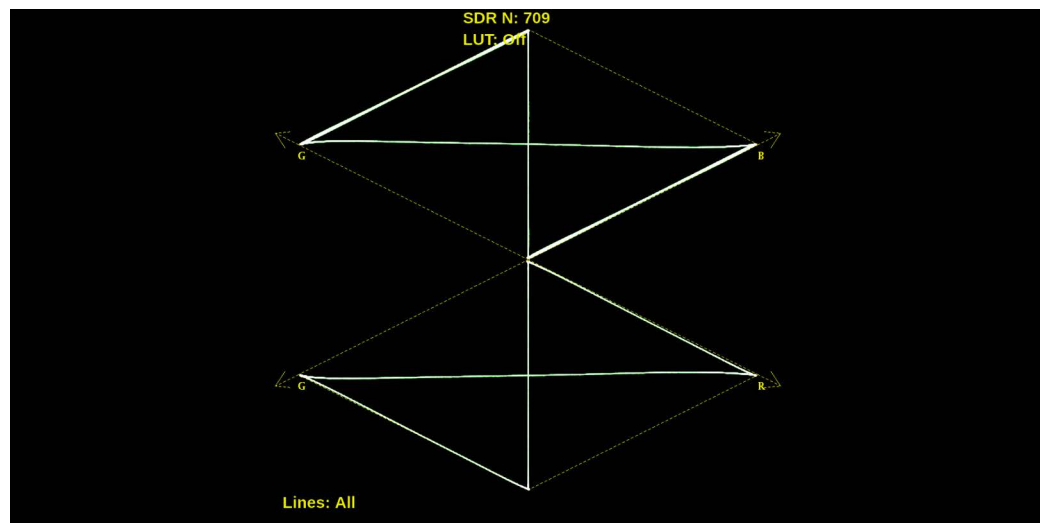
The Diamond application provides a tool for white and black balancing at camera setup and for color gamut adjustment at color editing and QC. For additional information on how to use the Diamond application, refer to the [Checking Gamut](#) section.



Configure the Diamond Application

1. Select the **Tiles** icon ().
2. Select the tile with the Diamond application.
3. Select the **Tile** icon ().

Note: To move the settings left or right, select the **Move** icon (↔) in the Settings menu header.

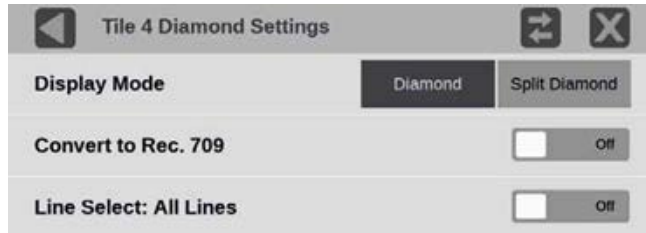

4. In the **Display Mode** section, select an option:

- **Diamond:** The normal Diamond display shows Gamut violations of the SDI input if translated to RGB color space.
- **Split Diamond:** The split Diamond display offsets the two halves of the Diamond to better see negative RGB Gamut errors.

5. Set **Convert to Rec. 709** to **On** to allow the trace displays to convert the Gamma and Color Gamut settings for the signal to SDR Narrow and BT. 709 (requires Option MPSPD-PROD).

Note: Convert to Rec. 709 auto converts to BT.709, otherwise the graticule selection must be manually changed (see [Configure Instrument for HDR/WCG Monitoring](#)). Convert to Rec. 709 mode is not supported for SD signals.

6. Set **Line Select** to **On** to select 1 Line or **Off** to select All Lines. When Line Select is set to On (Line Select: Line 1), the display shows only results for the selected line in the picture. You can use on-screen tools to select the line; see [Line Select Function](#). Alternatively, you can select the line directly on the Picture.

Checking Gamut

The diamond display effectively shows how the R, G, and B signals relate. The Diamond display is a good tool for detecting gamut errors.

To form the diamond display, the instrument converts the Y, Pb, and Pr components recovered from the serial signal to R, G, and B. To predictably display all three components, they must lie between peak white, 700 mV, and black, 0 V.

For a signal to be in gamut, all signal vectors must lie within the G-B and G-R diamonds. Conversely, if a signal vector extends outside the diamond, it is out of gamut. The direction of an excursion out of gamut indicates which signal is excessive. Errors in green amplitude affect both diamonds equally, while blue amplitude errors affect only the top diamond and red errors affect only the bottom diamond.

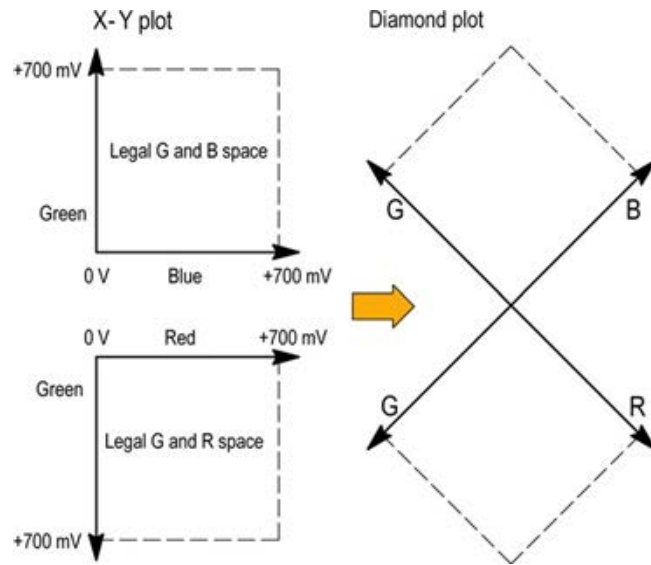

Compare the signal to the display to determine out-of-gamut components. Be aware of these details:

- The intensity of a vector indicates its duration.
- A momentary out-of-gamut condition appears as a faint trace. Long duration violations show as a bright trace.

When evaluating out-of-gamut components, consider:

- Example A:
R - Ok
G > 700 mV
B - Ok
- Example B:
R - Ok
G - Ok
B > 700 mV
- Example C:
R - Ok
G - Ok, 350 mV
B < 0 mV

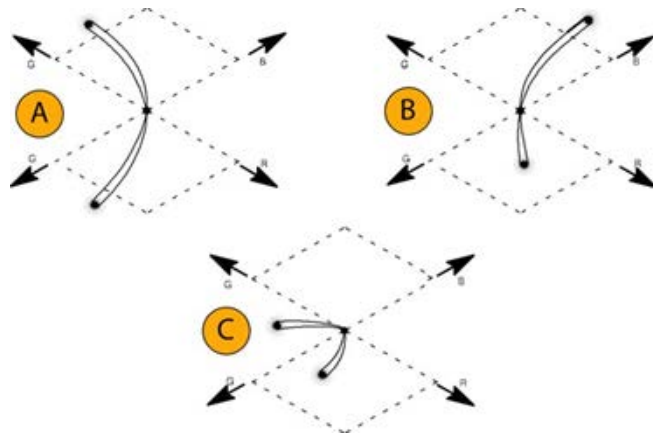

Note: Bending of the transitions indicates timing delays. When a color bar signal is applied, the vertical axis becomes an indicator of delay errors. Monochrome signals appear as vertical lines. Nonlinear component processing, such as from a gamma corrector that alters white balance, can cause deviations along the vertical axis.

Diamond Application On-screen Tools

You can change the gamma LUT and selected line—without opening the Diamond Settings menu—through on-screen tools. Select the button for the setting you want to adjust. All the available tools are located on the top and bottom of the display and are highlighted for a few seconds when the application is first opened or if you select anywhere in the middle of the application tile.

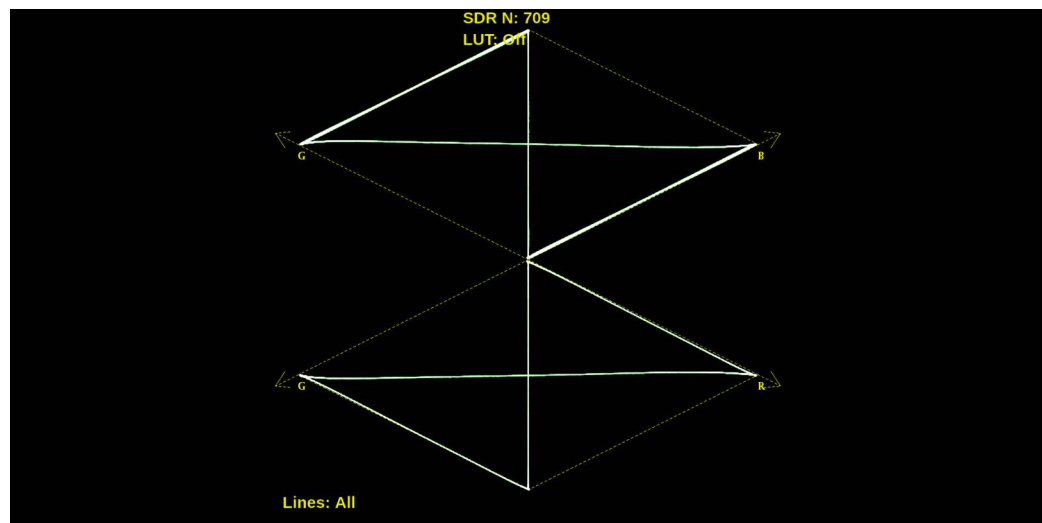

Gamma LUT

Turn the Gamma LUT on or off:

1. Select the **LUT** button (other elements in the button are variable depending on the options selected) in the upper middle of the tile.
2. Select the lower **LUT:** button to set the Gamma LUT on or off.

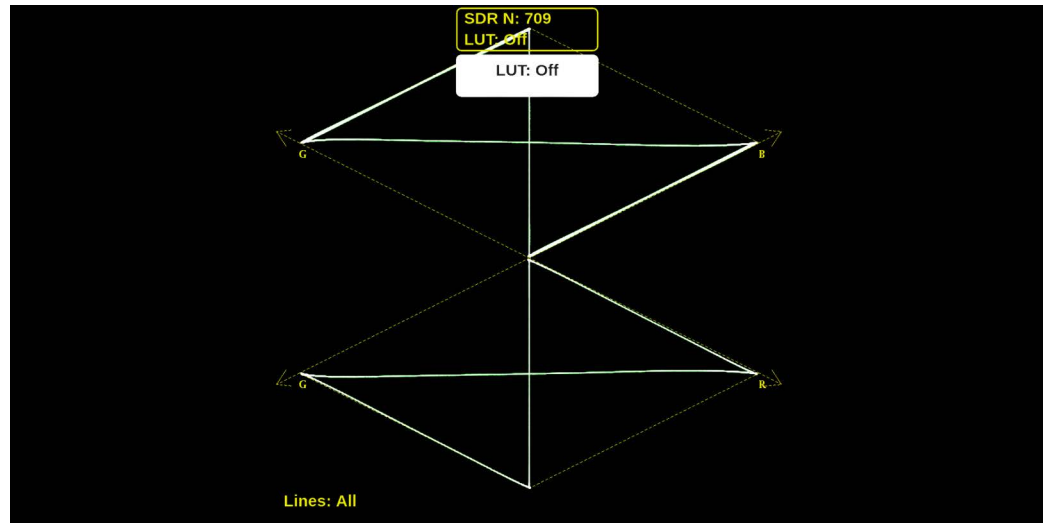

To change the gamma curve and color gamut (displayed in the LUT button):

1. Select the **Settings** icon (⚙️).
2. Select **Inputs** and select the input being used.
3. Select **SDI** and **VIDEO**.
4. From the **Gamma Curve** list, select one of the following; the selection characterizes the video signal on each virtual input.

- **Auto:** The system selects the setting based on ST 352 VPID. If 352 VPID is not present, SDR Narrow is selected.
- **SDR Narrow:** The reference OETF (Optical to Electrical Transfer Function) is defined in ITU-R BT.709 with gamma of 0.45 and the reference EOTF is defined in ITU-R BT.1886 with gamma of 2.4.

The Narrow scaling places the extremes of the nonlinear color value from zero to unity at code words 40 hex (64 dec) and 3AC hex (940 dec) in a 10-bit representation for 0% Black to 100% White. This range is typical for standard-dynamic range.

- **SDR Full:** The reference OETF is defined in ITU-R BT.709 with gamma of 0.45 and the reference EOTF (Electrical to Optical Transfer Function) is defined in ITU-R BT.1886 with gamma of 2.4.

The full scaling places the extremes of the nonlinear color value from zero to unity at code words 0d and 1023d in 10-bit representation and 0d and 4095d in 12-bit representation for 0% black and 100% white, respectively.

- **PQ Narrow:** The reference OETF with a high luminance range capability of 0 to 10,000 cd/m² standardized in ST 2084. The EOTF is the inverse of OETF.

The narrow scaling places the extremes of the nonlinear color value from zero to unity at code words 40 hex (64 dec) and 3AC hex (940 dec) in a 10-bit representation for 0% Black to 100% White. This range is typical for standard-dynamic range.

- **PQ Full:** The reference OETF with a high luminance range capability of 0 to 10,000 cd/m² standardized in ST 2084. The EOTF is the inverse of OETF.

The full scaling places the extremes of the nonlinear color value from zero to unity at code words 0d and 1023d in 10-bit representation and 0d and 4095d in 12-bit representation for 0% black and 100% white, respectively.

- **HLG:** The reference OETF is standardized in ARIB B67 and the reference EOTF is standardized in ITU BT.2100 at the nominal display peak luminance of 1000 nits.
- **S-Log2:** The reference OETF is defined as Sony S-Log2.
- **S-Log3:** The reference OETF is defined as Sony S-Log3.
- **S-Log3 (Live HDR):** The reference OETF and OOTF (Optical to Optical Transfer Function) are defined as Sony S-Log3 (Live HDR).
- **Log C:** The reference OETF is defined as ARRI Log C.

5. From the **Structure** list, select one of the following:

- Auto: The system selects the setting based on ST 352 VPID. If VPID is not present, YCbCr 4:2:2 10bit is selected.
- YCbCr 4:2:2 10bit
- YCbCr 4:2:2 12bit
- YCbCr 4:4:4 10bit
- RGB 4:4:4 10bit
- RGB 4:4:4 12bit

6. From the **Color Gamut** list, select one of the following; the selection determines the color space of the video signal selection.

- **Auto:** The system selects the setting based on ST 352 VPID. If ST 352 VPID is not present, Rec. 709 is selected.
- **Rec. 709:** Standard for HD
- **Rec. 2020:** Standard for 4K

7. Select **Save**.

Line Select Function

You can select a single picture line to monitor in the display. By default, All Lines is selected and all lines are monitored.

Note: If you enable line select, the same line is selected in any trace display.

To turn on Line Select (and choose the line to monitor):

1. Select the **Lines** button at the bottom of the tile.
2. Select **1 Line**.
 - To scroll through lines, select the **Plus (+)** button or **Minus (-)** button.
 - To enter a specific line to monitor:
 - ◆ select **Line Sel.** and enter the line on the keypad,
 - or
 - ◆ in the Picture application, use the line-select cursor (for active lines).

Depending on the resolution in the signal, the Line Select provides different information.

- If a signal is SD, HD, or 3G:
 - ◆ the Line number is the selected line, including vertical blanking;
 - ◆ if the signal is interlaced format, the Fields readout is below the Line number;
 - ◆ the Pic Line number is next to Line; the Pic Line is the active line number, or numbers, selected.

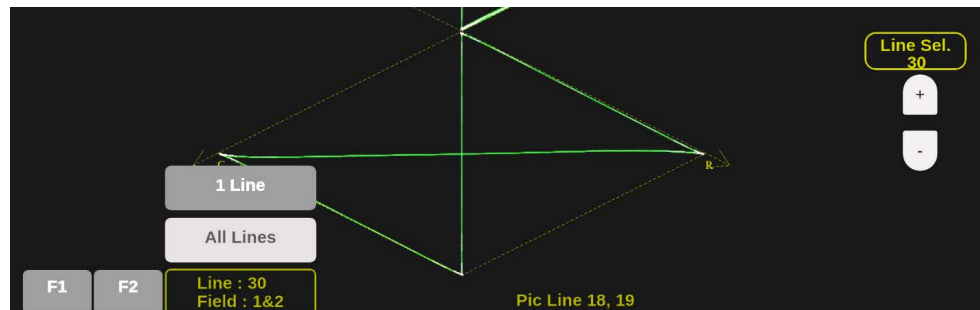

- If a signal is UHD or 4K:
 - ◆ the Line number is the selected raster line,
 - ◆ the SDI Line is the selected line including vertical blanking,
 - ◆ the link number appears below the SDI Line.

Note: In link, the letters (A-D) refer to the physical links. The numbers (1-4) refer to the virtual links. For example, A3/62 indicates it is physical link 1 and virtual link 3 (in a two-sample interleave, 12G transport).

CIE Application

The CIE application shows video data as it is plotted in a 1931 or 1976 CIE diagram. CIE diagrams are used to check the chromaticity of the video signal and determine compliance to the standard color Gamut limits shown on the CIE diagram. In addition to the BT.2020, P3, and Rec. 709 limits shown, the D65 white point is also indicated.

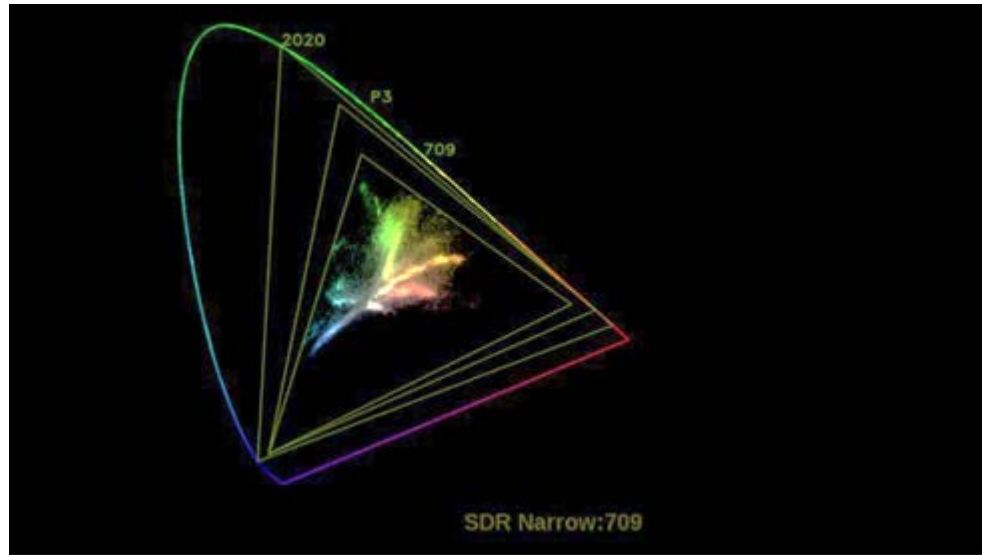

Configure the CIE Application

1. Select the **Tiles** icon (🧩).
2. Select the tile with the CIE application.
3. Select the **Tile** icon (⚙️).

Note: To move the settings left or right, select the **Move** icon (↔️) in the Settings menu header.



4. In the **Color Space** section, select **CIE 1931** or **CIE 1976**.
5. In the **Trace Appearance** section, select how video data is plotted on the CIE display:
 - **Monochrome:** The plotted video data is gray.
 - **Color:** The plotted video data is colored with the corresponding CIE diagram colors.

- Set **Line Select** to **On** to select 1 Line or **Off** to select All Lines. When Line Select is set to On (Line Select: Line 1), the display shows only results for the selected line in the picture. You can use on-screen tools to select the line; see [Line Select Function](#). Alternatively, you can select the line directly on the Picture.

CIE Application Line Select Function

You can select a single picture line to monitor in the display. By default, All Lines is selected and all lines are monitored.

Note: If you enable line select, the same line is selected in any trace display.

To turn on Line Select (and choose the line to monitor):

- Select the **Lines** button at the bottom of the tile.
- Select **1 Line**.
 - To scroll through lines, use the **Plus (+)** button or **Minus (-)** button.
 - To enter a specific line to monitor:
 - ◆ select **Line Sel.** and enter the line on the keypad; or
 - ◆ in the Picture application, use the line-select cursor (for active lines).

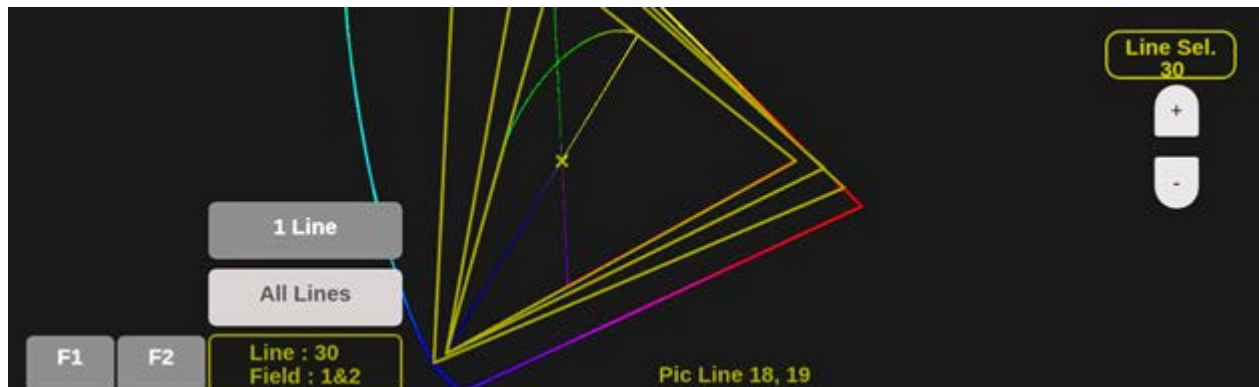

Depending on the resolution in the signal, the Line Select provides different information.

- If a signal is SD, HD, 3G:
 - ◆ the Line number is the selected line, including vertical blanking;
 - ◆ if the signal is interlaced format, the Fields readout is below the Line number;
 - ◆ the Pic Line number is next to Line; the Pic Line is the active line number, or numbers, selected.
- If a signal is UHD, 4K:
 - ◆ the Line number is the selected raster line,
 - ◆ the SDI Line is the selected line including vertical blanking,
 - ◆ the link number appears below the SDI Line.

In link, the letters (A-D) refer to the physical links. The numbers (1-4) refer to the virtual links. For example, A3/62 indicates it is physical link 1 and virtual link 3 (in a two-sample interleave, 12G transport).

Luma Qualified CIE

Luma Qualified CIE Settings allow you to configure luma limits to constrain the trace within the CIE display. This can be useful for editors and colorists to help isolate the image within a specific luma range so that the operator can easily adjust the trace to keep within specific limits.

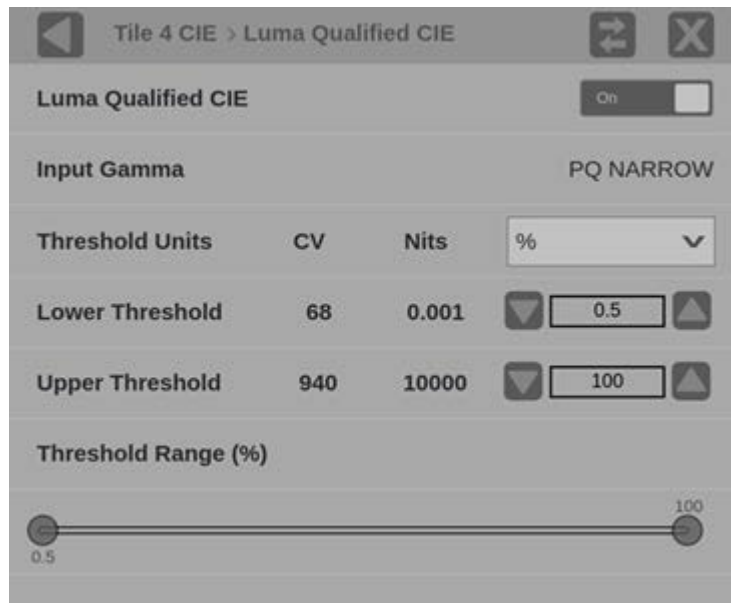

Luma Qualified CIE On constrains the CIE display within the specified user-defined limits. When Off is selected, the full luma range is shown within the CIE display.

Input Gamma shows the current gamma that is being used. This can be configured within the Virtual Input settings for the currently selected input.

The **Threshold Units** luma range can be selected in %, Nits or CV (Code Value) from the list.

You can adjust the **Lower Threshold** by using the up/down arrows or pressing on the value to bring up a keypad to enter the values directly. You can also use the left slider to adjust the value. The number is shown in the dialog box along with conversion for the other available values.

You can adjust the **Upper Threshold** by using the up/down arrows or pressing on the value to bring up a keypad to enter the values directly. You can also use the right slider to adjust the value. The number is shown in the dialog box along with conversion for the other available values.

The CIE Display in the upper left of the display shows whether the LQ CIE is Off or On and the selected luma range being used.

Here is the CIE display with the LQ CIE turned off. The full luma range of the signal is shown within the CIE display.

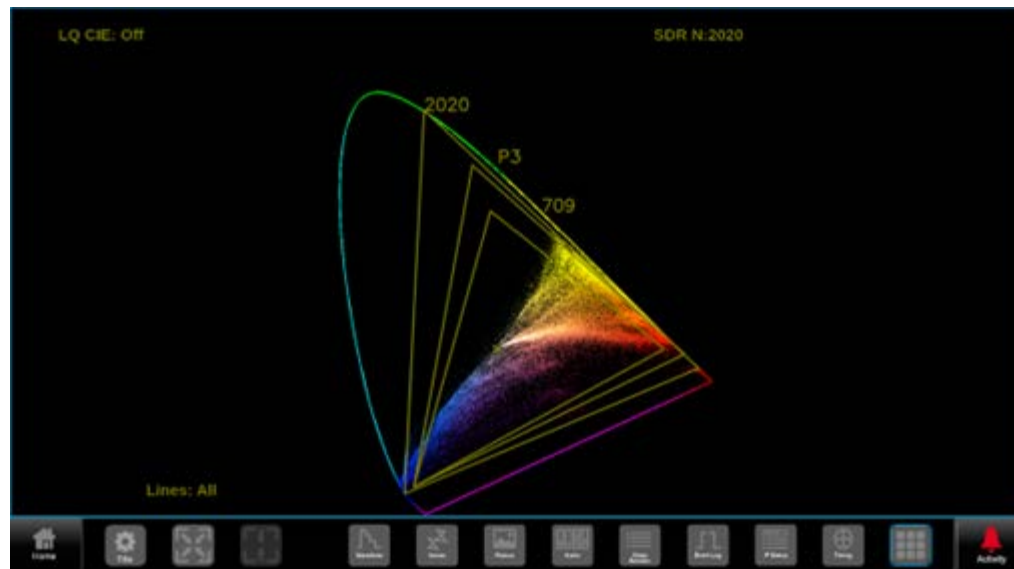

To aid in isolating a specific color range within the highlights or shadows, you can select a specific upper and lower luma threshold. In this case, the upper luma range has been set between a code value of 909 and a lower threshold of 608. When the LQ CIE is turned on, the trace is constrained within the specified luma range. In this case, the trace is constrained into the yellow color range, allow the operator to adjust the image more easily for this specific color range.

This LQ CIE display can be used in conjunction with the False Color Picture displays for Gamut or Luminance.

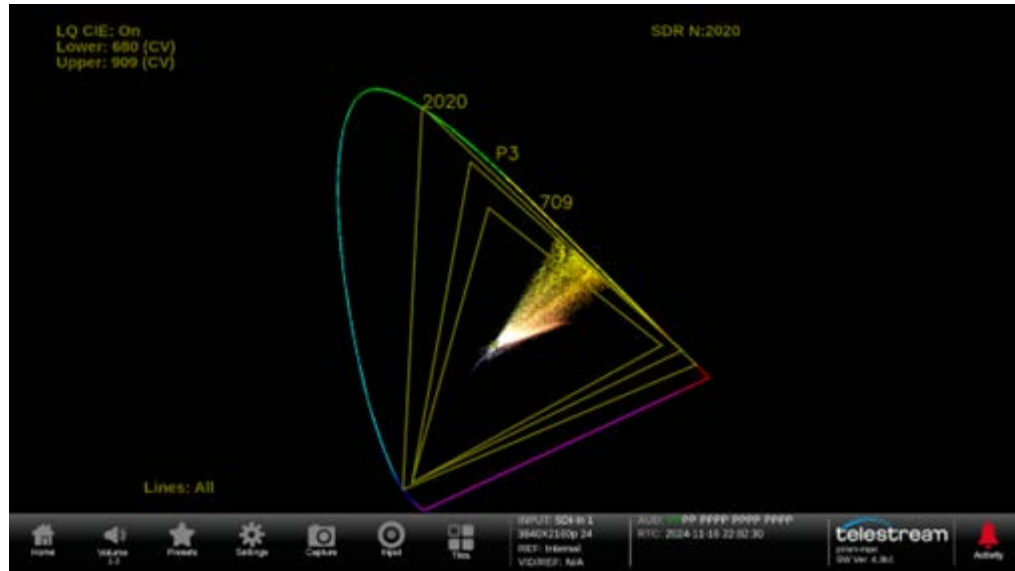



Stop Display Application

The Stop Display tool monitors video signals, with a variety of transfer functions, in a consistent manner. It helps the director of photography, cinematographer, and lighting engineer.

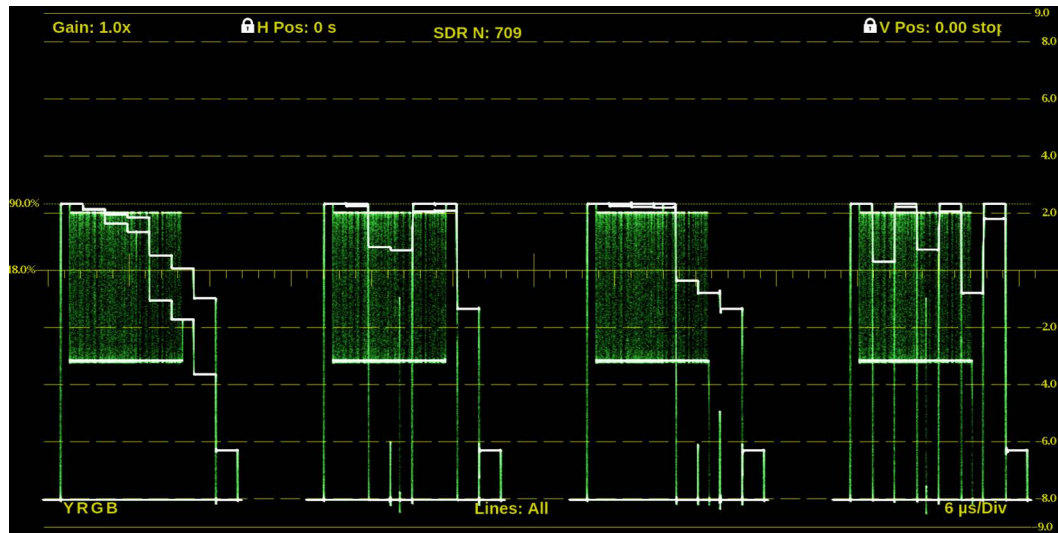
Note: Stop Display is enabled with Option MP2-PROD and is affected by the Gamma and Color Gamut settings. For additional information regarding these settings, see [Configure and Select Virtual Inputs](#).



Configure the Stop Display Application

1. Select the **Tiles** icon ().
2. Select the tile with the Stop Display application.
3. Select the **Tile** icon ().

Note: To move the settings left or right, select the **Move** icon () in the Settings menu header.

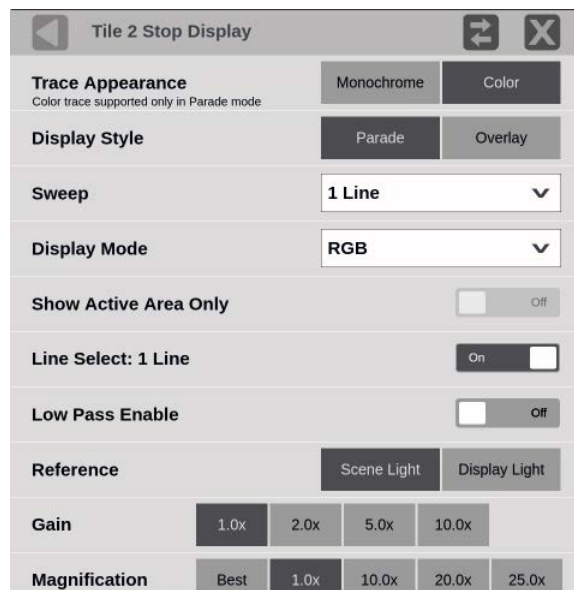

4. In the **Trace Appearance** section, select one of the following to change the colors of the parade traces:
 - **Monochrome:** Display all traces in a conventional green.
 - **Color:** Display the components of the traces in the colors described in the Display Mode. For example, the components in RGB mode are shown in red, green, and blue.

Note: The Color setting works only when Display Style is set to Parade. The Overlay mode displays the traces in green.

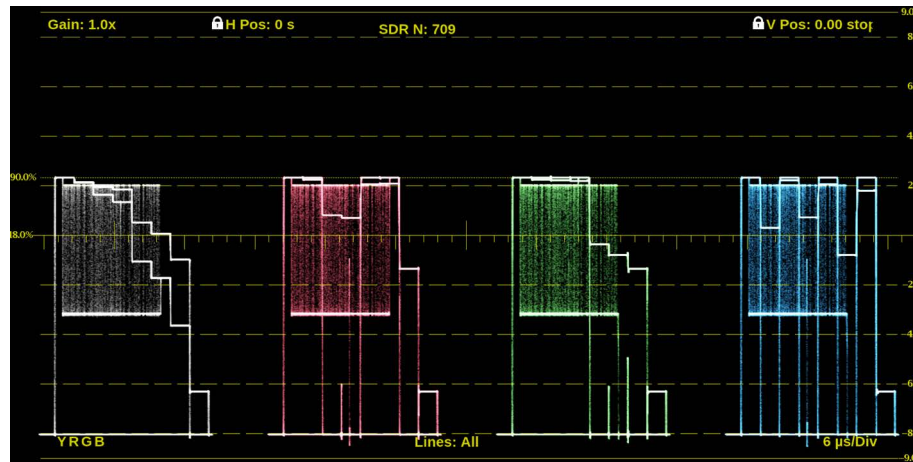

5. In the **Display Style** section, select the way signal components are displayed in the active tile:
 - **Parade**: All components are shown beside each other. This setting allows the traces to appear in the described colors.
 - **Overlay**: All components are drawn at the same location so they appear on top of each other. This trace is displayed in green.
6. From the **Sweep** list, select the waveforms to view between the lines or fields or make timing measurements on them. The options depend on the active display style.
 - When the Parade display style is active, you can select **1 line** or **1 field**.
 - When Overlay display style is active, you can select **1 line**, **2 line**, **1 field**, or **2 field**.
7. In the **Display Mode** list, select the display mode (available only while displaying SDI inputs):
 - **Y**: Displays the input as White (Y) for the Luma component. This display is the YRGB mode with the Red (R), Green (G), and Blue (B) components turned off.
 - **RGB**: Displays the input as R, G, and B components.
 - **YPbPr**: Displays the input as Y for the Luma component, and color difference Cyan (Pb) and Magenta (Pr) components.
 - **YRGB**: Displays the input as Y, R, G, and B components.

Note: The inputs are only shown in their colors if Trace Appearance is set to Color.

8. To remove the trace of vertical and horizontal blanking data, set **Show Active Area Only** to **On**.
9. Set **Line Select** to **On** to select 1 Line or **Off** to select All Lines. When Line Select is set to On (Line Select: Line 1), the display shows only results for the selected line in the picture. You can use on-screen tools to select the line; see [Line Select Function](#). Alternatively, you can select the line directly on the Picture.

- 10.** The Low Pass Enable setting is useful for isolating a specific characteristic of the input. Set **Low Pass Enable** as follows:
- **On:** Display only the low frequency of the signal.
 - **Off:** Display the full available bandwidth.
- 11.** In the **Reference** section, select one of the following:
- **Scene Light:** Shows a stop graticule in the vertical axis and is fixed regardless of the selected Gamma. It is used for scene setting and camera exposure adjustment.
 - **Display Light:** Shows a Nits graticule in the vertical axis and is fixed regardless of Gamma selected. It is used for mastering the content for a targeted HDR system.

This turns on the “Best” option in Gain.

The example is of the Display Light setting.

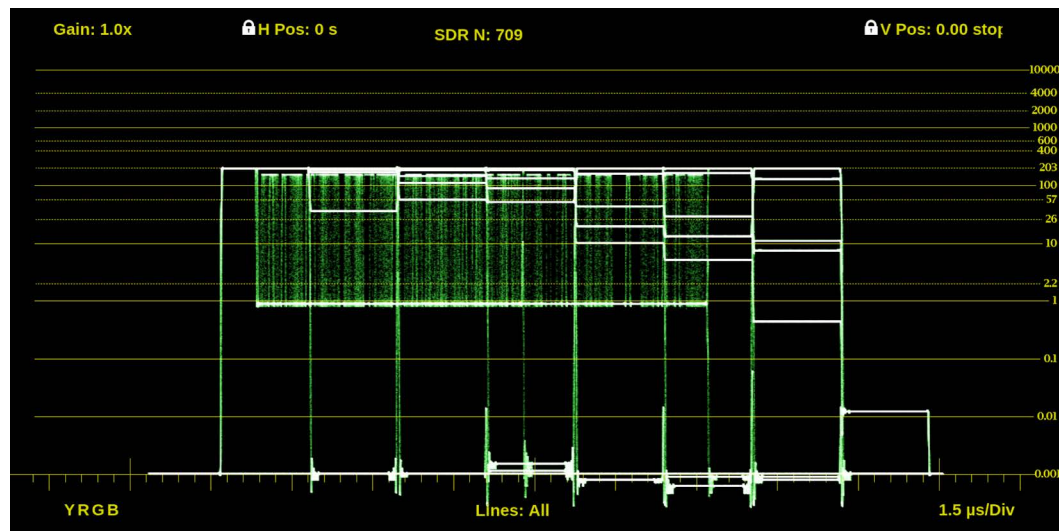

- 12.** In the **Gain** section, select the trace vector magnifications: **1.0x**, **2.0x**, **5.0x**, or **10.0x**. Best is available when you select Display Light in Reference. Display Light maximizes the trace height with 1,000 nits of brightness.
- 13.** In the **Magnification** section, select **Best**, **1.0x**, **10.0x**, **20.0x**, or **25.0x**.

Stop Display Application On-screen Tools

You can change the gain, display mode, and sweep—without opening the Stop Display menu—through on-screen tools. Select the tool/button for the setting you want to adjust. All the available tools are located on the top and bottom of the display and are highlighted for a few seconds when the application is first opened or if you select anywhere in the middle of the application tile.

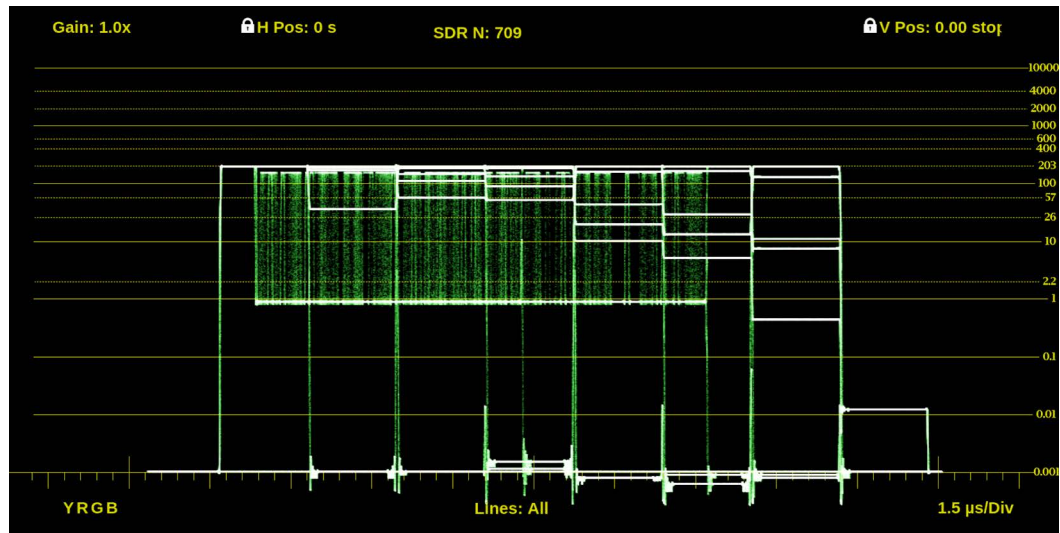

Gain

To increase or decrease the magnification of the trace display:

1. Select **Gain** to open the magnification menu.
2. Select one of the preset fixed-gain values: 1.0x, 2.0x, 5.0x, or 10.0x.
3. Select the **Reset** icon (🔄) to reset the gain to 1.0x.

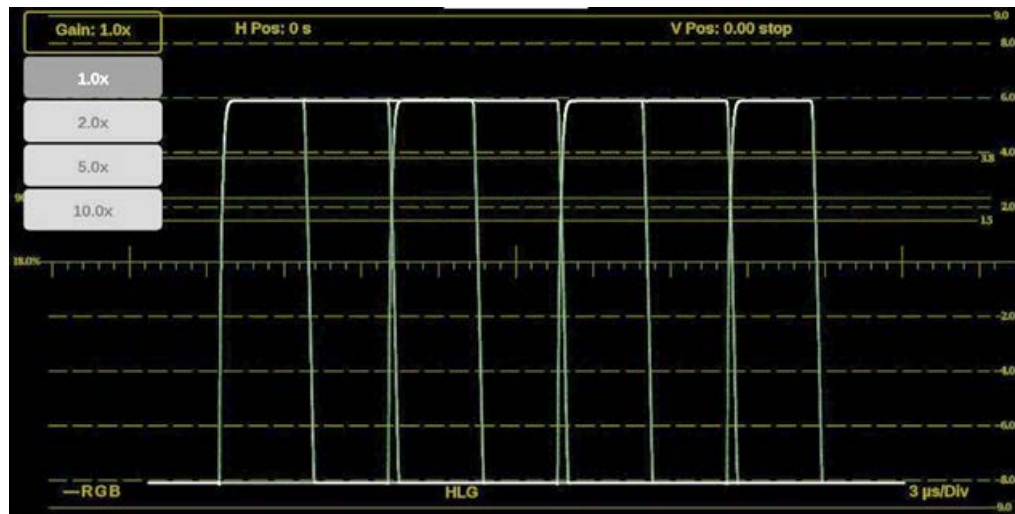

Horizontal and Vertical Position

To adjust the position of the trace display:

1. Select **H Pos** to allow adjustment of the horizontal trace.
 - Select-and-drag to move the trace on the touchscreen. This method can be performed without using the button.
 - Use a mouse scroll wheel to move the trace.

- For incremental adjustments, select the **Plus (+)** button or **Minus (-)** button to adjust the horizontal position.
- Select the **Reset** icon (🔄) to reset the horizontal position adjustment to default.

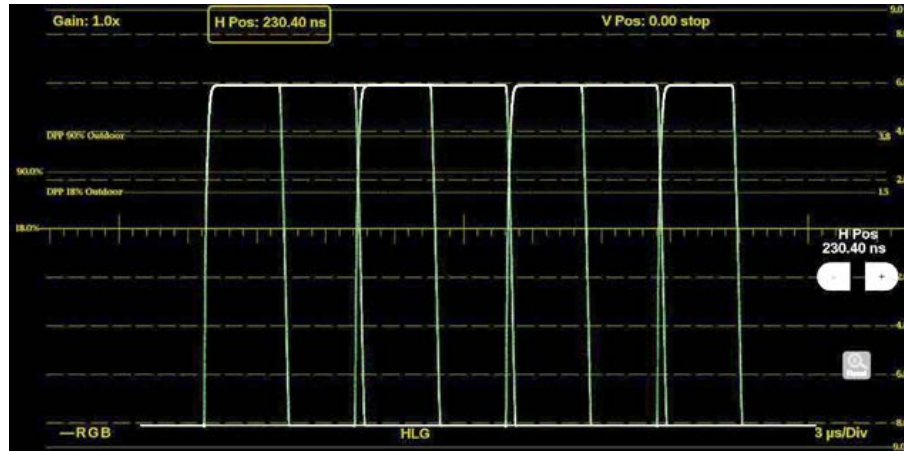

2. Select V Pos to allow adjustment of the vertical trace.

- Select-and-drag to move the trace on the touchscreen. This method can be performed without using the button.
- Use a mouse scroll wheel to move the trace.
- For incremental adjustments, select the **Plus (+)** button or **Minus (-)** button to adjust the vertical position.
- Select the **Reset** icon (🔄) to reset the vertical position adjustment to default.

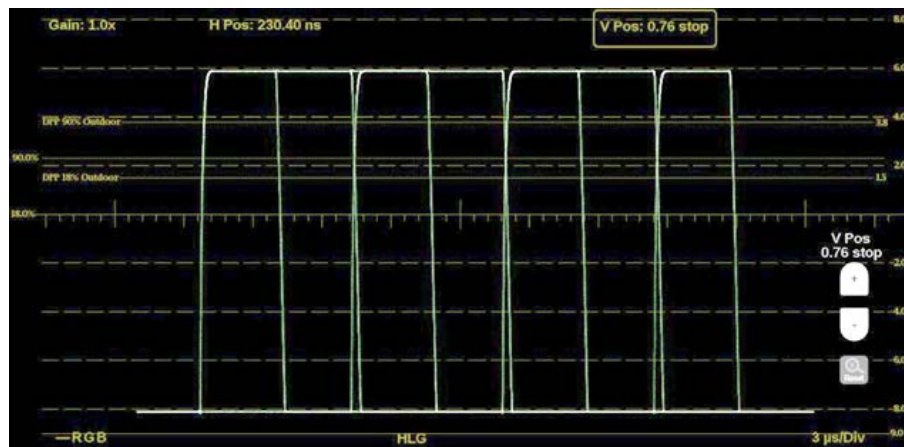

Display Mode

To change the displayed signal components:

1. Select the button in the bottom-left corner of the application to expand the available display options.
2. Select the components to view:

- In the list of components, select the letter of the color to remove it. For example, select R to remove the red trace.
- Select the letter of a removed component to make it visible.

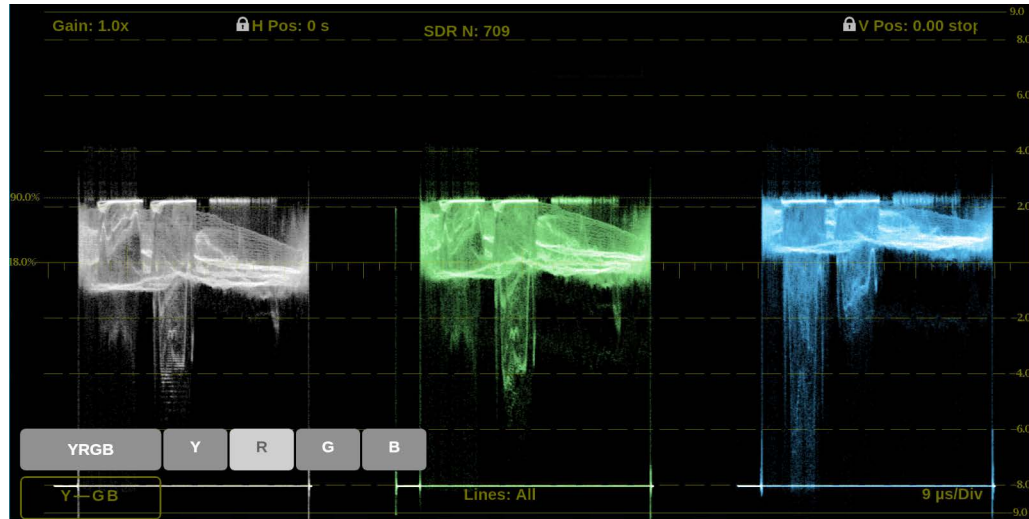

Display Format

To change the Display Style, Sweep, and Magnification of the Stop Display.

1. Select the button in the bottom right corner of the application to expand the available display format options.
2. Select the **Mag** option to set the magnification to Best, 1.0x, 10.0x, 20.0x, or 25.0x.
3. Select **Parade** or **Overlay** to switch between the Display Style options. The options depend on which Display Style is active.
 - When Parade display style is active, select from 1 line or 1 field.
 - When Overlay display style is active, select from 1 line, 2 line, 1 field, or 2 field.

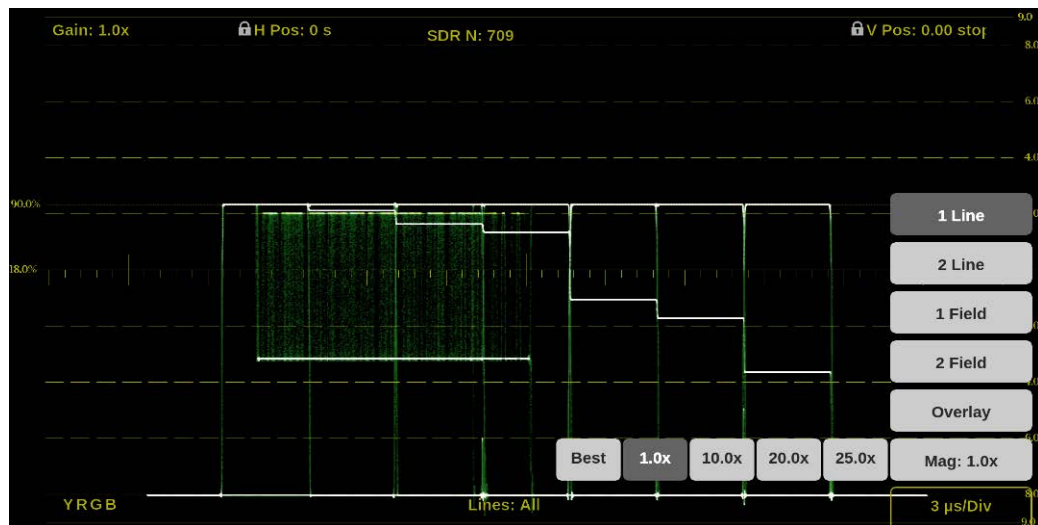

Line Select Function

You can select a single picture line to monitor in the display. By default, All Lines is selected and all lines are monitored.

Note: If you enable line select, the same line is selected in any trace display.

To turn on Line Select (and choose the line to monitor):

1. Select the **Lines** at the bottom of the tile.
2. Select **1 Line**.
 - To scroll through lines, select the **Plus (+)** button or **Minus (-)** button.
 - To enter a specific line to monitor:
 - ◆ select **Line Sel.** and enter the line on the keypad; or
 - ◆ in the Picture application, use the line-select cursor (for active lines).

Depending on the signal resolution, the Line Select provides different information.

- If a signal is SD, HD, or 3G:
 - ◆ the Line number is the selected line, including vertical blanking;
 - ◆ if the signal is interlaced format, the Fields readout is below the Line number;
 - ◆ the Pic Line number is next to Line; the Pic Line is the active line number, or numbers, selected.

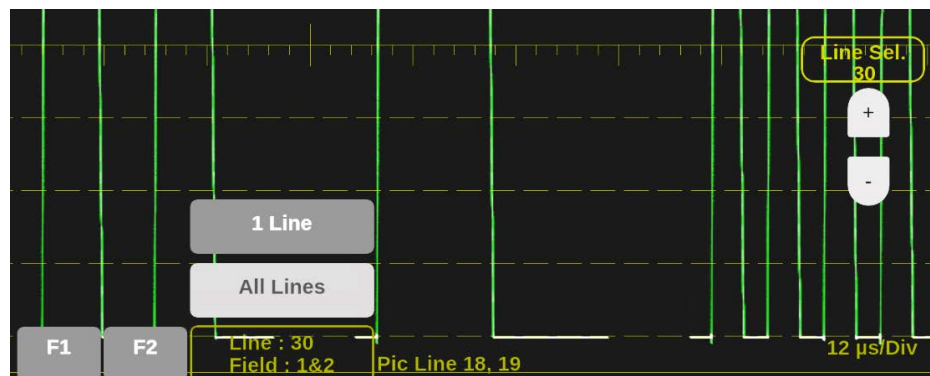

- If a signal is UHD or 4K:
 - ◆ the Line number is the selected raster line,
 - ◆ the SDI Line is the selected line including vertical blanking,
 - ◆ the link number appears below the SDI Line.

In link, the letters (A-D) refer to the physical links. The numbers (1-4) refer to the virtual links. For example, A3/62 indicates it is physical link 1 and virtual link 3 (in a two-sample interleave, 12G transport).

CAM Application

The CAM application displays the output of up to four cameras to check color levels and balance when MULTI input is selected.

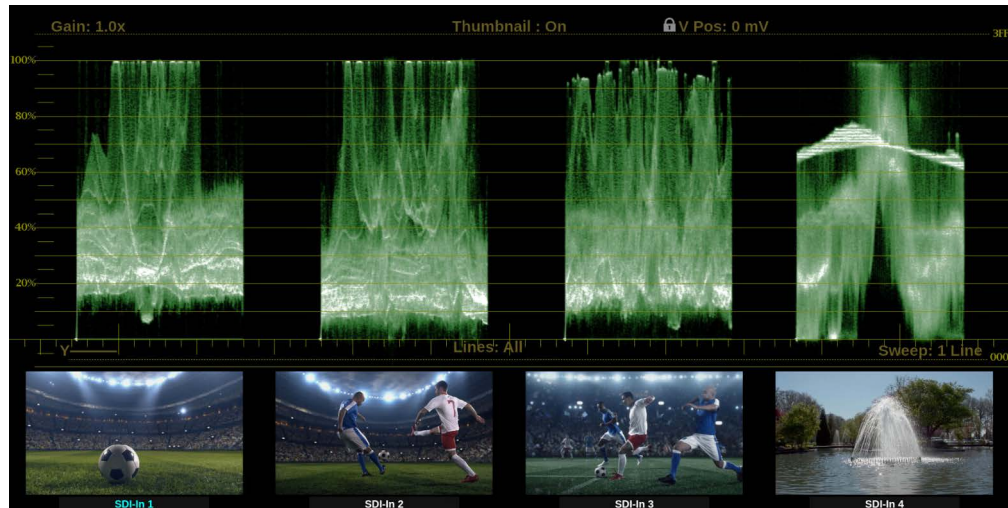

Source Label Overlay

The source label overlay is format information that includes the picture format, frame rate, structure, and gamma curve for that channel. It appears at the bottom of the CAM application tile, over the camera thumbnails if they are displayed.

The format information overlay can be set to turn off after 5 seconds, dim after 5 seconds, or never turn off. The format information does not appear if the instrument is not in multi-input mode.

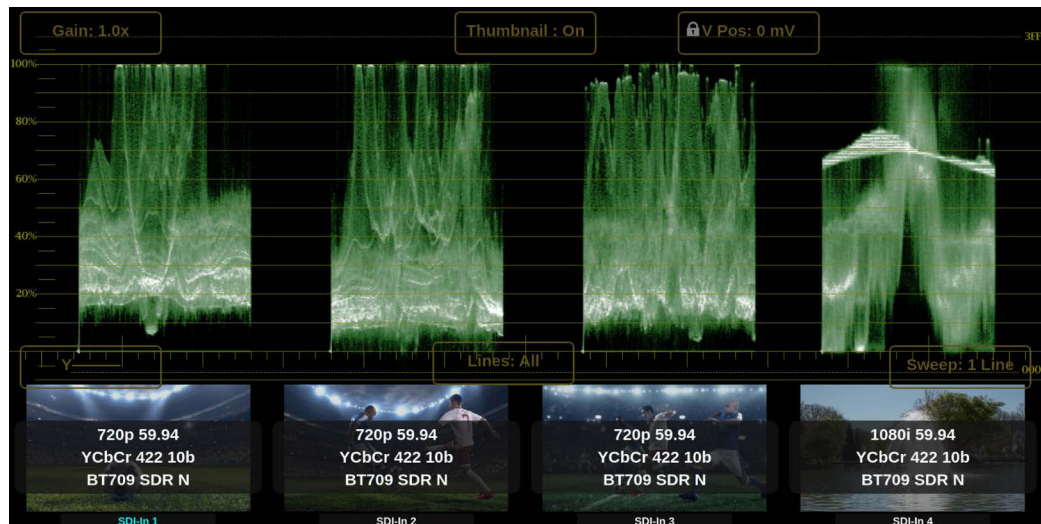

To change the format information overlay:

1. Select the **Settings** icon (⚙️) and then select **Display**.
2. Select **MULTI INPUT** and select the **Source Label Timeout** option.



Configure the CAM Application

1. Select the **Tiles** icon (🧩).
2. Select the tile with the CAM application.
3. Select the **Tile** icon (⚙️).

Note: To move the settings left or right, select the **Move** icon (↔️) in the Settings menu header.

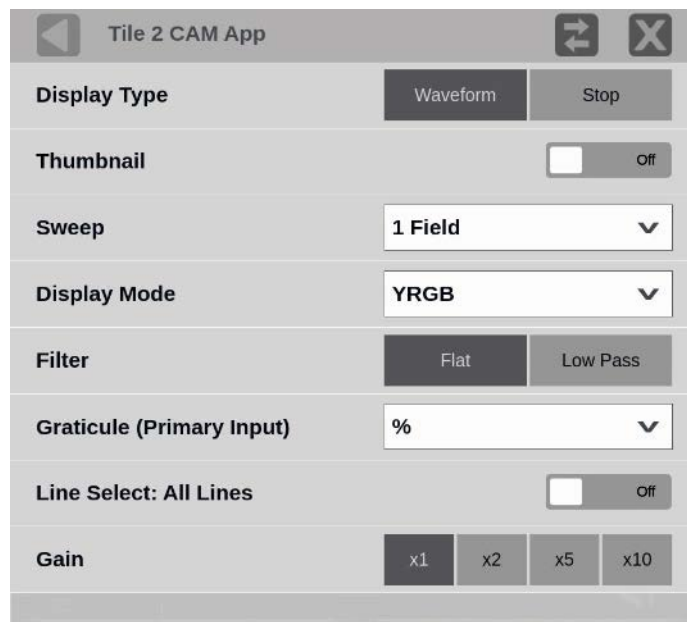

4. Set to **Waveform** or **Stop**. The Waveform setting makes the CAM application act like the Waveform application. See [Waveform Application](#). The Stop setting makes the CAM application act like the Stop Display application. See [Stop Display Application](#). To use the Stop setting in the Display Type, the MP2-PROD license is required.
5. Set **Thumbnail** to **On** to show a small picture of each input at the bottom of each input channel.

6. From the **Sweep** list, select the sweep rate: **1 Line** or **1 Field**.
7. From the **Display Mode** list, select one of the following:
 - **Y**: Displays the input as White (Y) for the Luma component. This display is the YRGB mode with the Red (R), Green (G), and Blue (B) components turned off.
 - **RGB**: Displays the input as R, G, and B components.
 - **YRGB**: Displays the input as Y, R, G, and B components.
8. Waveform filters are useful for isolating a specific characteristic of the input. For example, you can enable a Low Pass filter for quick camera exposure setting. In the **Filter** section, select a waveform filter:
 - **Flat**: Display the full available bandwidth.
 - **Low Pass**: Display only the low frequency part of the signal.
9. From the **Graticule** list, select a vertical scale value. The options depend on whether the Display Type is set to Waveform or Stop.

In multi-input, the primary input is used for graticule selection. When inputs have different gammas, select the input of interest as the primary input to get the correct graticule.

The Code Value vertical unit is a hexadecimal value. The Stop, Reflectance, and Nits scale are drawn differently, depending on the gamma setting in the input menu.

 - **Waveform Options**:
 - The % value is a fixed graticule. It is compatible with the traditional waveform scales.
 - The Stop graticule is the Scene light graticules for scene setting and camera exposure adjustment.
 - The Nits graticule is the Display light graticule for mastering the content for a targeted HDR system.
 - **Stop Options**:
 - The Log Nits graticule is the Display light graticule for mastering the content for a targeted HDR system using Stop application processing.
 - The Log Stops graticule is the Scene light graticules are for scene setting and camera exposure adjustment using Stop application processing.
10. Set **Line Select** to **On** to monitor one raster line in the display or **Off** to monitor all lines. When Line Select is set to On (Line Select: Line 1), the display shows only results for the selected line in the picture. You can use on-screen tools to select the line; see [Line Select Function](#). Alternatively, you can select the line directly on the Picture.
11. In the **Gain** section, select the vertical gain of the trace display: to **x1**, **x2**, **x5**, or **x10** times.

Choose Inputs for CAM Application

The channel images shown in the CAM application are determined by the Select channels in the Multi Input menu. The channels are chosen from those listed in the Input menu. Up to four channels can be shown in the CAM application at one time.

The instrument can show up to four trace applications (Waveform, Vector, Lightning, Diamond, CIE, or Stop Display) at the same time. Each input channel in the CAM application acts as one of those trace applications. That is, if three tiles are showing trace applications, the CAM application can show only one input. If the CAM application shows four inputs (inputs coming into the instrument), no other tiles can show trace applications.

To automatically give the CAM application access to the four trace applications, change the CAM application tile to full screen. Up to four channels are immediately available in the CAM application.

To select channels to see in the CAM application:

1. Select the **Input** icon () in the status bar.
2. Select the **Multi Input** menu button from the Input bar.

Note: If “Multi:” is not in the Input menu and the Multi menu button is not active, the MP2-MULTI option might not be installed.



3. Set Multi Input to **ON**.
4. Set Edit Mode to **ON**.

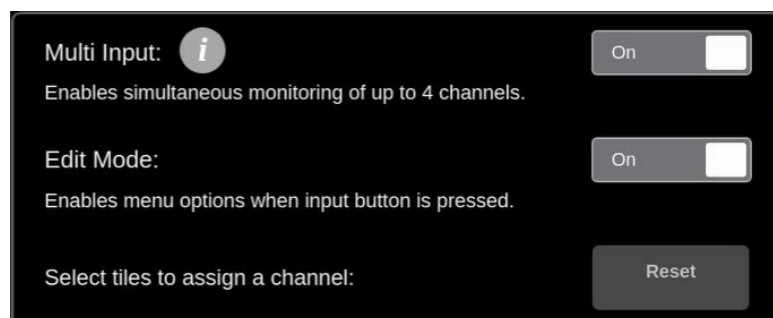

5. To set the inputs in Select channels:
 - Add a channel to the **Select channel** list; select the channel in the **Input** menu and select **Add Channel**. The CAM application shows the channel in the tile immediately.

Note: Select **Make Primary** to enable the graticules for the needed gamma.

The example shows three channels in the Select channel list from the Input menu, so the CAM application shows those three channels in the order they are in the Input menu, not the order they are chosen for the Select channel list.



- Remove a channel from the Select channel list; select the channel in the Input menu and select **Remove Ch**. The CAM application removes the channel from the tile immediately.

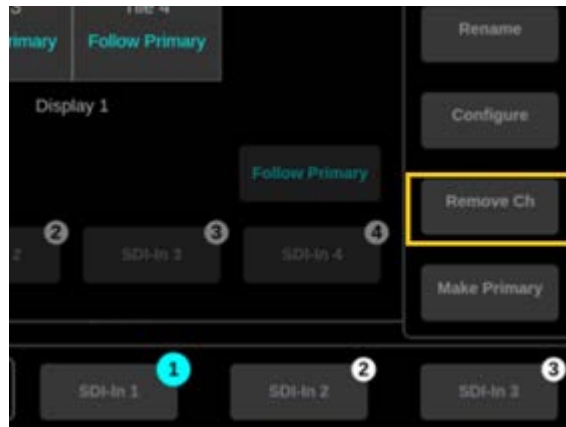

6. Select the channel in the Input menu again to close it.
7. Select the **Multi Input** menu button again to close the menu.

CAM Application On-screen Tools

You can change the gain, horizontal position, vertical position, thumbnail (on or off), display mode, line select, and sweep rate—without opening the CAM Settings menu—through on-screen tools. Select the button for the setting you want to adjust. All the available tools are located on the top and bottom of the display and are highlighted for a few seconds when the application is first opened or if you select in the tile heading.

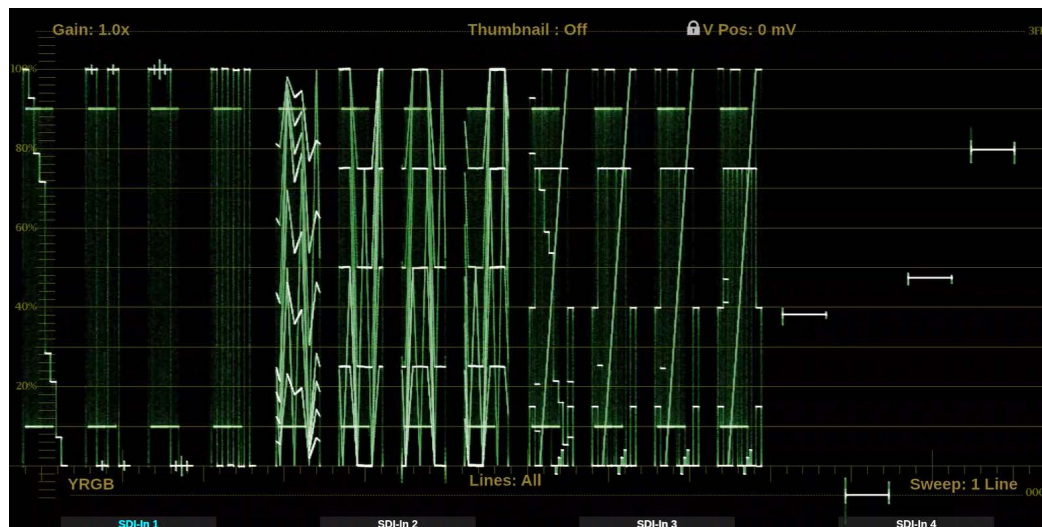

Gain

To increase or decrease the vertical gain of the trace display:

1. Select **Gain**.
2. Select a preset gain: **1.0x**, **2.0x**, **5.0x**, or **10.0x**.

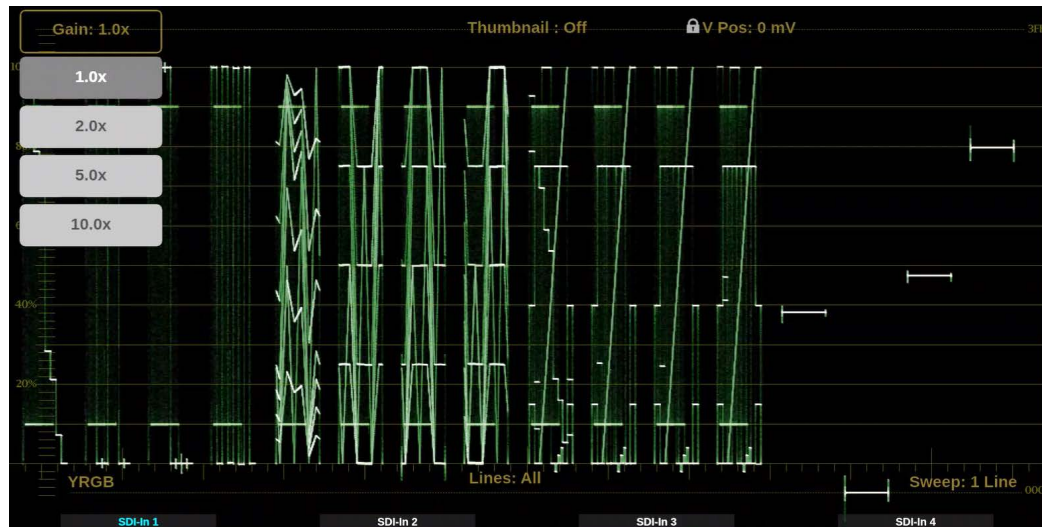

Thumbnail

Select **Thumbnail** and then select **Thumbnail : Off** to turn on the thumbnail under the CAM signal image.

Select **Thumbnail : On** to turn the thumbnail off.

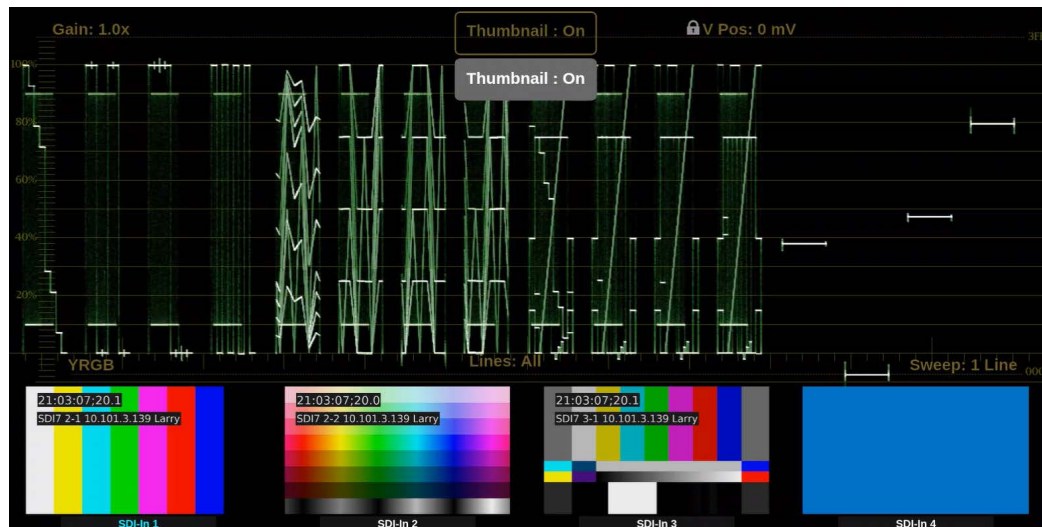

Vertical Position

Select **V Pos** to adjust the vertical trace. Select the button to turn the lock off and on.

- Select-and-drag to move the trace on the touchscreen. This method can be used if the setting is locked or not. The V Pos button must be unlocked (no lock-symbol) for the select-and-drag to work.
- For incremental adjustments, select the **Plus (+)** button or **Minus (-)** button to adjust the vertical position.

- Select the **Reset** button () to move the signal image back to 0.

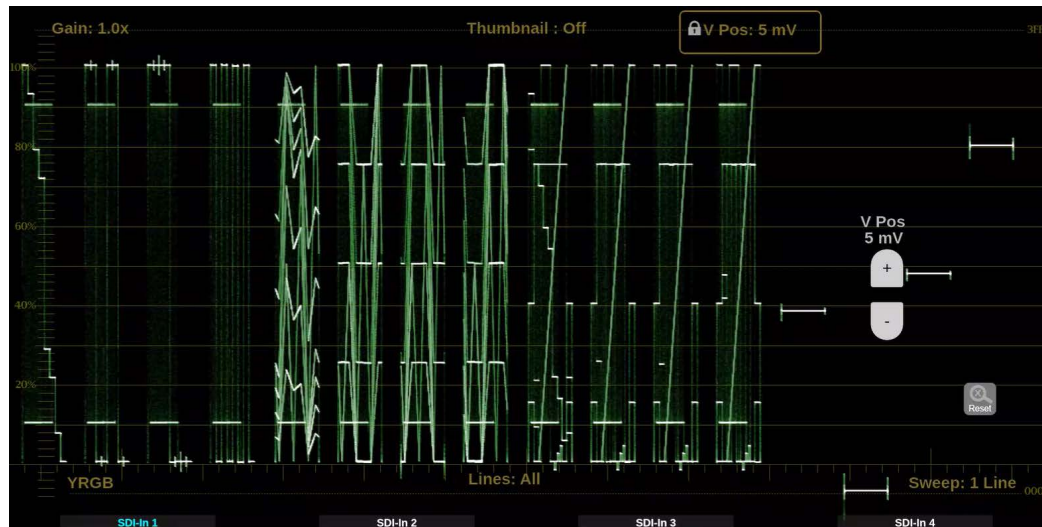

Display Mode

Change how the waveforms are displayed.

1. Select the button in the bottom left corner of the application to expand the available display options (the button label varies depending on the last option selected).
2. Select the components to monitor:
 - In the waveform list of components, select the letter of the component to remove it. For example, select G to remove the green component from the waveform.
 - Select the letter of a removed component to make it visible.

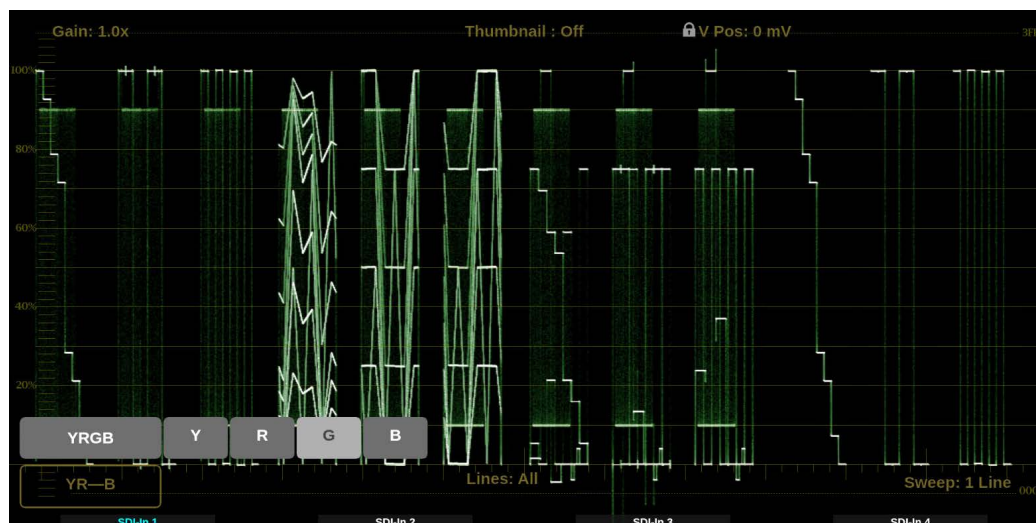

Line Select Function

Line Select allows you to select a single raster line to monitor in the display. By default All Lines is selected and all lines are monitored. The same line is selected in any trace display if Line Select is enabled.

To turn on Line Select (and choose the line to monitor):

1. Select **Lines** at the bottom of the tile.
2. Select **1 Line**.
 - To scroll through lines, select the **Plus (+)** button or **Minus (-)** button.
 - To enter a specific line to monitor: select **Line Sel.** and enter the line on the keypad.

To turn Line Select off and monitor all lines, select the **Lines** button at the bottom of the tile and select **All Lines**.



Sweep

To change the sweep to 1 line or 1 field, select the button in the bottom right corner of the application and select **1 Line** or **1 Field**.

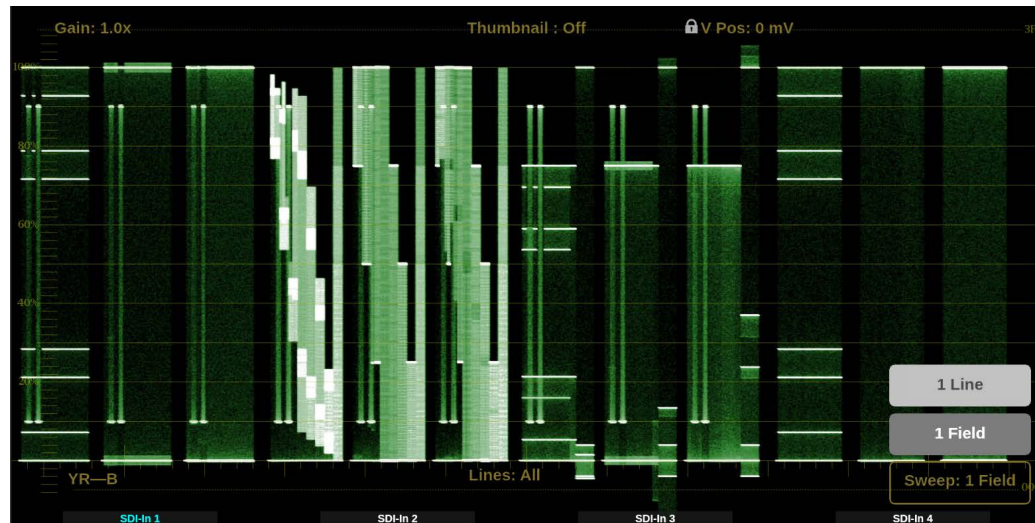

Picture Application

The Picture display lets you see the picture generated by the video signal.





(Copyright 2008, Blender Foundation / www.bigbuckbunny.org)

Note: Tiles displaying the Picture application in multi-input mode and viewing secondary inputs do not show content from all 4K contribution links.

In full-screen mode, there is no cropping. Pictures are decimated horizontally or vertically to obtain the correct aspect ratio. This decimation may cause some artifacts.

Configure the Picture Application

1. Select the **Tiles** icon ().
2. Select the tile with the Picture application.
3. Select the **Tile** icon ().

Note: To move the settings left or right, select the **Move** icon () in the Settings menu header.

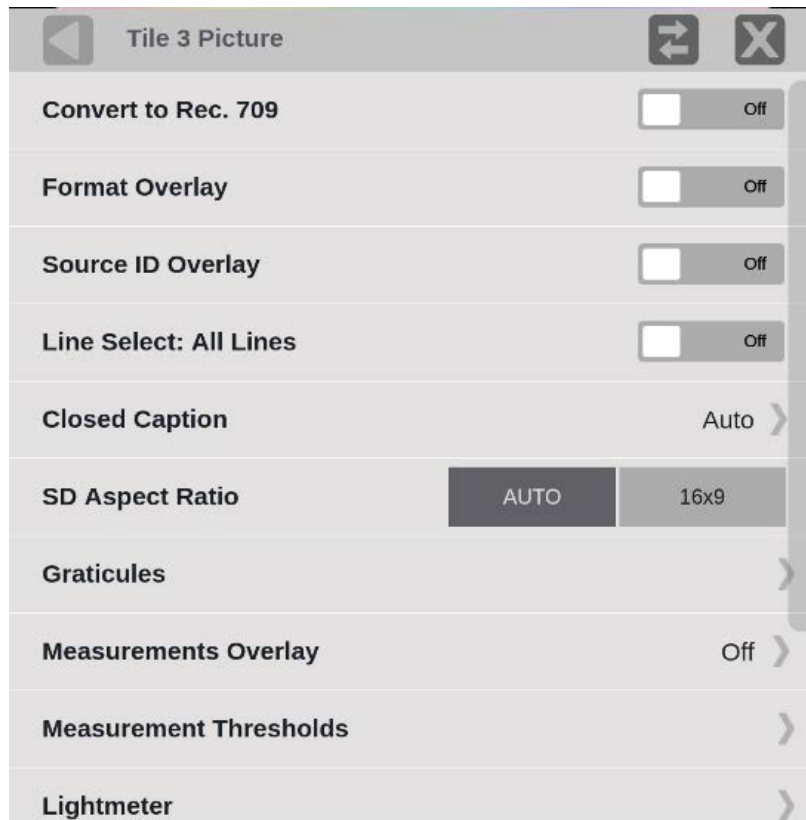

4. Set **Convert to Rec. 709** to **On** to allow the trace displays to convert camera logs to Rec. 709 (requires Option MPSPD-PROD).

Note: In multi-input mode, Convert to Rec. 709 works only with the primary channel. Convert to Rec. 709 mode is not supported for SD signals.

5. Set **Format Overlay** to **On** to display the format information on top of the picture. Select and drag the format information window to set the location.
6. Source ID Overlay provides an overlay of the video source on the Picture application. The source data carries ANC data conforming to ST 291M. The default DID is 0x53 and, SDID is 0x49. Set them as required. The source ID is limited to 15

ASCII characters. To enable the Source ID Overlay, set the Source ID Overlay to On. Select and drag the overlay to the correct location on the application.

Note: In multi-input mode, Source ID Overlay works only with the primary channel.

7. You can select the picture line to monitor in the available trace displays, including Waveform, Stop, Vector, Diamond, Lightning, and CIE. Set **Line Select** to **Off** to select All Lines or **On** to select 1 Line. If you select 1 Line, a horizontal line appears on the picture. To choose a line to monitor, select and drag the line. The selected line number is noted on the line.
8. For information about configuring closed caption/subtitle formats and service, see [Closed Caption/Subtitles: Details](#).
9. In the **SD Aspect Ratio** section, select one of the following SD (standard definition) aspect ratios:
 - **AUTO:** The AFD data will set the aspect ratio
 - **16x9**Selecting an option that has non-SD input has no effect.
10. For information about configuring safe area graticules, including AFD and AFD data, see [Graticules: Details](#).
11. You can adjust the visibility of the available picture measurements. For details, see [Measurement Overlay: Details](#).
12. For information about configuring the threshold for HDR picture measurements, see [Measurement Thresholds: Details](#).
13. The Lightmeter displays the light level (in nits or stops) at the point marked by the Lightmeter cursor in the Picture display. For more information about this feature, see [Lightmeters: Details](#).
14. The Input Gamma section indicates the input Gamma set in the Settings menu for the selected input.
15. Select **False Color** option to turn on false color. The false-color displays apply a color palette to the picture to highlight attributes associated with images. See [False Color: Details](#) for more information about this feature.)

Closed Caption/Subtitles: Details

Note: In multi-input mode, Closed Caption/Subtitles works only with the primary channel.

The Closed Caption/Subtitles conform to ST 334:2015.

To configure closed captions/subtitles:

1. In the **Picture Settings** menu, select **Closed Caption**.

2. To turn on the CC Information Overlay, set **CC Information Overlay** to **On**. The CC Information Overlay provides closed caption/subtitle format and service information. To move the overlay, select the overlay and drag it to the new location within the tile.
3. In the **Captions/Subtitles Transport** section, select a format to decode and open the service options:
 - **OFF**: Turns off the closed caption decoding. The overlay remains in the Picture tile if it is on.
 - **Auto**: Detects and selects the closed captions/subtitles format in the signal and presents the service options. Select the appropriate input.
 - **CEA608**: A standard format of closed captions/subtitles data used in the U.S., Canada, and Mexico for analog TV transmissions. If a service has no activity for 10 seconds, it is considered missing.
 - ◆ In the **CEA608 Channel** section, select the appropriate input (1 through 4).
 - **CEA708**: A standard format of closed captions/subtitles data in the U.S. and Canada for digital TV transmissions. If a service has no activity for 10 seconds, it is considered missing.
 - ◆ In the **CEA708 Service** section, select the appropriate input (1 through 6).
 - **WST**: Also called Teletext, WST is a standard format for closed captions/subtitles in many parts of the world. Support includes OP-47 and 2031.
 - ◆ In the **Teletext Page** box, set the page number for your region. Select the up or down arrow, or select the number and use the pop-up keypad.
 - ◆ PRISM supports the complete primary character set for general Latin-based languages, plus secondary character sets for additional symbols, accents, and characters specific to:
 - English
 - Portuguese
 - Spanish
 - French
 - German
 - Italian
 - **ARIB**: This is a standard B24 of decoding.
 - ◆ In the **ARIB Type** section, select the appropriate format: **HD**, **SD**, or **Mobile**.
 - ◆ **TTML2**: An XML-based format for the interchange of captions and subtitles over ST 2110-43 transports. If TTML transport is selected or if detected using the AUTO setting, then additional information is presented.



- ◆ In the **Selected TTML2 Language Track** box, you can select a language track between 1 and 10 even if the language track is not currently available. The selected language track is saved in presets, which is one reason why you might want to select a language track that isn't currently available.
- ◆ The **Detected Languages** section displays the track number and detected language for available TTML tracks. The supported character sets are Latin, Cyrillic (1/2/3), Hebrew, Arabic, and Greek. The supported national option sets are English, German, Italian, French, Portuguese, and Spanish.

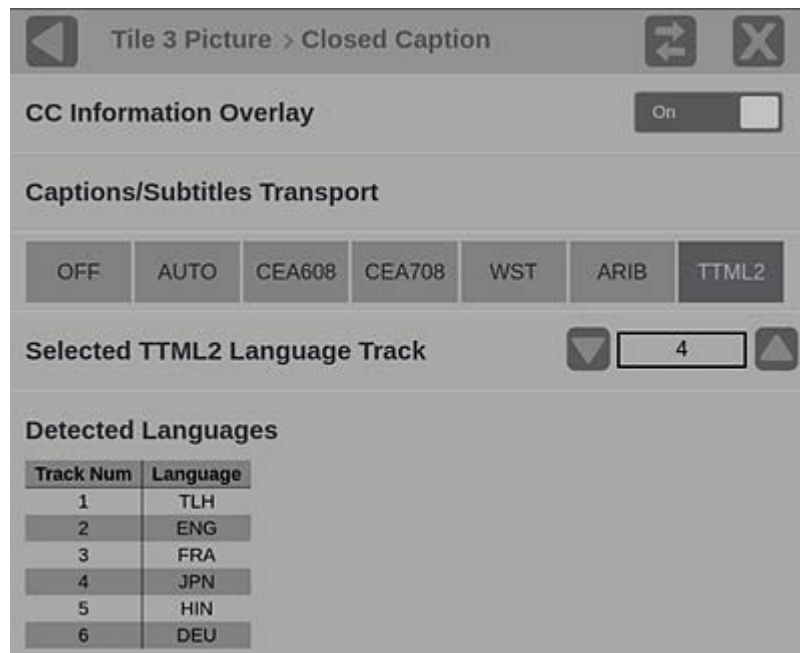

Note: Each Picture tile can select a closed caption format and a service.

Gaticules: Details

Note: Gaticules conform to industry standard ST 2016-1.

This section explains how to turn safe area graticules on and off, including AFD.

To configure graticules:

1. In the **Picture Settings** menu, select **Graticules**.

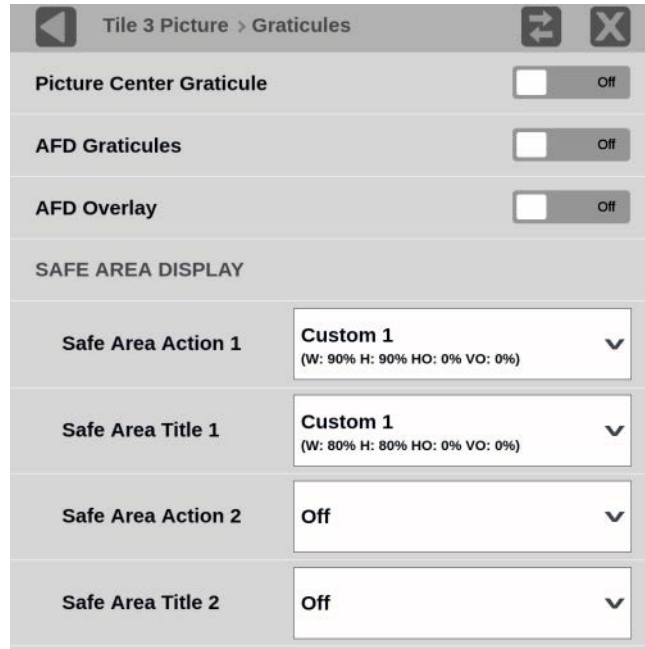

The AFD graticule frame is based on input AFD data. These are not adjustable.

2. In the **Graticules** menu, select from the options as needed:
 - To show the center crosshairs, set **Picture Center Graticule** to **On**. The crosshairs appear in the middle of the selected Picture tile whether there is AFD data or not.
 - To show the AFD frame, set **AFD Graticules** to **On**. The dashed line is the received AFD data aspect ratio. If AFD data is not present, the graticule will not be displayed.
 - To show the AFD on-screen information, set **AFD Overlay** to **On**. The AFD data description appears in the selected Picture tile even if there is no AFD data.

Note: The Bar1 and Bar2 data complies with ST 2016-1-2009.

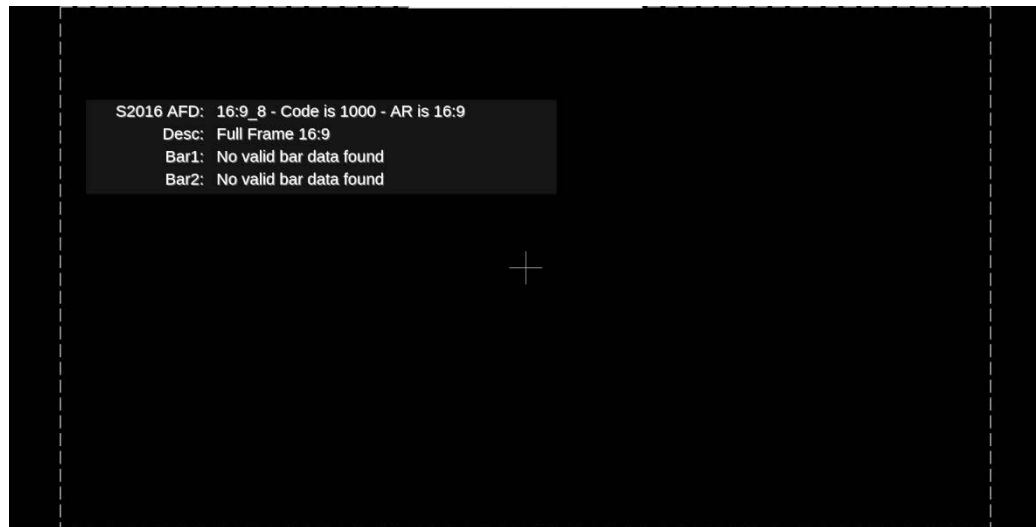

3. For information about changing the colors of the AFD graticule and the Picture Center Graticule, see [Configure Graticule Colors](#).
4. The safe areas for each Picture tile are independent of other Picture tiles. You can change a Picture tile to display any, all, or none of the Safe Area Action or Title options while nothing changes in any other Picture tiles.
Select a ratio for the Safe Area Standards (SMPTE, ITU, and ARIB TR-B.4) to turn on the graticules in a Picture tile. To change the Safe Area Standard that is used, see [Configure Safe Area Graticules](#).

AFD Overlay		Off
SAFE AREA DISPLAY		
Safe Area Action 1	Off	▼
Safe Area Title 1	Off	▼
Safe Area Action 2	Off	▼
Safe Area Title 2	Off	▼
Set custom configurations in Settings > Display > Safe Area Graticules		

SAFE AREA DISPLAY	
Safe Area Action 1	Off
Safe Area Title 1	Auto
Safe Area Action 2	4x3
Safe Area Title 2	14x9
	16x9

- The Safe Area Action 1-2 menus turn on a solid line defining a safe area.
- The Safe Area Title 1-2 menus turn on a dashed line defining a safe area.

Note: The safe areas for each Picture tile are independent of other Picture tiles. You can change a Picture tile to display any, all, or none of the Safe Area Action or Title options while nothing changes in any other Picture tiles.

5. Select a safe area ratio option: **4x3**, **14x9**, or **16x9**. The standard safe area in a Picture tile depends on the selected ratio.

Note: These ratios do not affect the AFD graticules.

SAFE AREA DISPLAY	
Safe Area Action 1	16x9
Safe Area Title 1	16x9
Safe Area Action 2	Off
Safe Area Title 2	Off

6. You can define custom safe areas. Select the **Custom 1** and **Custom 2** options to see the custom-defined space in a Picture tile. These safe areas are set independently and, if selected, override the standard safe area selection. The specifics of each custom graticule are listed under the Custom 1, Custom 2 names. For details about setting the Custom Safe Areas, see [Set Custom Safe Areas](#).

There are two custom options in each menu.

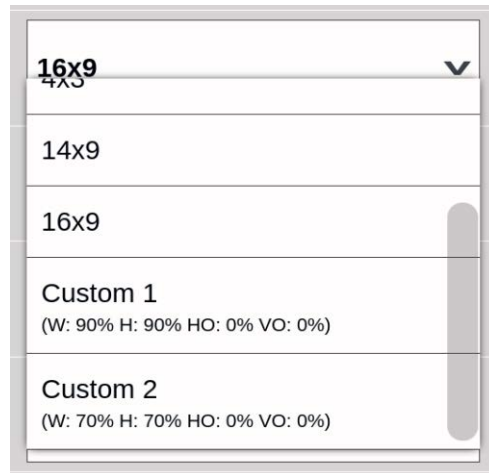

Picture Measurements

Note: In multi-input mode, Picture Measurements works only with the primary channel.

To turn on the overlay containing a selectable set of picture measurements (including HDR measurements):

1. Select the **Picture** application.
2. In the **Applications** menu, select the **Tile** icon (⚙️).
3. If needed, select the measurement overlay and drag it to set the location.



Measurement Overlay: Details

1. In the **Picture Settings** menu, select **Measurements Overlay**.
2. Set **Measurements Overlay** to **On**. The Measurements Overlay appears in the Picture application. After it is visible, you can select the overlay window and drag it to any location in the Picture tile.

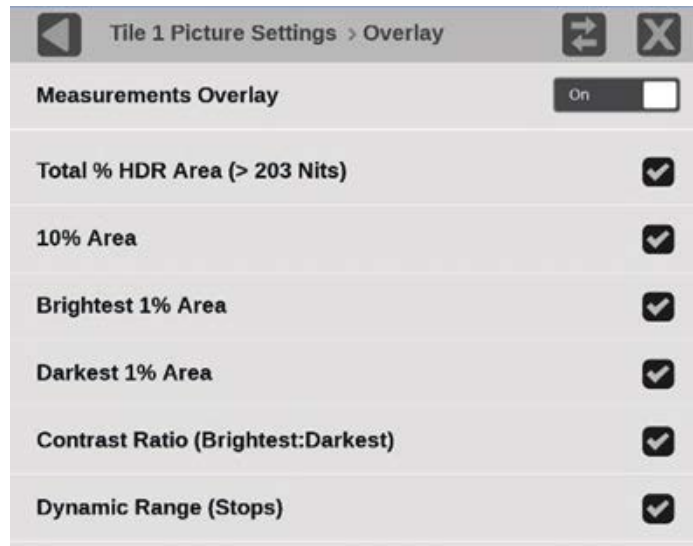

3. Select the checkboxes of the picture measurements to make them visible in the overlay. Clear the checkboxes to remove the measurements from the overlay. A threshold setting is required for many of the parameters. See the Measurement Threshold menu for setting these thresholds.

These measurements are available—settable thresholds are indicated by x:

- Total percent HDR area the nits threshold for this measurement can be set.
- X percent area, in nits
- Brightest x percent Area, in nits
- Darkest x percent Area, in nits
- Contrast Ratio (Brightest:Darkest)
- Dynamic Range (stops = $\text{Log}_2(\text{Brightest } x \text{ percent} / \text{Darkest } x \text{ percent})$).

Measurement Thresholds: Details

To set the thresholds for picture measurements that require them:

1. Select **Measurement Thresholds** in the **Picture Settings** menu.

Note: These settings also affect the HDR alarm settings, see [HDR](#) in the alarms table.

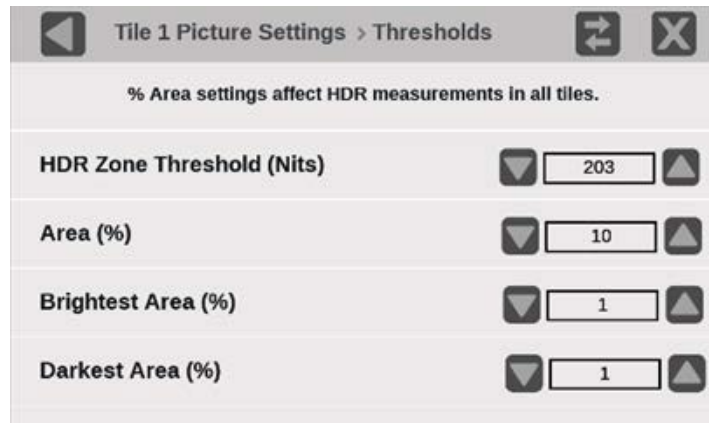

2. Specify the following thresholds as needed:

- **HDR Zone Threshold (Nits):** Any picture value higher than this threshold, in nits, is considered to be in the HDR zone.
- **Area (%):** Defines the brightest percentage of the picture used to determine the bright threshold in nits.
- **Brightest Area (%):** Defines the brightest percentage of the picture used to determine the HDR threshold in nits.
- **Darkest Area (%):** Defines the darkest percentage of the picture used to determine the dark threshold in nits.

Lightmeters: Details

Note: In multi-input mode, Lightmeters work only with the primary channel.

The Lightmeters measure the light level, in nits or stops, at the point marked by the Lightmeter cursor in the Picture application. Proper operation requires selecting the appropriate Gamma Curve in the input settings. (See [Gamma Curve](#).)

Select the **Picture** application and then, in the applications menu, select the **Tile** icon (.

Note: The readout is the average luminance of a 5x5 pixel area in a 1920x1080 picture, a 10x10 pixel area in a 3840x2160 picture, and a 20x20 pixel area in a 7680x4320 picture.

Turn on Lightmeters Cursors

1. Select the **Picture** application and then, in the applications menu, select the **Tile** icon (.
2. Select **Lightmeter**.
3. Set the **Lightmeter Overlay** to **On**.

4. Select the number of needed Lightmeter cursors (up to 5).

Note: The Lightmeters all use the same method for measurements. The color of the Lightmeter cursor is just for identification.



The Lightmeters are visible in the Picture application.

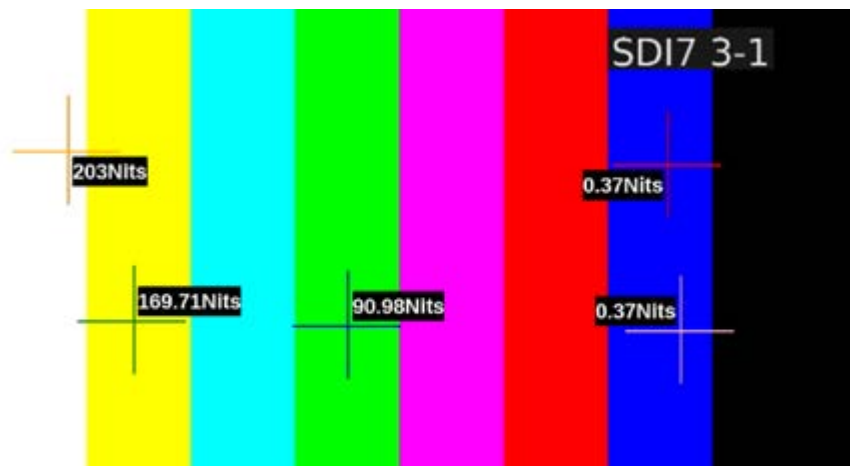

Adjust Lightmeters Cursors

- To move the Lightmeter cursors, select any part of the crosshairs or the measurement numbers and drag the target to the new location. The measurement updates automatically.
- To remove a selected Lightmeter cursor from the Picture, clear the checkbox of the color in the Picture Settings menu.
- To remove all the Lightmeters cursors from the Picture, clear the checkboxes of all the Lightmeter colors or set the Lightmeter Overlay to Off.

False Color: Details

1. Select the **Picture** application and then, in the applications menu, select the **Tile** icon ().
2. From the **False Color** list, select a false color palette. The false color turns on and shows the selected option:
 - **Gamut:** Use for a quick check of gamut compliance to Rec. 709 and P3 gamut limits. Select **Outside 709** or **Outside P3** to change the color palette in the Picture tile.
 - **% Area:** A fixed false-color palette is applied to regions of the picture with Brightest, Area, and Darkest. Any or all of these false colors can be disabled by clearing the check next to the color in the % Area menu.

Enable			% Area	
<input checked="" type="checkbox"/>		Red	Brightest	0%
<input checked="" type="checkbox"/>		Pink	Area	0%
<input checked="" type="checkbox"/>		Violet	Darkest	0%

- **Luminance:** Create a user-defined false color palette based on luminance values.

Note: In multi-input mode, Luminance False Color works with both the primary and secondary channels.

The Luminance False Color display replaces pixels that fall within a specified range of nits or stops values to a color that you specify. You can configure up to nine ranges. For example, you can use the Luminance False Color display to tag pixels that are within a specified HDR range.

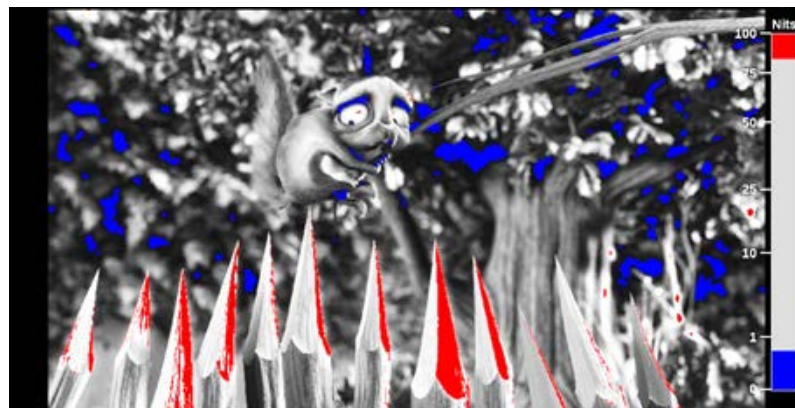

(Copyright 2008, Blender Foundation / www.bigbuckbunny.org)

The false color ranges are defined in nits or stops depending on the gamma curve set up in the input (select the **Settings** icon () and then select **Input**). If a camera-based gamma curve is set, such as S-Log2, the false color ranges are in stops. If a display-based gamma curve is set, such as SDR Narrow, the false color ranges are in nits.

Turn on Meter Overlay

In the **Luminance** menu, set **Meter Overlay** to **On** to enable the Meter Overlay in the Picture tile. The overlay shows the false color definitions in nits or stops made in the Luminance False Color table at the bottom of the menu. You can move the overlay to the right, bottom, left, or top of the image by dragging the meter with a mouse or by touch.

By default, the false colors are defined according to the BT.2408 specifications if a display-based gamma curve is set for the input, or a typical camera specification if a camera-based gamma curve is set for the input. If changes are made to the false color ranges in the Luminance False Color table, an indication that the default settings have changed is shown.

To reset the ranges to their default settings, select **Default**.

Customize False Color

The Luminance False Color table allows you to customize up to nine false color ranges as defined by a minimum and maximum nits or stops value. The pixel values are displayed in either Code Value or Percent but selecting the readout in the table header.

Specific colors can be displayed by selecting the checkbox in the **Enable** column of the table. You can change the Nits or Stops range even if the checkbox is not set.

To adjust the Nits or Stops range, select anywhere in the row you want to change. You can adjust the Minimum and Maximum value in the range using the up and down arrow keys, or select in the number field and a numeric entry keypad appears. Enter the line number and select **Enter** to close. The false colors in the Picture and the Meter Overlay are updated as adjustments are made.

If the range for one color overlaps the range for another color, the color that is higher in the table overlaps the colors lower in the table.



You can turn False Color on and off in the tile:

1. Select the **Picture** tile, which brings up a False Color setting.
2. Select the False Color option to change between on and off.

The false color shown is the most recent false color display selected in the Picture Settings menu.

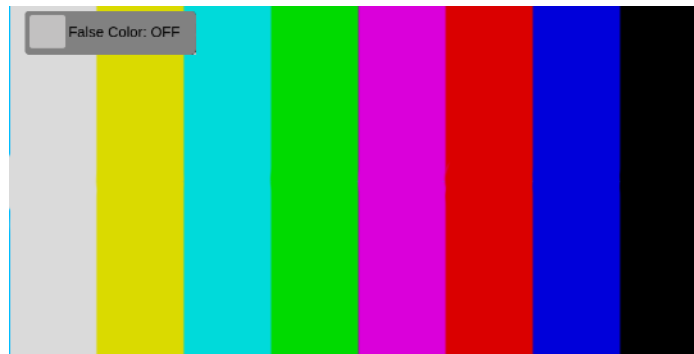

Extended Full-Screen Display

In an extended display, you can enlarge the Picture application even more than full screen. The picture expands to cover the status bar.

Note: This option is possible only with the Picture application in an extended display.

There are two ways to change between full-screen and extended full-screen mode.

- Double-tap: Each double-tap in the Picture application changes the display to the next size: from quarter-screen mode (or half-screen if it was set) to full-screen, to maximum-screen mode (the status menu is covered), and back to quarter- or half-screen mode.
- Select the icons:
 - A. In the Picture application, in the extended display, select the **Tiles** icon (🗪) to open the application bar and select the full-screen icon (🖥️).
The Picture application changes to full-screen mode.
 - B. Select the **Extended Full-Screen** icon (🖥️). The Picture application changes to extended full-screen mode.
 - C. Select the **Reduce** icon (🖥️) to return to half- or quarter-screen mode.

The following figure shows the extended display (right side) in full-screen mode.

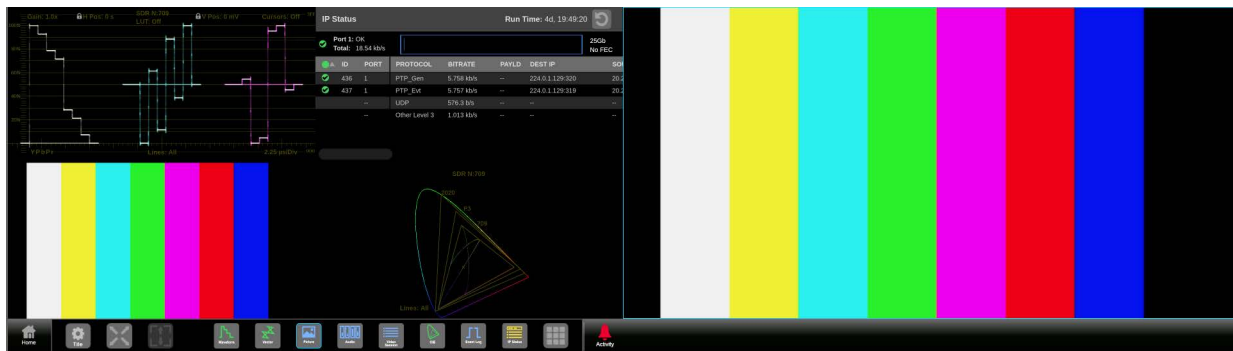

The following figure shows the extended display in extended full-screen mode.



Video Session Application

Note: In multi-input mode, Video Session works only with the primary channel.

Use this application to view various performance parameters of the SDI video signal or the decoded IP stream. Select any of the tab titles to view the associated information:
SDI Format, VPID 352, Bit Level, CRC Status, or JPEG XS.

The screenshot shows the 'Video Session' application interface. At the top, it displays 'Run Time: 0d, 19:01:08' and a 'Running' status with a play button icon. Below this, the input source is identified as 'SDI - SDI-In 1' with a resolution of '1080i 59.94 - HD SDI 422 - 292M 1.485/M Gbps'. There are four tabs: 'SDI FORMAT' (checked), 'VPID 352' (unchecked), 'BIT LEVEL' (unchecked), and 'CRC STATUS' (checked). The 'CRC STATUS' tab is active, showing a table of error statistics.

STATISTICS	STATUS	ERR FIELDS	ERR SECS	% ERR FIELDS
Y Chan CRC Error	OK	1719	746	0.0419
C Chan CRC Error	OK	1719	746	0.0419
Y Anc Checksum Error	OK	89	5	0.0022
C Anc Checksum Error	OK	215	6	0.0052

The 2110-22 JPEG XS tab shows the decoded JPEG XS metadata from a 2110-22 stream. See [2110-22 JPEG XS Tab](#) for further information.

Video Session Elements

The following elements are at the top of the Video Session application:

- **INPUT:** Shows the selected input source on the top line and shows the detected format, sample structure, and transport of the input signal on the second line.
 - **Display tabs:** Each tab has a status indicator to provide a quick view of the status of the parameters contained in each tab.
 - **SDI FORMAT:** This page shows the status of various SDI signal parameters on the input signal.
 - **VPID 352:** This page shows the status of the ST 352M VPID on the input signal. For 3G-SDI signals, VPID is required on the primary link (Link A).
 - **BIT LEVEL:** This page shows if there are any stuck bits in the input signal.
 - **CRC STATUS:** This page shows the status of CRC and Checksum errors in the video signal.
 - **2110-22 JPEG XS:** This page shows the decoded JPEG XS metadata from a 2110-22 stream. 2110-22. See the JPEG XS tab for additional information.
- **Run Time:** The instrument maintains a running monitoring session for the Video Session application. The Run Time readout displays the amount of time that has elapsed during the current monitoring session. The time is displayed as DD, HH:MM:SS. DD is number of days, HH is number of hours, MM is number of minutes, and SS is number of seconds.
- **Reset icon:** Select the **Reset** icon (🔄) to restart the monitoring session.
- **Run / Stop icons:** When the monitoring session is running (collecting error data), select the **Stop** icon (⏏) to stop the session. When the monitoring session is stopped (no error data collection and no display updates), select the **Play** icon (▶) to restart the session.

SDI FORMAT Elements

Select the **SDI FORMAT** tab to view the status of various SDI signal parameters on the input signal.

- **SAV Place Err:** Indicates if a Start-of-Active-Video Placement error has occurred.
- **EAV Place Err:** Indicates if an End-of-Active-Video Placement error has occurred.
- **Field Length Err:** Indicates if a Field Length error has occurred.
- **Line Length Err:** Indicates if a Line Length error has occurred.
- **Line Number Err:** Indicates if a Line Number error has occurred.
- **Ancillary Data:** Indicates if Ancillary Data is present in the video signal. The displayed values are either Present or None for SD signals, or Y and C Present and None for HD and 3 Gb/s signals.
- **Statistics:** This section of the display shows the status and statistical values for certain errors. For information about the errors in this section, view the help file in the instrument: When the Video Session is active in a tile, select the HELP button.
- **Status:** Shows the status of the associated error as OK, Invalid, Missing, or Error.

VPID 352 Tab

Select the VPID 352 tab to view the VPID values of the ST 352M payload. For 2110 inputs, VPID is sent over the lowest-numbered 2110-40 stream.

For 3G-SDI signals, VPID is required on the primary link (Link A).

Note: If input parameters such as Gamma Curve, Color Gamut, or Structure are set to Auto, VPID 352 (if present) is used to set them.

Video Session		Run Time: 1d, 04:32:47		Running	
Input: SDI - SDI-In 3 2048x1080p 59.94 - YCbCr 422 10b - 425M-B 2.970/M Gbps					
SDI FORMAT	VPID 352	BIT LEVEL	CRC STATUS		
Link A1	8Ah 4Ah 40h 1h	BYTE 1 10001010	SMPTE 425.1 Lvl B (1125)		
Link A2	8Ah 4Ah 40h 41h	BYTE 2 01001010	Transport	interlaced	
			Picture	progressive	
			Transfer	SDR	
			Picture Rate	59.940	
		BYTE 3 01000000	Aspect Ratio	Unknown	
			H pixel	2048	
			Color	BT709	
			Sampling Structure	YCbCr 4:2:2	
		BYTE 4 00000001	Luma Color Difference	YCbCr	
			Channel assignment	1	
			Bit Depth	10-bit	

Note: Full- and half-screen modes show the Binary values (shown in the example, under BIT LEVEL), which are hidden in 1/4-screen mode to present a more compact view.

The VPID 352 tab consists of two panes:

- **Left pane:** Shows the presence of a ST 352M payload. The number of data streams determine the number of links, with the VPID values shown in hex. You may select a link to display the decoded VPID information in the right pane.
- **Right pane:** Contains the decoded VPID of the selected link. The VPID contains 4 bytes of data, and these show the transport standard, picture, frame rate, sampling structure, and bit depth information. Depending on the standard, different information might be present, such as Aspect Ratio, Transfer Characteristic, Colorimetry, H Pixel, and Channel Assignment.

BIT LEVEL Tab

Select the **BIT LEVEL** tab displays any stuck bits in the input signal.

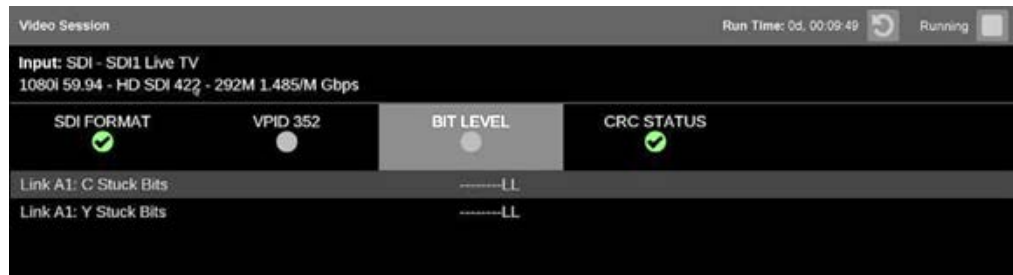

- **Y Stuck Bits:** Displays which of the luminance video bits are stuck. If the readout is “---”, then none of the bits are stuck.

Note: For 8-bit video, because the unused bits are always low, “-----LL” is displayed when no other bits are stuck.

- **C Stuck Bits:** Displays which Chrominance video bits are stuck. If the readout is “---”, then none of the bits are stuck.

CRC STATUS Tab

Select the **CRC STATUS** tab to view the status of CRC and Checksum errors in the video signal.

STATISTICS	STATUS	ERR FIELDS	ERR SECS	% ERR FIELDS
Y Chan CRC Error	OK	2	1	0
C Chan CRC Error	OK	2	1	0
Y Anc Checksum Error	OK	0	0	0
C Anc Checksum Error	OK	0	0	0

Note: The instrument uses the RP 165 standard for error checking. For HD and 3 Gb/s signals, the CRCs change on every video line.

- **Y Chan CRC Error:** Displays the status of the Y channel embedded CRC (Cyclical Redundancy Check) that was calculated for the video signal. Using a known test signal, the CRC status can be used to verify integrity through a system. An error means that the Y Channel embedded CRC value does not match the calculated CRC value, which indicates that a transmission error has occurred.
- **C Chan CRC Error:** Displays the status of the C channel embedded CRC (Cyclical Redundancy Check) that was calculated for the video signal. Using a known test signal, the CRC status can be used to verify integrity through a system. An error

means the C Channel embedded CRC value does not match the calculated CRC value, which indicates that a transmission error has occurred.

- **Y Anc Checksum Error:** Displays the status of the Y channel ancillary embedded checksum value that was calculated for the video signal. Using a known test signal, the checksum status can be used to verify integrity through a system. An error means the Y Channel embedded checksum value does not match the calculated checksum value, which indicates that a transmission error has occurred.
- **C Anc Checksum Error:** Displays the status of the C channel ancillary embedded checksum value that was calculated for the video signal. Using a known test signal, the checksum status can be used to verify integrity through a system. An error means the C Channel embedded checksum value does not match the calculated checksum value; this indicates a transmission error has occurred.
- The CRC Status display is also divided into four columns:
 - **Status:** Shows the status of the associated error:
 - **OK:** No error is currently detected.
 - **Invalid:** The data for the item is currently invalid.
 - **Missing:** The data for the item is currently missing.
 - **Error:** The associated error is currently in an error state.
- **Err Fields:** The number of fields, since the last reset, that contained at least one error.
- **Err Secs:** The number of seconds, since the last reset, that contained at least one error.
- **% Err Fields:** Shows a calculated number of the percentage of all fields since the last reset that contained at least one error.

2110-22 JPEG XS Tab

Select the 2110-22 JPEG XS tab to view the decoded JPEG XS metadata of the ST 2110-22 stream. The metadata includes common video attributes such as resolution, frame rate, sample structure, range, timecode, and colorspace.

Note: Decoding 2110-22 requires the MPSPD-JPXS license.

The screenshot shows a 'Video Session' window with a 'Run Time: 0d, 01:43:05' and a 'Running' status. The input is 'IP - NMOS Input 5 3840X2160p 59.94 - YCbCr 422 10b - 2082.10-1 11.88/M Gbps'. Three tabs are visible: 'VPID 352', 'BIT LEVEL', and '2110-22 JPEG XS'. The '2110-22 JPEG XS' tab is active, displaying the following metadata:

Payload Bitrate	750 Mbps	Transfer	709
Decoded Bitrate	9.94 Gbps	Range	Narrow
Compression Ratio	13.258	Color Space	BT709
Width 3840	Height 2160	Timecode	11:53:38:45
Frame Rate	60p	Profile	High 444.12
Bit Depth	10	Level Signaling	4k-2
Sample Structure	YCbCr 4:2:2	Sublevel Signaling	Sublevel6bpp

The tab also displays metadata specific to JPEG XS:

- **Payload Bitrate** describes the total bitrate of the undecoded 2110-22 stream.
- **Decoded Bitrate** reports the bitrate of the uncompressed video data after it has been decoded.
- **Compression Ratio** is the ratio between the decoded bitrate and the payload bitrate.
- **Profile** specifies the JPEG XS profile used for encoding.
- **Level Signaling** indicates the level of the JPEG XS codec. This is often used to define the maximum resolution and frame rate.
- **Sublevel Signaling** provides more information about constraints within the specified level. This is often used for specifying the nominal bits per pixel for the encoded image.

Audio Application

Note: In multi-input mode, Audio works only with the primary channel.

The Audio application provides a level-meter display with multiple ballistic settings, and optional Audio Session and Lissajous with Channel Correlation displays. Audio Session shows instantaneous measurements of the level meters and the Lissajous and Channel Correlation displays show audio phase information. Dolby E decoding can be performed on a specified SDI input channel pair.

Note: The Lissajous, Channel Correlation meter, and Audio Session displays require software option MP2-AUD. Dolby E decoding requires option MP2-DLBY. The 32-channel audio support requires option MP2-FMT-8K.

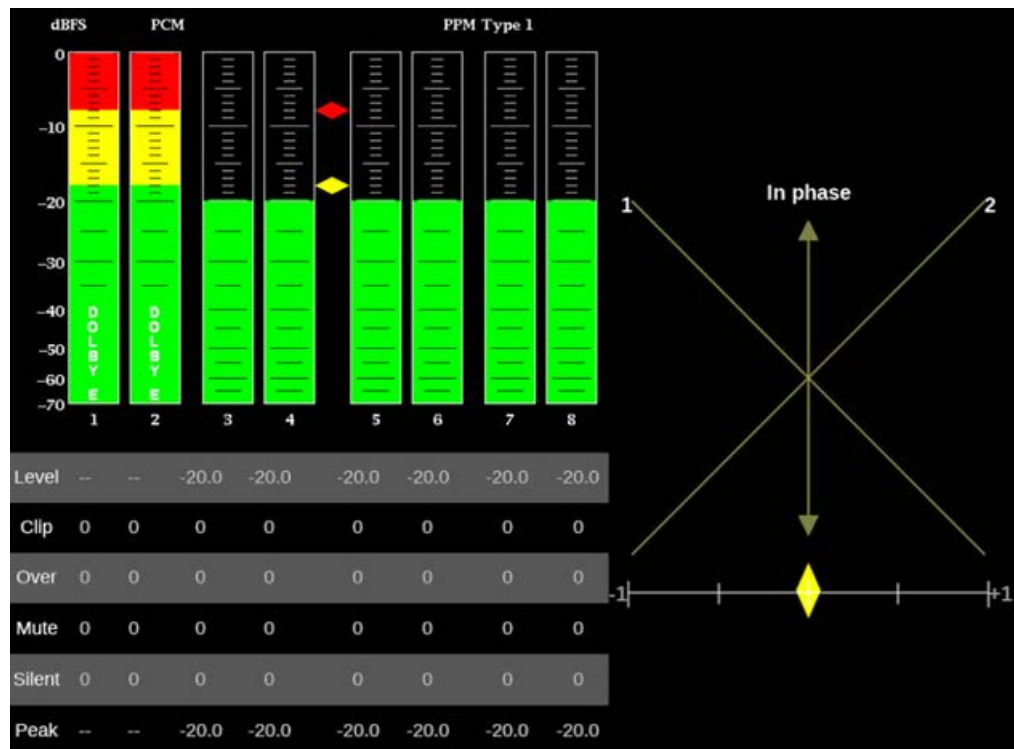

Configure Audio

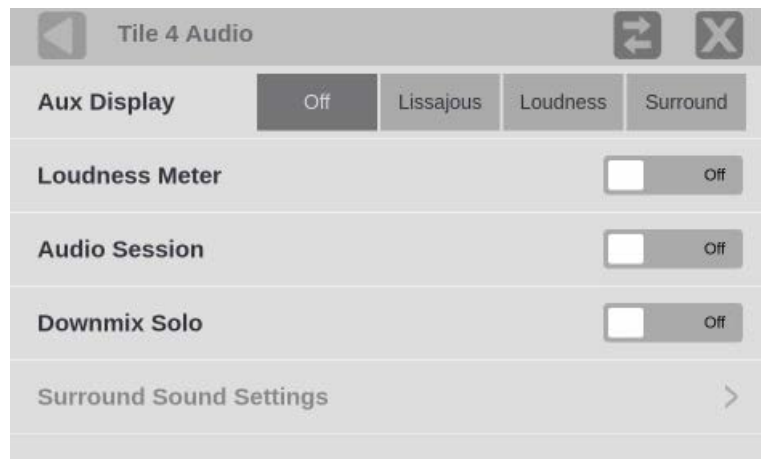

This section describes the parts of the Audio tile and the information available, such as level meters and the Lissajous display. It also explains the measurements in those displays.

Level meters are the vertical bar graphs. The height of the bar indicates the amplitude of the audio program in the corresponding input channel. The meter levels are color coded based on their relationship to the Test level and Peak Program level indicators:

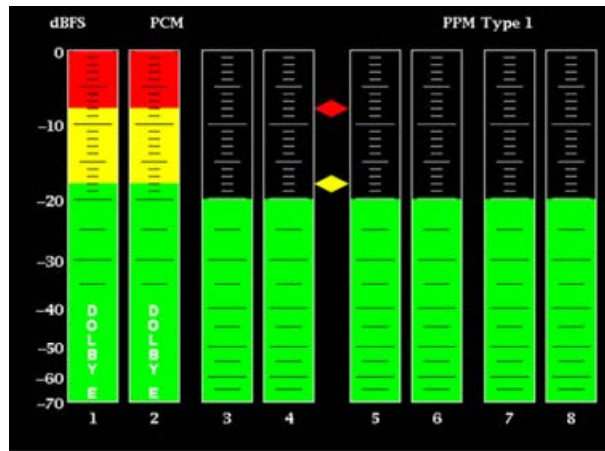



- The meter bars are displayed below the Test level in green.
- Between the Test level and the Peak Program level, the meter bars are displayed in yellow.
- Above the Peak Program level, the meter bars are displayed in red.

For details about changing the Test level, see [Test Level \(dBFS\)](#).

For details about changing the Peak Program level, see [Peak Program Level \(dBFS\)](#).

To configure the Audio settings:

1. Select the **Tiles** icon ().
2. Select the tile with the Audio application.
3. Select the **Tile** icon ().

Note: To move the settings left or right, select the **Move** icon () in the Settings menu header.

4. 5.1 Channel Order changes the order the right and center channels in any 5.1 surround program are displayed in the level meters. To configure the order:

- A. Select the **Settings** icon ().
- B. Select **Audio**.

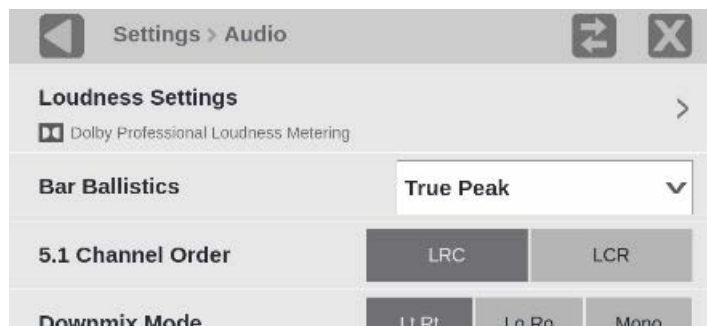

- C. In the **5.1 Channel Order** section, select **LCR** or **LRC**. The level meter reorders to left-center-right or left-right-center.

Note: This setting affects all 5.1 surround programs. If you select a second 5.1 surround program, both programs are set to LCR or LRC.

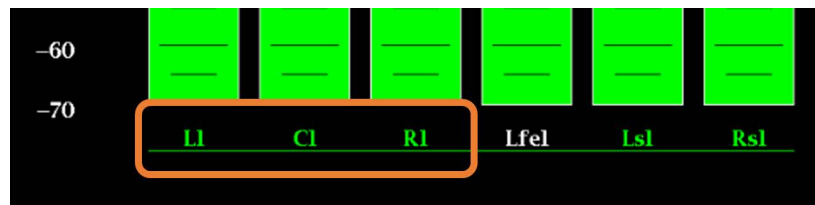
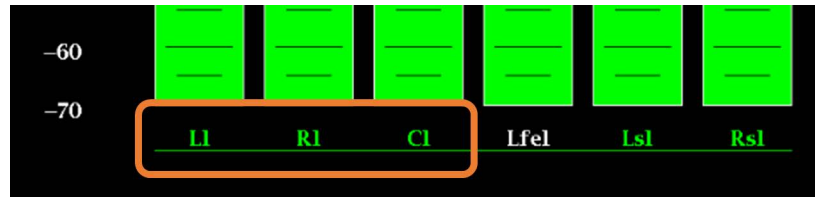

- 5. Ballistics displays the selected ballistics for the level-meter dynamic response above the level meter, on the left. To change the ballistics:
 - A. Select the **Settings** icon (⚙️) and then select **Audio**.
 - B. From the **Bar Ballistics** list, select **True Peak**, **PPM Type1**, or **PPM Type2**.

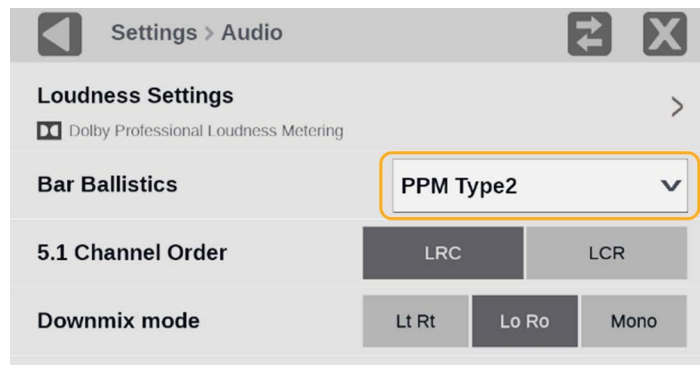

Test Level and Peak Program Level Indicators

The arrows or diamonds next to the level bars indicate the Test level (in yellow) and Peak level (in red) limits for the display. Test level is also known as Reference level or Line-up level.

Level Meter Scale and Units

By default, the units are in dB relative to full scale (dBFS). The 0 dB mark is digital Full scale.

Lissajous Display

The phase of a selected pair of audio channels is plotted on a soundstage plot. Soundstage plots the two channels at 45-degree angles, with the mono combination appearing on the vertical axis, much like a left-right image in a studio.

To select the audio channel pair to plot on the Lissajous display, select the **Volume** icon () on the status bar and choose from the list of available channel pairs.

Channel Correlation Meter

Displays the channel correlation under the Lissajous display.

- For identical or highly correlated signals, the indicator is white and moves to the far right (+1).
- For highly correlated signals, the indicator is green and moves to the right (towards +1).
- For uncorrelated signals, the indicator is yellow and tends to stay in the middle (around 0).
- For anti-correlated signals (one goes up when the other goes down), the indicator is red and moves to the left (towards -1).

Level Meter Bar Messages

This instrument displays information within the level meter bars. These are messages that can appear and are shown in order of priority:

- **UNLOCKED:** The instrument is not locked to an incoming signal on the indicated input channel. Data cannot be decoded and all data and other errors are ignored. This means that if an input is selected, nothing recognizable is present on the input, or if embedded audio is selected, the VIDEO input is unrecognizable.
- **PARITY:** The incoming subframe does not have even parity as specified by the digital audio standards. The data sample is unreliable and is ignored. The level meters and Lissajous display treat the sample as a zero sample.
- **CRC ERR:** The CRC code in the channel status packet is incorrect. Sometimes the CRC code is set to zero, indicating that the signal is missing; when this is the case, this message is not displayed.
- **MUTE:** The number of consecutive all-zero samples equals or exceeds 10.
- **SILENCE:** The signal is below -70 dB for 5 seconds or more.
- **V BIT:** Indicates that the Validity bit is set high for one or more data samples. In the AES/EBU standard, a set validity bit indicates that the sample is not suitable for conversion to audio. By default, the level meter bars and Lissajous
- **NOT PRESENT:** Indicates that an audio bar is not present in the current audio input. For example, if a Dolby Digital input has a coding mode indicating a reduced number of channels.
- **DOLBY D, DOLBY D+, DOLBY E, DOLBY ED2:** Indicates that the specified type of Dolby encoded audio is present on the channel or channels.

- **CLIP:** Indicates the audio level was at the digital code for the maximum amplitude for ten consecutive samples.
- **OVER:** Indicates when the audio amplitude (level) exceeds the silence level threshold for the specified duration. The default is -2dB for 1 second. To change the alarm settings, see [Configure Alarms](#).

Note: The 32-channel audio is supported with MP2-FMT-8K license. In 8K video with Quad 12G-SDI connection, the first 16 channels (of 32 channels) come from the link A1 and the next 16 channels come from the link B1. To view the 32-channel audio bars, you must select the two Audio applications in two tiles.

Lissajous Display

The Lissajous display is a visual of a user-specified pairing of channel inputs with a channel correlation meter.

To turn on the Lissajous display, in the **Aux Display** section, select **Lissajous**.

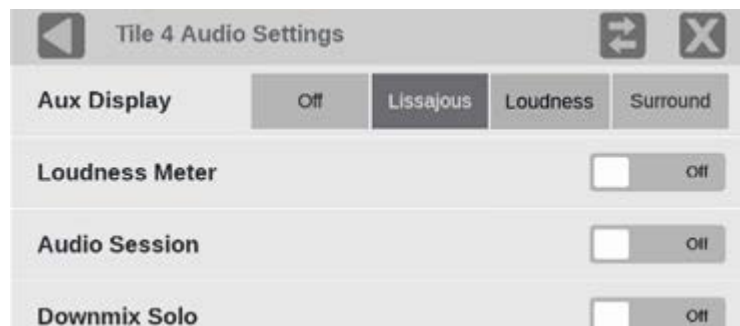

The Lissajous display appears to the right of the Audio bars.

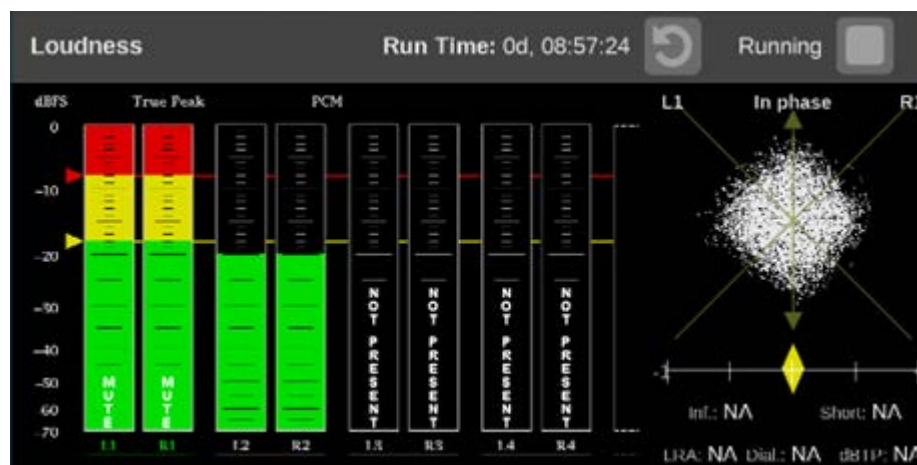

Loudness Display

The Loudness display is a visual of the audio loudness measurements. The Loudness display allows you to view audio loudness values associated with audio loudness measurements. This instrument maintains a running audio loudness session.

Note: The Loudness measurement is available for mono, stereo, 5.1, and 7.1 multichannel audio programs.

To turn on the Loudness display, in the **Aux Display** section, select **Loudness**.

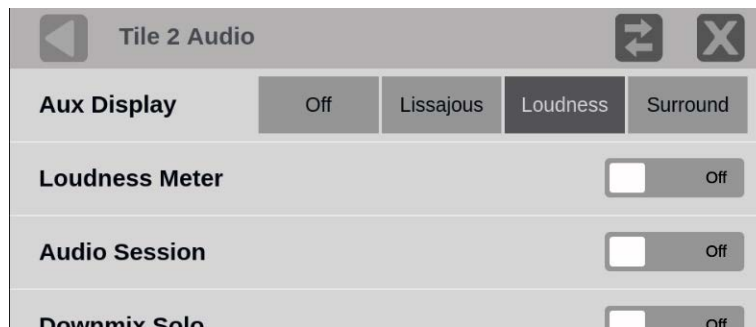

The Loudness Display appears to the right of the audio bars.

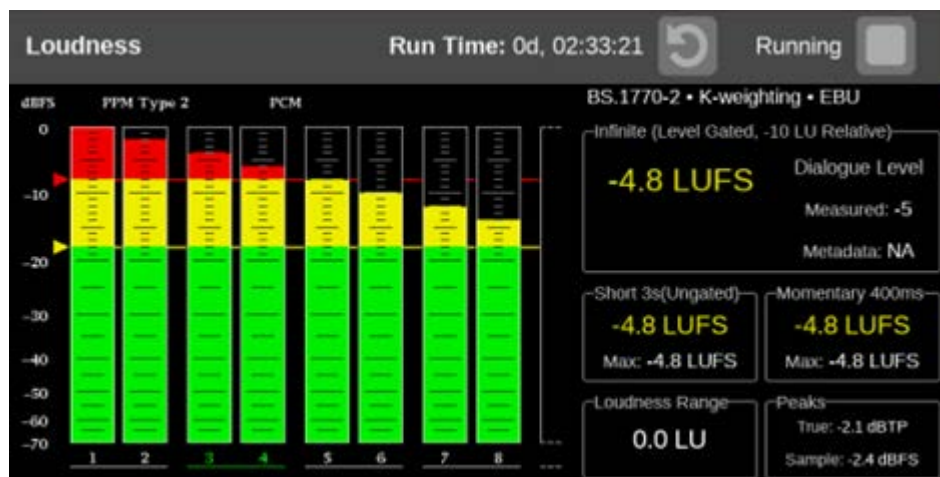

Note: The Audio tile appearance can vary based on the selection of other auxiliary audio displays, including Audio Session or Lissajous Display.

Configure the Loudness Display

1. Select the **Settings** icon (⚙️).
2. Select **Audio**.
3. Select **Loudness Settings**.

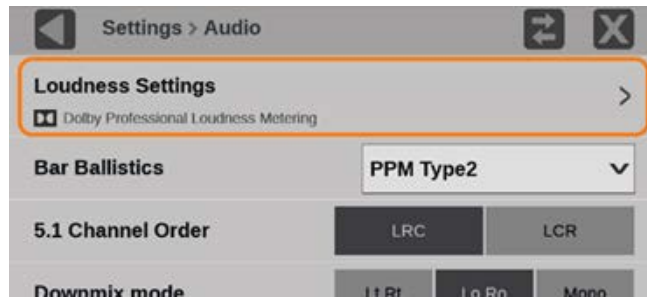

4. Load a standard:

- Select **EBU R128:2014** or **ATSC A/85:2013** for a predefined loudness metering configuration. This setting also changes the full-scale units between LUFS and LKFS according to the standard.
- Or customize the Loudness Display configuration according to the metering measurement goal or audio content type (dialogue, music, or movie). The Configuration Parameters for Loudness Display table lists the available configuration parameters.

Configuration Parameters for Loudness Display

Parameter	Available Configurations	Notes
LOUDNESS METERING MODE	BS.1770-1 with DI ¹ , BS-1770-2 with DI, Leq(A) with DI, BS.1770-2 w/o DI	Mode implies a weighting function (A-weighting or K-weighting) and gating technique(s) when performing loudness metering.
Speech Threshold (%)	0 to 100%	Threshold above which the Speech Gating is turned on in the DI-enabled metering modes.
Loudness Ballistics	Short Average, Long Average, EBU R128 M	Sets the response of the Loudness meter bar.
TARGET LOUDNESS	0 to -31LKFS with 0 to 10LU tolerance	Sets the intended target loudness (to be highlighted in the Loudness display with appropriate color code).
LOUDNESS THRESHOLDS	Loud is 0 to -30 and Quiet 0 to -60 Full Scale Loudness	Sets the limits to trigger in-bar status for quiet and loud level.

Configuration Parameters for Loudness Display

Parameter	Available Configurations	Notes
Short-Term Gating Window	EBU R128 (3s), Legacy (10s)	Duration of the sliding windows for short-term loudness measurement.
Full-Scale Units	LKFS or LUFS	Region specific selection; has no effect on measurement.
TRUE PEAK DC Block and Emphasis Filter	Enable or Disable	DC Block simulates the effect of downstream devices that remove DC. The Emphasis Filter compensates for dispersion effects from Nyquist filters in the broadcast chain that make it difficult to measure and control the peak levels of high-frequency signals.

¹ Dialogue Intelligence enabled

Note: The dialogue intelligence algorithm in PRISM introduces a latency of 2.048s in the effective measurement of the short-term and infinite Loudness. Other Loudness measurement parameters are not affected by the latency.

The Loudness measurements are updated every 500 ms in the user interface.

Maximum short-term Loudness level can be considered as an alternative to using Loudness range for short audio clips.

Change Channels the Loudness Meter Measures

Select the correct program labels at the bottom of the level bars (green letters mean it is selected). The Loudness meter measures the levels based on that audio program.

Note: Changing the selected Audio program that the Loudness meter measures changes the headphones or speaker pair, and changing the headphones or speaker pair changes the selected Audio program the Loudness meter measures. Changing the Audio program also resets the Loudness measurement.



Note: The low-frequency effects channel (Lfe1) in 5.1 and 7.1 is not used in the loudness calculations.

Loudness Meter Labels

- The labels at the bottom of the audio bars (marked as 1) in this example means it is program 2 and there is a left and a right channel.
- The label at the bottom of the Loudness bar (marked as 2) means it is measuring program 2.
- The green letters in the status bar (marked as 3) mark the channels the Loudness display is measuring and where they are in the channel series.

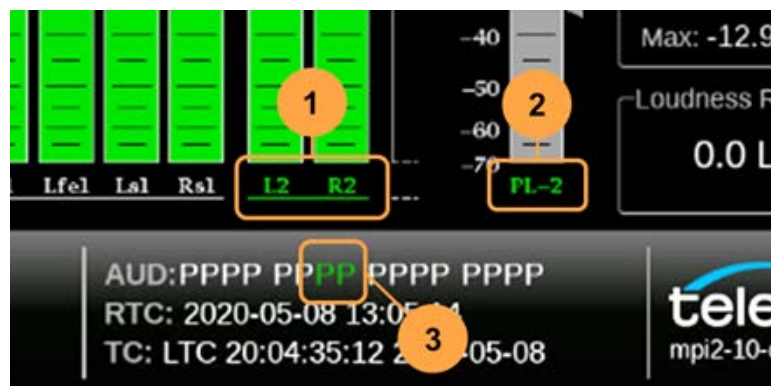

Loudness Meter Controls

- To start and stop the loudness meter: select the **Play** (▶) button or **Stop** (◻) button.
- To reset the measurement run time: select the **Reset** button (↺).

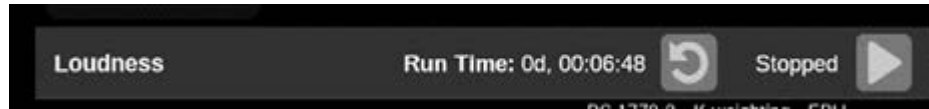

- You can use the controls to independently stop, start, and reset the Audio Session and Loudness measurements.



Surround Display

To turn on the Surround display:

1. In the **Aux Display** section, select **Surround**.

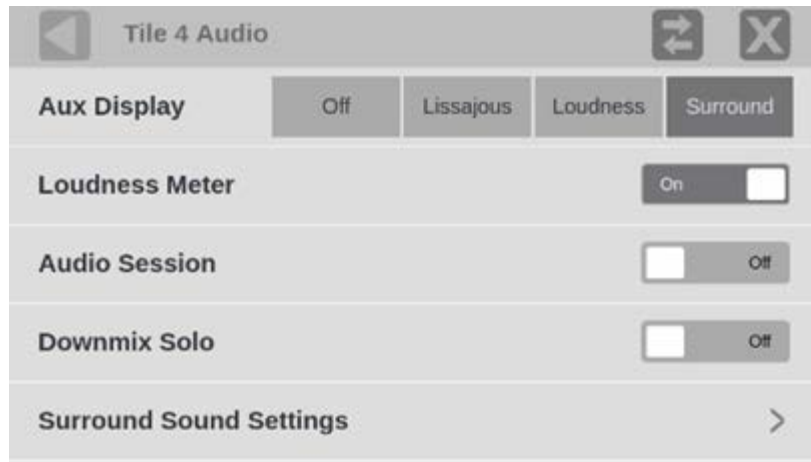

2. Turn on the Loudness Meter to monitor the loudness level, if needed; set the **Loudness Meter** to **On**.
3. Set Loudness Metering to the preferred type.
 - A. Select the **Settings** icon (⚙️).
 - B. Select **Audio** and then select **Loudness Settings**.
 - C. In the **LOUDNESS METERING MODE** section, select an option:
 - ◆ **BS.1770-1 plus Dialogue Intelligence**
 - ◆ **BS.1770-2 plus Dialogue Intelligence**
 - ◆ **BS.1770-2**
 - ◆ **Leq(A) plus Dialogue Intelligence**

Note: A-weighting—Leq(A)—biases the response toward that of human hearing.

4. Set the surround settings:

- A. In the Audio tile settings, select **Surround Sound Settings**.
- B. In the **Analyzer Layer** section, select the level(s) to view:
 - ◆ **Main Bed:** the lower level of audio;
 - ◆ **Upper Bed:** the top level of audio; or
 - ◆ **Both:** Main Bed Upper Bed together.
- C. In the **Phantom Source Indicator** section, select **Main Bed** or **Upper Bed**.
- D. If needed, set the **Dominance Indicator** to **On**.
- E. If needed, set the **Immersive Dominance Indicator** to **On**.

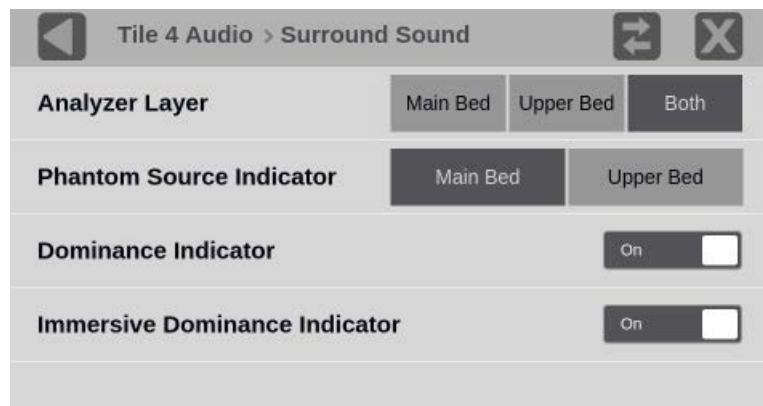

Surround Display Elements

You can monitor the relative loudness of the individual elements rendered in a surround-sound listening environment. Check the surround sound display for performance parameters and indicators.

5.1 Surround Sample

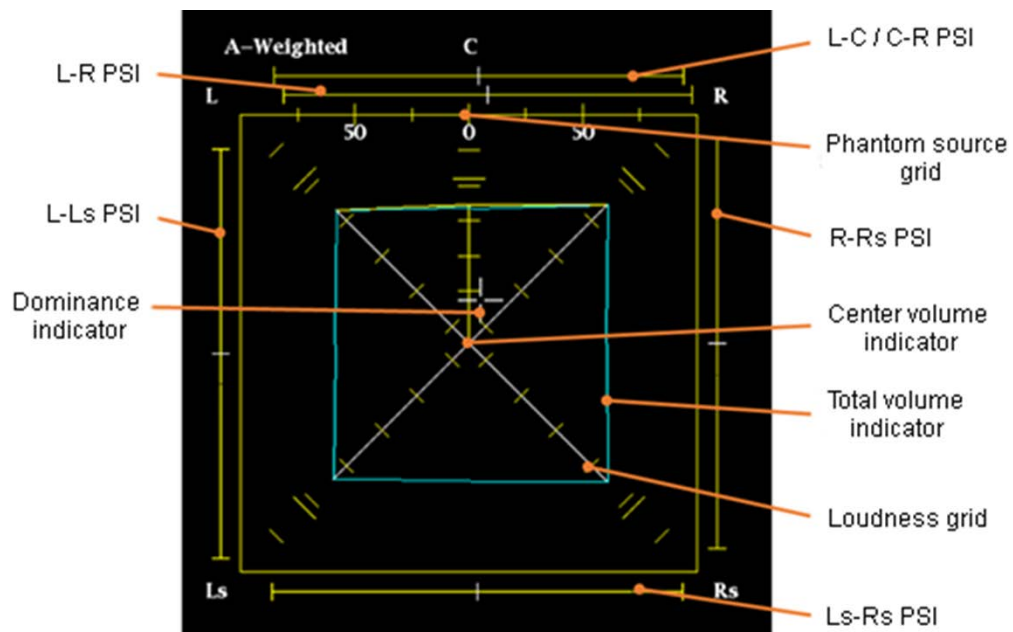

Note: The Audio Surround Sound display is provided under license from RTW GmbH & Co. KG.

Phantom Sound Indicator (PSI) bars are on each side of the surround sound display. The bars indicate the location of potential phantom sound sources formed by adjacent channels. The white tick marks on these moving bar indicators show the phantom source locations. The bar length indicates the correlation between the adjacent channels. A short-to-medium length green bar indicates positive correlation between the channels, forming a localized phantom sound source located at the white tick mark. The bar grows to full length and changes color to yellow as the correlation moves to zero, indicating a wide, non-localized sound image. The bar changes color to red for adjacent channels with significant negative correlation. For negative correlations, the ends of the PSI for the L and R channels continue to grow at a 45-degree angle while the other PSIs remain at full length.

- **L-R PSI:** Left-to-right phantom sound indicator bar.
- **L-Ls PSI:** Left-to-left surround phantom sound indicator bar.
- **Dominance indicator:** Shows the position of the subjectively perceived acoustic focal point.
- **L-C / C-R PSI:** Left-to-center and center-to-right phantom sound indicator bar.
- **Phantom source grid:** A measurement of 50 is the center of the left-to-center or center-to-right scales.
- **R-Rs PSI:** Right-to-right surround phantom sound indicator bar.
- **Center volume indicator:** This displays the sound volume of the center channel as a vertical yellow bar between the L and R channels, and connects the ends of the L, C, and R audio level indicators with straight lines.
- **Total volume indicator:** This is the cyan polygon formed by connecting the level indicator end points, showing the total sound volume of the L, R, Ls, and Rs channels. Each connecting line bends away from the center if the two signals have a positive correlation, bends toward the center if the signals have a negative correlation, and do not bend if the signals are uncorrelated.
- **Loudness grid:** This is the ruled scale, radiating from the center, on which the level indicators register their audio level and balance. The scale has tick marks at 10 dB intervals. An additional tick mark indicates the –18 dB level. The –18 dB and –20 dB levels are typically used for aligning audio levels.
- **Ls-Rs PSI:** Left surround-to-right surround phantom sound indicator bar.

- **Rbs-Lbs PSI:** Right back surround-to-left back surround phantom sound indicator bar.
- **L-C / C-R PSI:** Left-to-center and center-to-right phantom sound indicator bar.
- **Phantom source grid:** A measurement of 50 is the center of the left-to-center or center-to-right scales.
- **R-Rs PSI:** Right-to-right surround phantom sound indicator bar.
- **R-Rbs PSI:** Left-to-left back surround phantom sound indicator bar.
- **Center volume indicator:** This displays the sound volume of the center channel as a vertical yellow bar between the L and R channels, and connects the ends of the L, C, and R audio level indicators with straight lines.
- **Rs-Rbs PSI:** Left surround-to-left back surround phantom sound indicator bar.
- **Total volume indicator:** This is the cyan polygon formed by connecting the level indicator end points, showing the total sound volume of the L, R, Ls, and Rs channels. Each connecting line bends away from the center if the two signals have a positive correlation, bends toward the center if the signals have a negative correlation, and do not bend if the signals are uncorrelated.
- **Loudness grid:** This is the ruled scale, radiating from the center, on which the level indicators register their audio level and balance. The scale has tick marks at 10 dB intervals. An additional tick mark indicates the -18 dB level. The -18 dB and -20 dB levels are typically used for aligning audio levels.

7.1.4 Surround (Upper Bed) Sample

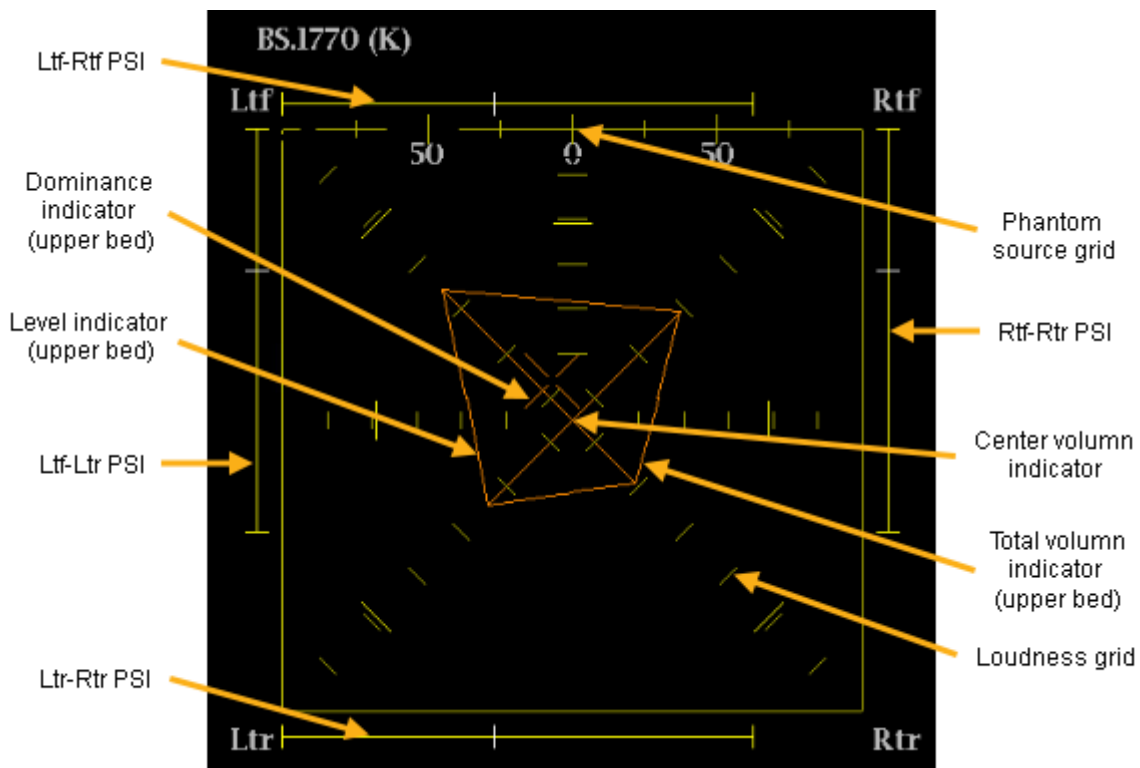

Note: If in the Analyzer Layer, the Upper Bed layer (or Both) is selected but there is no upper bed data, as in non-immersive surround programs like 5.1 or 7.1, the upper bed surround display is empty (no orange display) because there is no upper bed audio data.

Phantom Sound Indicator (PSI) bars are on each side of the surround sound display. The bars indicate the location of potential phantom sound sources formed by adjacent channels. The white tick marks on these moving bar indicators show the phantom source locations. The bar length indicates the correlation between the adjacent channels. A short-to-medium length green bar indicates positive correlation between the channels, forming a localized phantom sound source located at the white tick mark. The bar grows to full length and changes color to yellow as the correlation moves to zero, indicating a wide, non-localized sound image. The bar changes color to red for adjacent channels with significant negative correlation. For negative correlations, the ends of the PSI for the L and R channels continue to grow at a 45-degree angle while the other PSIs remain at full length.

- **Ltf-Rtf PSI:** Left top front-to-right top front phantom sound indicator bar.
- **Dominance indicator (upper bed):** Shows the position of the subjectively perceived acoustic focal point. The orange crosshair is specifically for the main bed data.
- **Level indicator (upper bed):** Shows the position of the subjectively perceived acoustic focal point for the upper bed of audio data.
- **Ltf-Ltr PSI:** Left top front-to-Left top rear surround phantom sound indicator bar.
- **Ltr-Ltr PSI:** Left top rear-to-Right top rear surround phantom sound indicator bar.
- **Phantom source grid:** A measurement of 50 is the center of the left-to-center or center-to-right scales.
- **Rtf-Rtr PSI:** Right top front-to-Right top rear surround phantom sound indicator bar.
- **Center volume indicator:** This displays the sound volume of the center channel as a vertical yellow bar between the L and R channels, and connects the ends of the L, C, and R audio level indicators with straight lines.
- **Total volume indicator (upper bed):** This is the orange polygon formed by connecting the level indicator end points, showing the total sound volume of the L, R, Ls, and Rs channels. Each connecting line bends away from the center if the two signals have a positive correlation, bends toward the center if the signals have a negative correlation, and do not bend if the signals are uncorrelated.
- **Loudness grid:** This is the ruled scale, radiating from the center, on which the level indicators register their audio level and balance. The scale has tick marks at 10 dB intervals. An additional tick mark indicates the -18 dB level. The -18 dB and -20 dB levels are typically used for aligning audio levels.

7.1.4 Surround (Both Beds) Sample

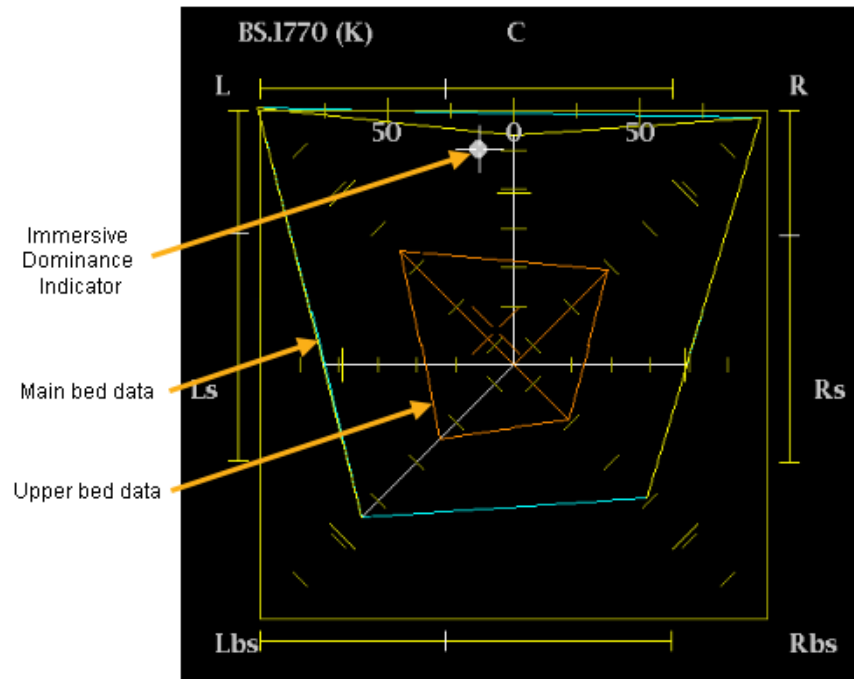

Note: In the Analyzer Layer, the Both layer is selected, but there is no upper bed data, as in non-immersive surround programs like 5.1, or 7.1, the upper bed surround display is empty (no orange display) because there is no upper bed audio data.

- **Immersive Dominance Indicator:** Shows the position of the subjectively perceived acoustic focal point of all data. The dot is visible only when both beds are shown.
- **Main bed data:** For details of the display, see [7.1.4 Surround \(Main Bed\) Sample](#).
- **Upper bed data:** For details of the display, see [7.1.4 Surround \(Upper Bed\) Sample](#).

Surround Display Usage Notes

The displays shown here are examples of how the surround sound waveform appears for some typical 5.1 surround signals. Similar principles apply to 7.1 signals, and to 5.1.4 and 7.1.4 main bed and upper bed signals.

Example 1: Shows uncorrelated signals with the same level in the L, C, R, Ls, and Rs channels.

Note: PSI are yellow, showing uncorrelated audio between the channels.

Example 2: Shows a sine wave test tone with the same level in the L,C, R, Ls, and Rs channels. All signals are in phase, creating white marks for the phantom source indicators mean that each channel has the same amplitude and frequency.

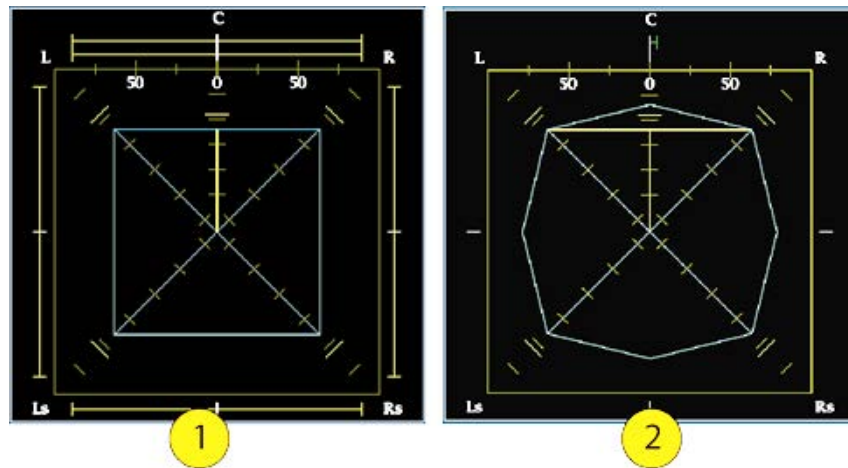

Example 3: This is the same as example 2, with the exception that Channel L is out of phase.

Note: The PSIs are in red for L-R, L-Ls, and L-C.

Example 4: Shows the surround sound program with strong center-channel presence, typically from high dialogue audio levels compared to other channels.

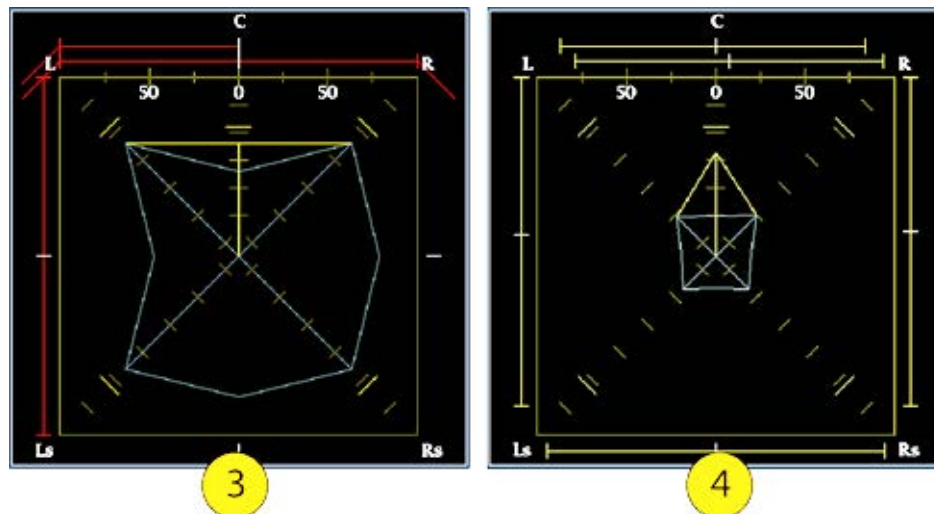

Example 5: Shows a surround sound program with weak center-channel presence, likely with a lower dialogue level compared to other channels.

Example 6: Shows a monaural signal in channels Ls and Rs, creating a phantom source in the center, as in a 5.1 surround sound system. Typically a mix could contain a copy of the L and R channel at a lower level in the Ls-Rs to create a pseudo surround mix. The white marks mean a monaural channel for Ls and Rs. The other channels are uncorrelated.

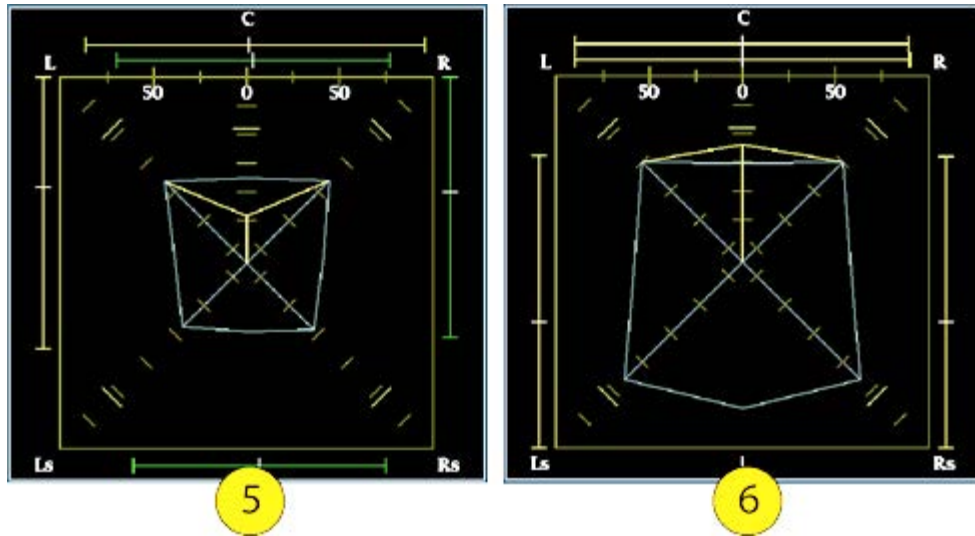

Loudness Meter

The Loudness meter is a part of the Audio application in PRISM, and it is configured in the main Settings menu. The Audio Loudness Meter allows you to view audio loudness values associated with audio loudness measurements. This instrument maintains a running audio loudness session.

To turn on the audio loudness values, set **Loudness Meter** to **On**.



The Loudness Meter appears to the right of the audio bars.

Note: Loudness measurements are not supported for more than eight channels, so the Loudness Meter does not function with 5.1.4 or 7.1.4 programs.

PRISM supports Audio Loudness Alarms. Changing the active audio program will reset the Infinite Loudness measurements. So you must stop the Loudness measurements in the audio application if you want to listen to the audio output, or measure the loudness of a different audio program.



Audio Session

Audio Session consists of several performance parameters for an overview of the audio input signal.

To turn on the audio signal overview, set **Audio Session** to **On**.



The Audio Session appears below the audio bars.



Downmix Solo

Downmix Solo allows you to select any one channel of a downmixed 5.1 or 7.1 stream and listen to it separately. This helps to isolate and identify an unexpected noise in a stream.

To use Downmix Solo:

Note: If you have an original MPI or MPX upgraded with a 25 Gb media board, see [Access Downmix Control for Input 2110-30 with Multiple Audio Streams](#) to set up the instrument for downmix.

1. In the **Audio Settings**, set **Downmix Solo** to **On**.

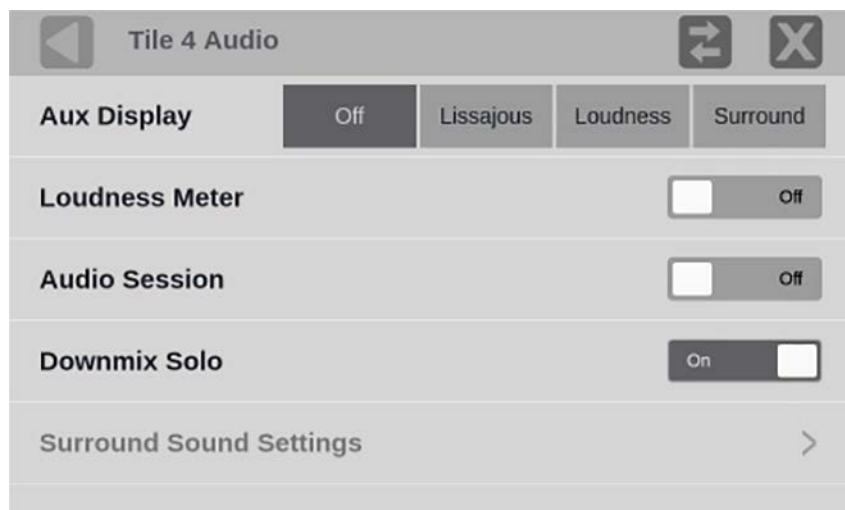

2. Select the **Volume** icon (🔊) in the status bar.
3. In the volume controls, select the **downmix** button.



4. Select the **Home** icon (🏠) to close the volume controls.
5. Select a channel to isolate in the Audio application:
 - To change the solo channel, select another channel in the downmixed stream.
 - To return to the entire downmixed stream (without turning Downmix Solo off), select the highlighted channel again.

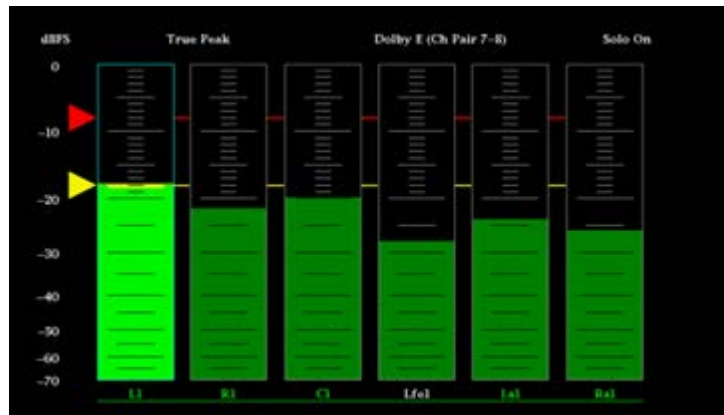

Dolby Status Application

Note: In multi-input mode, Dolby Status works only with the primary channel.

Dolby Status supports all Dolby metadata for the currently monitored input can be viewed in the Dolby Status application. The application tile indicates if Dolby audio is not available in the currently monitored input.

Note: The Dolby Status application requires software options MP2-AUD or MP2-DLBY.

If the instrument has Dolby monitoring capabilities, it can decode and monitor audio signals that are based on Dolby digital surround sound formats. These formats are Dolby D (AC-3)/D Plus (E-AC-3) compression (designed for distribution) and Dolby E compression (designed for production).

To refresh the Dolby Status data, select the **Refresh** icon (🔄) at the top of the Dolby Status tile.

If information in the Dolby Status page should have updated, but has not, for example the Program Desc Text has not updated, the **Refresh** icon will reload the data.

The sample shows Dolby D data.

Dolby Status		Program 1	
Dolby Format	Dolby D	Dolby Surround Mode	Unknown
Channel Mode	3/2 L	Copyright Bit	Yes
Metadata Source	AES Embedded 9-10	Original Bitstream	Yes
Dolby Data Rate	384 kbps		
Bitstream Mode	Complete Main		
Dolby Sample Rate	48 kHz		
DYNAMIC RANGE PARAMETERS		EXTENDED BSI	
Dialogue Level	-23 dB	Preferred Stereo Dmix	Not Indicated
Program Loudness		Lt/Rt Center Mix Lvl	-3 dB
Average Loudness		Lt/Rt Surrnd Mix Lvl	-3 dB
Line Mode Cmpr	Unknown	Lo/Ro Center Mix Lvl	-3 dB
RF Mode Cmpr	-0.28 dB	Lo/Ro Surrnd Mix Lvl	-3 dB
		Surround EX Mode	No
RF Overmod Prot	Disabled	Headphone Mode	Unknown
Center Mix Lvl	-3 dB	A/D Converter Type	STD
Surround Mix Lvl	-3 dB		
Mixing Level	105.00 dB	SMPTE Timecode	00:00:00:00
Room Type	Small Room		

This sample shows Dolby E data with the external reference measurement.

Dolby Status		Program 1	
Program Desc Text	Tektronix Program 1		
Dolby Format	Dolby E 20	Dolby Surround Mode	Not Indicated
Channel Mode	3/2 L	Copyright Bit	No
Program Config	5.1	Original Bitstream	Yes
Metadata Source	AES Embedded 1-2	DC Filter	No
Dolby Data Rate	Not specified	Lowpass Filter	No
Bitstream Mode	Complete Main	LFE Lowpass Filter	No
Dolby E Frame Rate	25 fps	Surround 3 dB Atten	No
Dolby E Frame Loc	L42 F1 s1937	Surround Phase Shift	No
Ext Ref Guardband	L28 F1 s587		
DYNAMIC RANGE PARAMETERS		EXTENDED BSI	
Dialogue Level	-23 dB	Preferred Stereo Dmix	Lo/Ro
Program Loudness		Lt/Rt Center Mix Lvl	-3 dB
Average Loudness		Lt/Rt Surrnd Mix Lvl	-3 dB
Line Mode Cmpr	Film Standard	Lo/Ro Center Mix Lvl	-3 dB
RF Mode Cmpr	Film Standard	Lo/Ro Surrnd Mix Lvl	-3 dB
		Surround EX Mode	Not Indicated
RF Overmod Prot	Disabled	Headphone Mode	Not Indicated
Center Mix Lvl	-3 dB	A/D Converter Type	STD
Surround Mix Lvl	-3 dB		
Mixing Level	Not Indicated	SMPTE Timecode	15:00:00:00

This sample shows Dolby ED2 data with a Presentation option (in the upper right corner) selected.



Note: Presentation titles are user-selected. You can change them to refer to the related information as needed.

Dolby Status				
Presentation 5.1 Plus 3D				
Dolby E Pair 1(1-2)	Dolby E Pair 2(3-4)	Dolby ED2	Dolby Timing	
Evolution Pair 1(1-2)			Present	
Evolution Pair 2(3-4)			Present	
PRESENTATION NAME : 5.1 Plus 3D				
Objects	Presented	Presented	Presented	Presented
Type	Bed	Dynamic	Dynamic	Dynamic
Category	-	Generic	Generic	Generic
Index	-	1	2	3
Config	5.1	1.0	1.0	1.0
Position X	-	0	1	0.5
Position Y	-	0	0	1
Position Z	-	1	1	1

This sample shows Dolby Timing.

Dolby Status				
Program 1				
Dolby E Pair 1(1-2)	Dolby E Pair 2(3-4)	Dolby ED2	Dolby Timing	
Dolby E Frame Loc Pair 1(1-2)		L21 F1 s1937		
Dolby E Frame Loc Pair 2(3-4)		L21 F1 s1945		
Ext Ref Guardband Pair 1(1-2)		L328 F2 s772		
Ext Ref Guardband Pair 2(3-4)		L328 F2 s773		

Configure the Dolby Status Application

1. Select the **Tiles** icon ().
2. Select the tile with the Dolby Status application.
3. Select the **Tile** icon ().

Note: To move the settings left or right, select the **Move** icon () in the Settings menu header.

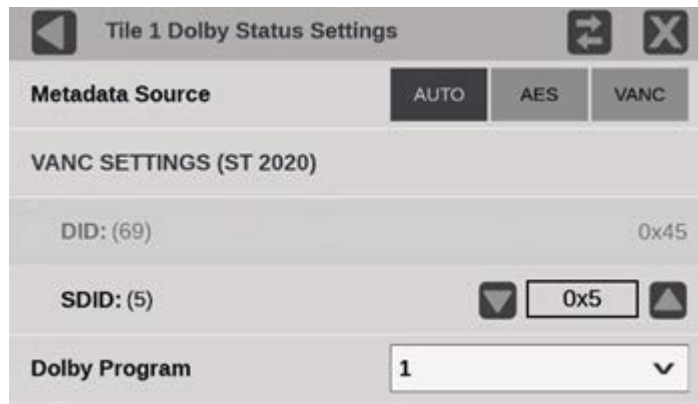

4. You can select the source of the Dolby E metadata from the incoming Dolby E audio if the instrument is decoding Dolby E audio or from VANC metadata if the Dolby E is decoded externally. In the **Metadata Source** section, select one of the following:
 - **Auto:** Selects the Dolby E audio by default as the metadata source, if it is available. If Dolby E audio is not available, it uses VANC audio.
 - **AES:** Selects the Dolby E audio as the metadata source. The Dolby Status application is blank if Dolby E is not being decoded.
 - **VANC:** Selects VANC as the metadata source. The SDID must be properly selected.
5. The **DID** section indicates the data identifier of the requested packet; it is set to 0x45 (69 decimal) and is not changeable.
6. In the **SDID** box, specify the Secondary Data Identifier of the requested packet. An SDID value of 01h is used when there is only one audio program associated with a video signal and there is no intended association between VANC packets with an SDID value of 01h and a specific audio channel pair.

Association Between the First Audio Channel Pair of an Audio Program and the SDID Values

Audio Channel Pair	SDID
No association	01h
Channel pair 1/2	02h
Channel pair 3/4	03h
Channel pair 5/6	04h
Channel pair 7/8	05h
Channel pair 9/10	06h

Association Between the First Audio Channel Pair of an Audio Program and the SDID Values

Audio Channel Pair	SDID
Channel pair 11/12	07h
Channel pair 13/14	08h
Channel pair 15/16	09h

When multiple audio programs are carried by, or associated with, a single video signal, the SDID value is used to identify the VANC data packets carrying the audio metadata for each of the audio programs.

The audio channels making up an audio program are assigned to consecutively numbered or consecutively arranged audio channel pairs. The VANC packets carrying the audio metadata for a specific audio program are identified by setting the SDID values of these packets to the value associated with the lowest numbered audio channel pair of the group of audio channel pairs carrying the complete audio program.

For example, if there is a six-channel program carried in the first three audio channel pairs and a stereo program carried by the fourth audio channel pair, then the VANC packets carrying the metadata for the six-channel program would have their SDID value set to 02h because the program starts in audio channel pair 1/2. The VANC packets carrying the metadata for the stereo program would have their SDID value set to 05h because the stereo program starts in audio channel pair 7/8.

- From the **Dolby Program** list, select the Dolby program number to monitor. The Program number on the top right of the Dolby Status application border is the same as the Dolby Program number in the Dolby Status Settings. Select the arrow and select the number of the program to monitor.

Dolby D/D Plus/E Status Elements

This section describes some elements that appear in the Dolby Status application for Dolby D, D Plus, or E. For a complete list of the elements that might appear, see the Dolby Metadata Guide at the [Dolby website](#).

- **Program Desc Text** is a 32-character ASCII text field that the program author uses to describe the audio program; for example, the name of the program (Movie Channel Promo), the program source (Football Main Feed), or the program language (Danish).
- **Dolby Format** indicates the Dolby Format. This indicator is also tied to the Dolby Format Error/Alarm: if the Alarm is asserted, the Dolby Format is displayed in red.
- **Channel Mode** (or Audio Coding Mode) indicates the active channels within the encoded bit stream, representing it in a ratio, X/Y, where X is the number of front channels (Left, Center, Right) and Y is the number of rear (Surround) channels. If the LFE Channel is present, an L is added at the end of the channel mode.

- **Program Config** determines how the audio channels are grouped in a Dolby E bitstream. Up to eight channels can be grouped together in individual programs, where each program contains its own metadata.
- **Metadata Source** indicates the input from which the Dolby Content is sourced.
- For Dolby E, **Dolby Data Rate** indicates the data rate that would be used to encode a Dolby Digital bitstream.
- **Bitstream Mode** describes the audio service in the Dolby Digital bitstream. A complete audio program can consist of a main audio service (a complete mix of all the program audio), an associated audio service comprising a complete mix, or a main service combined with an associated service. For more information about possible values, see the instrument online help; when the Dolby Status display is active in a tile, select the HELP button.
- **Dolby E Frame Rate** displays the frame rate of the Dolby E audio. If Dolby Frame Rate is not the same as the video Frame Rate, the rate value is displayed in red.
- **Dolby E Frame Loc** displays the location (line number and sample number) of the ST 337 preamble.
- **Dolby ExtRef Guardband** displays the location (line number and sample number) of the corresponding black-burst reference that aligns with the ST 337 preamble.\
- **Dialogue Level** represents the long-term, A-weighted average level of dialog within a presentation, $Leq(A)$.

Dolby ED2 Status Elements

This section describes some elements that appear in the Dolby Status application for Dolby ED2. For a complete list of the elements that might appear, see the Dolby Metadata Guide at the [Dolby website](#).

- The **Dolby E(Pair 1) 1-2** and **Dolby E(Pair 1) 3-4** tabs in the Dolby Status tile have most of the same elements as the Dolby D, D Plus, and E data. For more details, see [Dolby D/D Plus/E Status Elements](#).
- The **Dolby ED2** tab in the Dolby Status Tile has the following elements:
 - Evolution pair 1(1-2) and Evolution pair 2(3-4): Describes the status of the channel pairs (in parentheses) of the ED2 transport.
 - Type: This is the audio object type, such as Bed or Dynamic.
 - Index: This is the object number starting after the Audio Bed.
 - Position X, Position Y, Position Z: This positional metadata describes the audio objects in the bitstream.
- The **Dolby Timing** tab in the Dolby Status Tile has these elements:
 - Dolby E Frame Loc (pair 1) and Dolby E Frame Loc (pair 2): Displays the line, field, and sample numbers of the of the corresponding video of the Dolby ED2 preamble.
 - Ext Ref Guardband (pair 1) and Ext Ref Guardband (pair 2): Displays the line, field, and sample number of the corresponding black-burst reference that aligns with

the Dolby E preamble location. Make sure the Dolby E preamble location stays in field 1 of the reference signal. If it stays in field2 of the reference, the Dolby E stream might corrupt at signal switching.

Before checking this measurement, make sure that Analog or PTP is selected (in Setting and then the Reference menu) and the incoming signal is locked to a reference signal on the status bar.

AES Channel Status Application

Note: In multi-input mode, AES Channel Status works only with the primary channel.

The AES Channel Status application provides detailed data for each audio channel in the monitored signal, up to 16 channels total. It is available only for SDI.

The data is presented by channel in transport order, regardless of how the Audio application maps or configures the channels.

AES Channel Status							
Field Name	CHL(1)	CHR(2)	CHL(3)	CHR(4)	CHL(5)	CHR(6)	CHL(7)
Channel Use	Professional	Professional	Professional	Professional	Professional	Professional	Professional
Linear PCM Ident	PCM	PCM	PCM	PCM	PCM	PCM	PCM
Emphasis	No Emphasis	No Emphasis	No Emphasis	No Emphasis	No Emphasis	No Emphasis	No Emphasis
Locking of Source	Locked	Locked	Locked	Locked	Locked	Locked	Locked
Sample Frequency	48 KHz	48 KHz	48 KHz	48 KHz	48 KHz	48 KHz	48 KHz
Channel Mode	2 Channel	2 Channel	2 Channel	2 Channel	2 Channel	2 Channel	2 Channel
User Bits Mode	192 bit block	192 bit block	192 bit block	192 bit block	192 bit block	192 bit block	192 bit block
AUX Bits Use	Main Audio	Main Audio	Main Audio	Main Audio	Main Audio	Main Audio	Main Audio
Audio Word Length	24/24	24/24	24/24	24/24	24/24	24/24	24/24
Alignment Level	Not Indicated	Not Indicated	Not Indicated	Not Indicated	Not Indicated	Not Indicated	Not Indicated
Reference Signal	Not a ref	Not a ref	Not a ref	Not a ref	Not a ref	Not a ref	Not a ref
Origin	A1-1	A1-2	A1-3	A1-4	A2-1	A2-2	A2-3
Destination							
Sample Number	0	0	0	0	0	0	0
Time of Day	00:00:00:00000	00:00:00:00000	00:00:00:00000	00:00:00:00000	00:00:00:00000	00:00:00:00000	00:00:00:00000

Note: Only Professional mode (in Channel Use) is available.

Note: If the two Block CRC lines (should be and computed) do not match, the Block CRC (computed) line turns red as a warning that the numbers are mismatched and a CRC error has happened.

Time of Day	00:00:00:00000	00:00:00:00000	00:00:00:00000	00:00:00:00000	00:00:00:00000
Block CRC (should be)	01001100	01100110	10101111	00110010	10011001
Block CRC (computed)	01001100 Ok	01100110 Ok	10101111 Ok	00110010 Ok	10011001 Ok

Event Log Application

The Event Log application provides a view of detected errors. The display buffer for the application shows 1,000 log entries.

Note: To see the available columns (Notes and Date), set the application to full-screen.

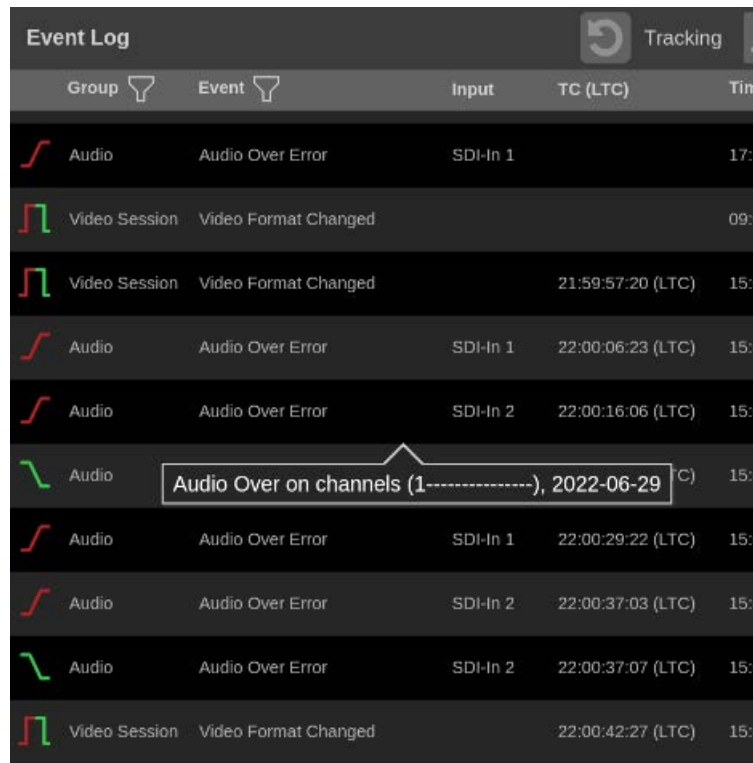

Event Log Elements

- **Reset icon:** Select the **Reset** icon (🔄) to hide all log items, so only new log items are displayed. Select **Undo Reset** in the Settings menu to show the log items that were hidden by pressing Reset.
- **Track icon:** The **Track** icon (📌) and the text “Tracking” to the left mean the Event Log is tracking new events. The newest events appear at the bottom of the Event Log.

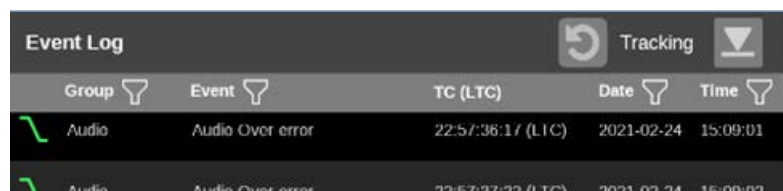

Scroll in the Event Log list or select the control and hold it, then drag it to a previous event. Tracking new events is paused automatically.

- **Pause icon:** The **Pause** icon (⏸) and the text “Paused” means the Event Log is not tracking new events. Select the **Pause** icon to return to tracking new events.



The Error Log has the following columns:

- **Group:** Lists the group the event is related to and shows the current state of the log entries:
 - Red-rising edge (↗) items are detected errors.
 - Green-falling edge (↘) items are errors that have cleared.
 - Red and green-rising and falling edge (↕) items indicate a momentary error that was in error condition but is now in normal condition. The PTP or TC field is blank when the selected time source is not available.
 - White items are informational and identify a change in instrument state.
- **Event:** Lists the title of the error.
- **PTP (UTC) or TC (LTC):** Shows the time, in the mode chosen by the user, the error occurred.
- **Date:** Shows the date, according to the internal clock, that the error occurred in the form YYYY-MM-DD.
- **Time:** Shows the time, according to the internal clock, that the error occurred in the form HH:MM:SS.

Configure the Event Log Application

1. Select the **Tiles** icon (⌘).
2. Select the tile with the Event Log application.
3. Select the **Tile** icon (⚙).

Note: To move the settings left or right, select the **Move** icon (↔) in the Settings menu header.

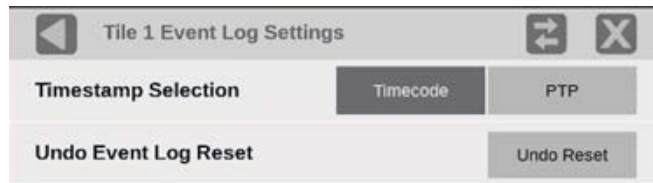

4. In the **Timestamp Selection** section, select one of the following:
- **Timecode:** To set TC (LTC) or TC (VITC) for error tracking in the Event Log.
To configure TC (LTC) or TC (VITC):
 - i. Select the **Settings** icon (⚙️), then select **Anc Data**.
 - ii. In **Timecode Format** select **LTC** or **VITC**.

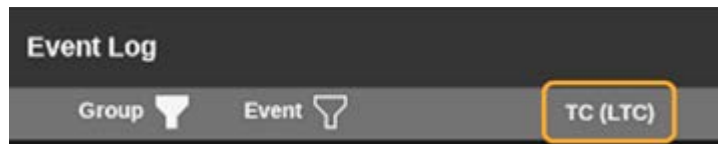

- **PTP:** To set PTP (UTC) for error tracking in the Event Log.

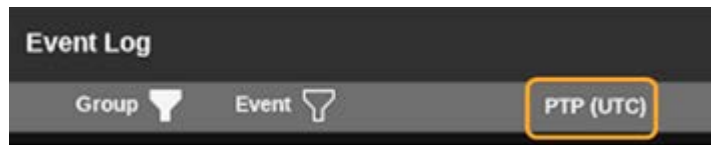

To cancel the last reset of the logged events, select **Undo Reset**.

Filter Event Log Events

This section explains the several ways to sort logged events.

Filter by Group

- To open the group filter, select the **Group** heading.

Note: If there is any other filter applied (Event, Date, Time—marked by a full filter icon (☒) next to a heading), it limits what any other filter shows. For example, if no events are selected in the Event filter, then no errors appear even if all the groups are selected.



- To move the menu to a location, select-and-hold anywhere in the menu and drag it.
- To select all checkboxes (see all errors), or clear all (hide all errors), select the **All Groups** checkbox. The Event Log immediately adds or removes errors from the list.
 - If all groups are selected (no filter), the Group filter icon is empty.

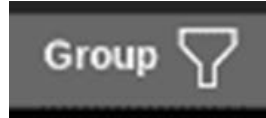

- If any group is not selected (a filter is applied), the Group filter icon is full.

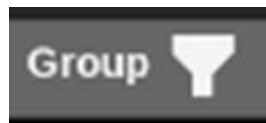

- To select or remove the check from any single checkbox, select anywhere in the title line.

Filter by Event

- To open the event filter, select the **Event** heading.

Note: If there is any other filter applied (Group, Date, Time—marked by a filled filter icon——next to a tile), it limits what any other filter shows. For example, if no groups are selected in the Group filter, then no errors appear even if all the events are selected.

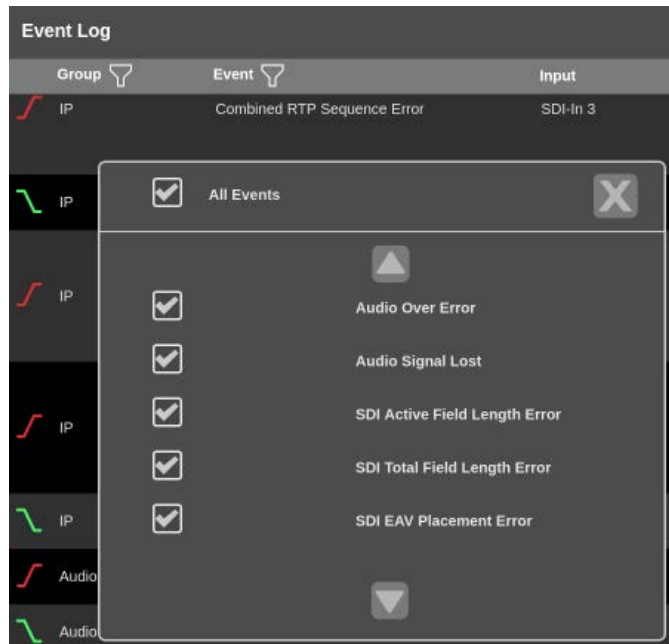

- To move the menu to a location, select-and-hold anywhere in the menu and drag it.
- To select all checkboxes (see all errors), or remove all checks (hide all errors), select the **All Events** checkbox. The Event Log immediately adds or removes errors from the list.
 - If all groups are selected (no filter), the filter icon is empty.



- If any group is not selected (a filter is applied), the filter icon is full.



- To select or remove the check from any single checkbox, select anywhere in the line of the title.
- To scroll through the list of events, select the arrows at the top and bottom of the menu.

Filter by Date or Time

- To open the Date and Time filter, select either the **Date** or **Time** heading. Both open the same menu.

Note: If there is any other filter applied (Group, Event—marked by a filled filter icon——next to a tile), it limits what any other filter shows. For example, if no groups are selected in the Group filter, then no errors appear even if all the events are selected.

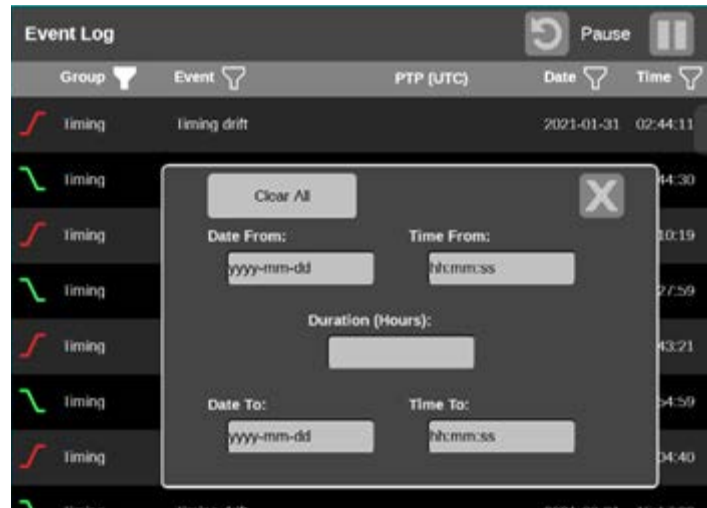

- To move the menu to a location, select-and-hold anywhere in the menu and drag it.
- To enter a filter date:
 - In the **Date From** box, type a date (yyyy-mm-dd) or select the date using the on-screen Adjust Date tool.
 - If needed, select a date in the **Date To** box.

Note: Other filters (duration, time) are not required.



- To enter a filter time:
 - Select in the **Time From** box and either type a time (hh:mm:ss) or select the time using the on-screen Adjust Time tool, and select **Enter**.
 - If needed, select a time in the **Time To** box.

Note: Other filters (duration, date) are not required.

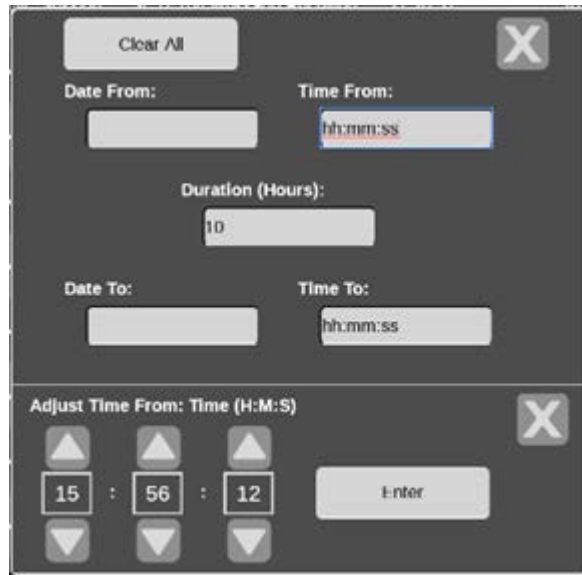

- To enter a duration filter, in the **Duration** box, type the number of hours or use the on-screen keypad, and select **Enter**.

Note: Other filters (date, time) are not required.



- If no date, duration, or time filter is entered (no filter), the filter icon is open.



- If a date, duration, or time filter is entered (a filter is applied), the filter icon is filled.



IP Status Application

The IP Status application provides an overview of the monitored IP stream and shows the status of each program in the stream. After the input signals have been subscribed to using the Input Settings menu, the traffic on the SFP ports can be viewed using the IP Status application.

Use this application if there are possible IP signal integrity issues. If a flow has a red X, PRISM has detected issues. The next application to use is the IP Session. Depending on the network switch deployed, the traffic might not appear in the IP Status application immediately.

IP Status Run Time: 0d, 14:15:45

✔ Port 1: OK
 Total: 3.118 Gb/s 9

✔ Port 2: OK
 Total: 5.834 kb/s

ID	PORT	PROTOCOL	BITRATE	PAYLD	DEST IP	SOURCE
✔ 9	1	S2022.6	3.118 Gb/s	98	229.1.1.2:50000	192
● 10	1	S2110.20	0b/s	96	229.20.1.12:50011	192
● 11	1	S2110.30	0b/s	97	229.30.1.12:50012	192
● 12	1	S2110.30	0b/s	97	229.30.1.12:50011	192
● 13	1	S2110.40	0b/s	100	229.40.1.12:50011	192

Configure the IP Status Application

1. Select the **Tiles** icon ().
2. Select the tile with the IP Status application.
3. Select the **Tile** icon ().

Note: To move the settings left or right, select the **Move** icon (↔) in the Settings menu header. Select this icon.

4. To monitor both Port 1 and Port 2, select **Both**.



If you select both ports, two traffic bars show the amount of traffic on each port, and there is a traffic table with a Port column.

- The active monitored streams are always displayed at the top of the list.
- The columns are sortable.
- The selected input is now highlighted in the ID column.
- When the row has a yellow gradient, it indicates a signal that was present and is now gone. Select the reset button at the right side of the banner (at the top) to clear the signals that are no longer there.

ID	PORT	PROTOCOL	BITRATE	PAYLD	DEST IP	SO
✓ 9	1	S2022.6	3.118 Gb/s	98	229.1.1.2:50000	192
○ 10	1	S2110.20	0b/s	96	229.20.1.12:50011	192
○ 11	1	S2110.30	0b/s	97	229.30.1.12:50012	192
○ 12	1	S2110.30	0b/s	97	229.30.1.12:50011	192
○ 13	1	S2110.40	0b/s	100	229.40.1.12:50011	192

Status Indicators

The indicators in the left column of an IP Status tile describe the signal parameter:

- ✓ The signal parameter has not been in an error condition.
- ! The signal parameter was in an error condition, but the error has cleared.
- ✗ The signal parameter is in an error condition.
- The signal parameter is not being monitored for an error condition.

The following backgrounds indicate the flow status:

A green background means the flow is present and selected.



A black background means the flow is present but not selected.



A yellow background means the flow was present but is not now.



IP Status Elements

- **Port 1** and **Port 2**: Status of Port 1 and Port 2.
- **Total**: Shows the total bit rate of the video in the IP stream.
- **IP stream bandwidth bar**: The blue bar outline at the top of the display represents the total bandwidth of the 10-GE or 25-GE stream, depending on the type of SFP that is present. The blue bars inside the outline show the relative bandwidth size of items in the IP stream compared to the total available bandwidth of the stream. Numbers inside the blue bars correspond to the ID numbers listed in the display.
- **Run Time**: The instrument maintains a running IP Status Session. The Run Time readout displays the amount of time that has elapsed during the current IP Status Session. The time is displayed as “DD, HH:MM:SS”, where DD is number of days, HH is number of hours, MM is number of minutes, and SS is number of seconds.
- **Reset icon**: Select the **Reset** icon (🔄) to reset the status session. After a reset, items appear in the list in the order they are detected.

The IP Status application is divided into these columns:

- **ID**: Shows the ID number of each item in the IP stream. The ID numbers correspond to the numbers in the blue bar at the top of the display.
- **PORT**: Shows the Port number being monitored.
- **PROTOCOL**: Shows the protocol being used by each item in the IP stream.
- **BITRATE**: Shows the bit rate of each item in the IP stream.
- **PAYLD**: Shows the RTP Payload Type number of each IP stream.
- **DEST IP**: Shows the destination IP address and port number of the monitored stream in the format <destination IP address>:<port number>.
- **SOURCE IP**: Shows the source IP address and port number of the monitored stream in the form <source IP address>:<port number>.
- **DEST MAC**: Shows the destination MAC address of the monitored stream.
- **SOURCE MAC**: Shows the source MAC address of the monitored stream.
- **PTP DOM**: Shows the PTP domain of the monitored stream.
- **SEQ ERR**: Shows the number of sequencing errors in the monitored stream.
 - IN-Error count means “IN”-coming stream errors.

- CORR-Error count means after “CORR”-rection process of packet reordering or ST 2022-7. Zero means no errors occurred since reset. Steady count mean errors are not occurring. Increasing count means new errors are occurring.

- **RTP CLK:** Shows the RTP clock of the monitored stream.
- **RTP MARK:** Shows the RTP marker frequency of the monitored stream.



IP Session Application

The IP Session application uses several tabs to display the status of various IP stream parameters. Select any tab title to view the associated information: Layer 1/2, Video, Audio, Data, PTP, or NMOS.

Note: Option MP2-IP-MEAS must be installed to use the IP Session application. The display shows only Path 1 unless you enable ST2022-7 Seamless Switching (see [Configure ST 2022-6](#)). There is a difference between “Port” and “Path.” The Port is the physical SFP port that is used to input the IP signal. Path 1 and Path 2 are the signal paths to be used for seamless switching. This differentiation is being made because it is possible for both Path 1 and Path 2 to use a single Port.

IP Session		Run Time: 0d, 15:11:29		Running <input type="checkbox"/>	
LAYER 1/2	VIDEO	AUDIO-1	DATA	PTP	NMOS
LAYER 1		PORT 1		PORT 2	
✓	25GbE Link	OK		OK	
	SFP Loss Of Signal (LOS)	OK		OK	
LAYER 2		PATH 1		PATH 2	
		STATUS	ERR SECS	STATUS	ERR SECS
✓	Lock	OK	6	OK	6
✓	CRC Error	OK	0	OK	0
LAYER 2 METRICS		PATH 1		PATH 2	
	Rx Bytes	7,616,937,904,320		7,418,943,349,696	
	Rx BER High	0		0	
	Rx CRC Errors	0		0	
	Rx Frames Ok	5,809,973,672		5,674,135,783	
	Rx Frames Errored	0		0	
	Rx Undersize Packets	0		0	
	Rx Oversize Packets	0		0	
	Tx Bytes	8,950,951,217,367		1,143,995	
	Tx Frames Ok	6,745,804,060		12,989	
	Tx Frames Errored	0		0	

Configure the IP Session Application

1. Select the **Tiles** icon (.
2. Select the tile with the IP Session application.
3. Select the **Tile** icon (.

Note: To move the settings left or right, select the **Move** icon () in the Settings menu header.

4. In the **Audio** list, select the audio stream for the selected input to monitor. The selected audio stream is noted in the Audio tab.

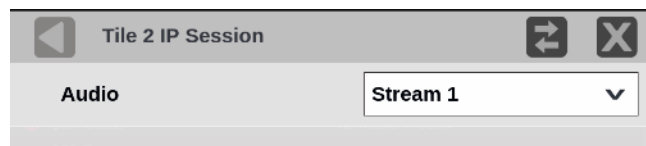

IP Session Header Elements

The elements at the top of the IP Session application are shared between several tabs. Select a tab to view the associated display. Each tab has a status indicator to provide a quick view of the status of the parameters in each tab.

- **Display tabs:** Select a tab to view the associated display. Each tab has a status indicator to provide a quick view of the status of the parameters contained in each tab.
- **Layer 1/2:** Select to view the status of various signal parameters in the physical and link layers.
- **Video:** Select to view the status of the video in the stream.
- The **AUDIO** tab label indicates which stream is being monitored. For example, AUDIO-1 indicates stream 1 as configured in the Settings – Input menu. In the application menu, select the Audio stream to monitor.
- The Data tab label indicates which stream is being monitored. For example, Data-1 indicates stream 1 as configured in the Settings – Input menu. In the application menu, select the Data stream to monitor.
- **PTP:** Select to view PTP parameters.
- **NMOS:** Select to view information on the registration server and the last Session Description Protocol (SDP) files received.
- **Run Time:** The instrument maintains a running monitoring session for the IP Session application. The Run Time readout displays the amount of time that has elapsed during the current monitoring session. The time is displayed as “DD, HH:MM:SS,” where DD is number of days, HH is number of hours, MM is number of minutes, and SS is number of seconds.
- **Reset icon:** Select the **Reset** icon () to reset the monitoring session.

- **Run / Stop icons:** When the monitoring session is running (collecting error data), select the **Stop** icon (□) to stop the session. When the session is stopped (no error data collection and no display updates), select the **Play** icon (▶) to start the session.

LAYER 1/2 Tab

Note: In multi-input mode, layer1/2 works with both primary and secondary channels.

To view the status of these signal parameters, select the **LAYER 1/2** tab.

IP Session		Run Time: 0d, 02:01:23		Running <input type="checkbox"/>	
LAYER 1/2	VIDEO	AUDIO	DATA	PTP	NMOS
LAYER 1		PORT 1		PORT 2	
10GbE Link		OK		OK	
SFP Loss Of Signal (LOS)		OK		OK	
LAYER 2		PATH 1		PATH 2	
		STATUS	ERR SECS	STATUS	ERR SECS
✔	Lock	OK	0	OK	0
✔	CRC Error	OK	0	OK	0
LAYER 2 METRICS		PATH 1		PATH 2	
Rx Bytes		1,011,850,536,954		1,015,520,405,677	

- **Layer 1:**
 - **10GbE Link or 25GbE Link:** Shows the status of the link connection.
 - ◆ **Disconnected:** No SFP module present.
 - ◆ **No Signal:** No input signal detected.
 - ◆ **OK:** Locked to input signal.
 - **SFP Loss of Signal (LOS):**
 - ◆ **Disconnected:** No SFP module present.
 - ◆ **OK:** Locked to input signal.

Note: The functionality of this signal depends on the brand of SFP installed. The signal is intended as a preliminary indication that the received signal strength is below a range specified by the SFP vendor. Such an indication typically points to non-installed cables, broken cables, or a disabled, failing or powered-off transmitter at the far end of the cable.

- **Layer 2:**

- **Lock:** Shows the lock status of the link:
 - ◆ **OK:** The 10/25G Ethernet Phy Rx port is successfully locked to the inbound Ethernet signal.
 - ◆ **ERROR:** The 10/25G Ethernet Phy Rx port lost lock to the incoming Ethernet signal during the last second. This indicates there is likely a physical layer problem with the link.
- **CRC Error columns:**
 - ◆ **STATUS:** There have been no overflow errors in the Ethernet MAC during the last second.
 - ◆ **ERR SECS:** This is an interval of a second during which any error has occurred, regardless of whether that error was a single-bit error, or a complete loss of communication for that entire second.

- **Layer 2 Metrics:**

- **Rx Bytes:** A count of the number of bytes received
- **Rx BER High:** The Sync Header BER is greater than 10⁻⁴
- **Rx CRC Errors:** A count of the number of CRC errors detected
- **Rx Frames Ok:** A count of the number of Ethernet frames received without error
- **Rx Frames Errored:** A count of the number of Ethernet frames received with errors detected
- **Rx Undersize Packets:** A count of the number of Ethernet frames received that are less than 64 bytes long
- **Rx Oversize Packets:** A count of the number of Ethernet frames received that are greater than 1522 bytes long
- **Tx Bytes:** A count of the number of bytes transmitted
- **Tx Frames Ok:** A count of the number of Ethernet frames transmitted without error
- **Tx Frames Errored:** A count of the number of Ethernet frames transmitted with errors detected

VIDEO Tab

To view the status of the video in the stream, select the **VIDEO** tab.

		PORT 1	PORT 2
L3 IP			
Source Addr		192.168.100.200	192.168.100.200
Destination Addr		239.20.10.6	239.20.10.6
L4 UDP			
Source Port		50000	50000
Destination Port		50020	50020
L5 RTP			
Version		2	2
Padding		false	false
Extension		false	false
CSRC		0	0
Marker		0	0

- **L3 IP:**
 - **Source Addr:** Lists the source addresses for the L3 IP layer.
 - **Destination Addr:** Lists the destination addresses for the L3 IP layer.
- **L4 UDP:**
 - **Source Port:** Lists the source ports for the L4 UDP layer.
 - **Destination Port:** Lists the destination ports for the L4 UDP layer.
- **L5 RTP:** Lists these parameters of the L5 RTP (Real Time Protocol) layer. RTP Datagrams are defined in IETF RFC 3550.
 - **Version:** Identifies the version of RTP and should be a value of 2.
 - **Padding:** Indicates whether padding bytes are present. Possible values are:
 - ◆ **false:** Indicates no extra padding bytes are at the end of the RTP packet.
 - ◆ **true:** Indicates that padding octets have been added to the RTP packet that are not part of the payload.
 - **Extension:** Indicates whether an extension is present. Possible values are:
 - ◆ **false:** Indicates no extension is present.
 - ◆ **true:** Indicates an extension is present.
 - **CSRC:** Identifies the Contributing Source IDs. This value should be set to zero.
 - **Marker:** This value should be set to 1 to indicate the last MediaDatagram of the video frame. The value is set to 0 for all other Media Datagrams and should be 0 for most packets.

Note: For 2022-6 signals, the status indicator turns red if the Marker Bit Frequency does not match the frame rate indicated in the HBRMT header. For 2110 signals, the status indicator turns red if the Marker Bit Frequency does not match the measured field rate of the detected format.

- **Payload type:** Identifies the type of RTP payload:
 - ◆ **98:** Indicates an ST 2022.6 High Bit Rate Media Transport.
 - ◆ **99:** Indicates an ST 2022.5 High Bit Rate Media Forward Error Correction (FEC) payload.
 - ◆ **33:** Indicates an ST 2022.2 Constant Bit Rate MPEG-2 Transport Stream Adaptive Sample Picture Encapsulation (ASPEN) payload.
-

Note: The payload type for ST 2110 streams should be between 96 and 127. The payload type is set by the user.

- **Sequence number:** RTP sequence counter that changes by one for each RTP Media Datagram sent.
-

Note: The status indicator turns red if the received RTP sequence numbers do not change by 1 on every packet.

- **Time Stamp:** Reflects the sampling instant of the first octet in the RTP datagram. This value can be used to determine packet sequence errors and jitter calculations to be made.
-

Note: For 2022-6 signals, the status indicator turns red if the Time Stamp field does not change at the rate of 27 MHz on every packet. For 2110 signals, the status indicator turns red if the Time Stamp field does not change at the start of every field or frame at the rate of 90 kHz on every packet.

- **SSRC:** Identifies the Synchronization Source ID and is set in compliance with RFC3550. This identifier is chosen randomly and should be unique so no two SSRC have the same value with an RTP session.
 - **Interface Sampling Frequency Error:** This error indicates that the incoming video is arriving at a frequency outside of the supported range to maintain stable video lock. The signal on the SDI Out video connector may be affected. Possible interface sampling frequency declaration in stream header is incorrect for the stream type being carried.
-

Note: The status indicator turns red if the received frame rate is not stable enough during conversion to SDI. Marker Bit Frequency Errors can also trigger this indicator.

- **HBRMT:** Lists these parameters of the High Bit Rate Media Payload Header:

Note: The HBRMT parameters apply only to ST2022-6 streams.

- **Video Source Format:** Identifies whether source formatting is present:
 - ◆ **Not Present:** Indicates no Source Format information is present.
 - ◆ **Present:** Indicates source formatting is present.
- **Video Source ID:** Identifies the video source:
 - ◆ **Primary (0x0):** Indicates a primary stream.
 - ◆ **Protect (0x1):** Indicates a protected stream.
 - ◆ **Reserved (n):** When *n* is a number other than 0 or 1, indicates that a reserved value is being used.
 - ◆ **Frame Count:** The Video Frame counter changes in value for the next RTP sequence and rolls over after 255.

Note: The status indicator turns red if the frame count field does not change by 1 at the start of every frame.

- **Reference for time stamp:** Identifies the time stamp reference:
 - ◆ **Unlocked (0x0):** Indicates the time stamp is not locked to any particular source.
 - ◆ **Reserved (0x1):** Indicates an illegal value.
 - ◆ **UTC (0x2):** Indicates the time stamp is locked to a UTC time source.
 - ◆ **Private (0x3):** Indicates the time stamp is locked to a private time source.
- **Video Payload Scrambling:** Identifies the payload scrambling status:
 - ◆ **Unscrambled (0x0):** Indicates the payload is not scrambled.
 - ◆ **Reserved (n):** When *n* is a number other than 0, it indicates a reserved value is being used.
- **FEC usage:** Identifies the FEC usage status:
 - ◆ **No FEC (0x0):** Indicates no forward-error correction is being used.
 - ◆ **Column (0x1):** Indicates column FEC is being used.
 - ◆ **Col/Row (0x2):** Indicates column and row FEC are being used.
 - ◆ **Reserved (n):** When *n* is a number greater than 2, indicates a reserved value is being used.

- **Clock Frequency:** Identifies the video word clock frequency of the payload video. Possible values are:
 - ◆ **0000:** No time stamp
 - ◆ **0001:** 27 MHz
 - ◆ **0010:** 148.5 MHz
 - ◆ **0011:** 148.5 /1.001 MHz
 - ◆ **0100:** 297 MHz
 - ◆ **0101:** 297/1.001 MHz
 - ◆ **0110-1111:** Reserved
- **Reserved:** This value should be set to 0.
- **Video Source Format fields:** These Video Source Format field values are displayed:
 - ◆ **MAP:** Identifies which SMPTE mapping scheme is used. Possible values are: Direct (0x0), LevelB (0x1), 2xHD (0x2), or Reserved (n).
 - ◆ **FRAME:** Identifies the raster size. Possible values are: Unspecified (0x0), 720x480i (0x10), 720x576i (0x11), 1920x1080i (0x20), 1920x1080p (0x21), 1920x1080sf (0x22), 2048x1080p (0x23), 2048x1080sf (0x24), or 1280x720p (0x30).
 - ◆ **F rate:** Identifies the frame rate. Possible values are: Unknown/Unspecified frame rate 2.970 GHz signal (0x00), Unknown/Unspecified frame rate 2.970/1.001 GHz signal (0x01), Unknown/Unspecified frame rate 1.485 GHz signal (0x02), Unknown/Unspecified frame rate 1.485/1.001 GHz signal (0x03), Unknown/Unspecified frame rate 0.270 GHz signal (0x04), Reserved (0x04-0x0f), 60 (0x10), 60/1.001 (0x11), 50 (0x12), Reserved (0x13), 48 (0x14), 48/1.001 (0x15), 30 (0x16), 30/1.001 (0x17), 25 (0x18), Reserved (0x19), 24 (0x1A), 24/1.001 (0x1B), Reserved (0x1C-0xFF).
 - ◆ **Sample:** Identifies the pixel sampling/quantization scheme. Possible values are: Unspecified (0x0), 4:2:2/10 bit (0x1), 4:4:4/10 bit (0x2), 4:4:4/10 bit (0x3), 4:2:2/12 bit (0x5), 4:4:4/12 bit (0x6), 4:4:4/12 bit (0x7), or 4:2:2/4/12 bit (0x8).
 - ◆ **Fmt-Reserve:** This bit is reserved for future use and is set to 0.
- **Video TimeStamp:** Shows the value of a free-running counter that is synchronous with the interface word clock of the encapsulated video. This timestamp is fixed at the transmitter to the first information contained in the datagram.
- **Header Extension:** Indicates the number of four-octet header extension words that come after the HBRMT payload.

Audio Tab

The AUDIO tab label indicates which stream is being monitored. For example, AUDIO-1 indicates stream 1 as configured in the Settings – Input menu. Select the Audio stream to monitor in the application menu.

IP Session		Run Time: 0d, 15:19:45		Running	
LAYER 1/2	VIDEO	AUDIO-1	DATA	PTP	NMOS
		PORT 1	PORT 2		
L3 IP					
Source Addr		173.100.1.2	173.100.1.2		
Destination Addr		229.30.21.2	229.30.21.2		
L4 UDP					
Source Port		50000	50000		
Destination Port		50030	50030		
L5 RTP					
Version		2	2		

Configure the Audio Stream

1. Select the **Tile** icon (⚙️) in the application bar.
2. Select the **Audio** tab and select the stream number to monitor. The selected audio stream is noted in the AUDIO tab.

IP Session		Run Time: 0d, 15:40:24		Running	
LAYER 1/2	VIDEO	AUDIO-4	DATA	PTP	NMOS
		PORT 1	PORT 2		
L3 IP					
Source Addr		173.100.1.2			
Destination Addr		229.30.24.2			
L4 UDP					
Source Port					
Destination Port					
L5 RTP					
Version					

AUDIO Tab Elements

- **L3 IP:**
 - **Source Addr:** Lists the source addresses for the L3 IP layer.
 - **Destination Addr:** Lists the destination addresses for the L3 IP layer.
- **L4 UDP:**
 - **Source Port:** Lists the source ports for the L4 UDP layer.
 - **Destination Port:** Lists the destination ports for the L4 UDP layer.
- **L5 RTP:** Lists these parameters of the L5 RTP (Real Time Protocol) layer. RTP Datagrams are defined in IETF RFC 3550.
 - **Version:** Identifies the version of RTP and should be a value of 2.
 - **Padding:** Indicates whether padding bytes are present. Possible values are:
 - ◆ **false:** Indicates no extra padding bytes are at the end of the RTP packet.
 - ◆ **true:** Indicates that padding octets have been added to the RTP packet that are not part of the payload.

- **Extension:** Indicates whether an extension is present. Possible values are:
 - ◆ **false:** Indicates no extension is present.
 - ◆ **true:** Indicates an extension is present.
- **CSRC:** Identifies the contributing source IDs. This value should be set to 0.
- **Marker:** This value should be set to 1 to indicate the last media datagram of the video frame. The value is set to 0 for all other media datagrams and should be 0 for most packets.
- **Payload type:** Identifies the type of RTP payload.
- **Sequence number:** RTP sequence counter changes by one for each RTP media datagram sent.

Note: The status indicator turns red if the received RTP sequence numbers do not change by 1 on every packet.

- **Time Stamp:** Reflects the sampling instant of the first octet in the RTP datagram. This value can be used to determine packet sequence errors and jitter calculations to be made.

Note: The status indicator turns red if the Time Stamp field does not change at 48-kHz rate on every group of audio samples.

- **SSRC:** Identifies the synchronization source ID and is set in compliance with RFC3550. This identifier is chosen randomly and should be unique so no two SSRC have the same value with an RTP session.

Data Tab

The DATA tab indicates which stream is being monitored. For example, DATA-1 indicates stream 1 as configured in the Settings – Input menu. Select the Data stream to monitor in the application menu.

IP Session		Run Time: 0d, 02:25:13	Running
LAYER 1/2	VIDEO	AUDIO	DATA
✓	✓	✓	✓
		PORT 1	PORT 2
L3 IP			
Source Addr		192.168.1.26	192.168.1.27
Destination Addr		229.40.1.12	229.40.2.12
L4 UDP			
Source Port		50011	50011
Destination Port		50011	50011
L5 RTP			
Version		2	2

- **L3 IP:**
 - **Source Addr:** Lists the source addresses for the L3 IP layer.
 - **Destination Addr:** Lists the destination addresses for the L3 IP layer.
- **L4 UDP:**
 - **Source Port:** Lists the source ports for the L4 UDP layer.
 - **Destination Port:** Lists the destination ports for the L4 UDP layer.
- **L5 RTP:** Lists the parameters of the L5 RTP (Real Time Protocol) layer. RTP datagrams are defined in IETF RFC 3550.
 - **Version:** Identifies the version of RTP and should be a value of 2.
 - **Padding:** Indicates whether padding bytes are present. Possible values are:
 - ◆ **false:** Indicates no extra padding bytes are at the end of the RTP packet.
 - ◆ **true:** Indicates that padding octets have been added to the RTP packet that are not part of the payload.
 - **Extension:** Indicates whether an extension is present. Possible values are:
 - ◆ **false:** Indicates no extension is present.
 - ◆ **true:** Indicates an extension is present.
 - **CSRC:** Identifies the Contributing Source IDs. This value should be set to zero.
 - **Marker:** This value should be set to 1 to indicate the last media datagram of the video frame. The value is set to 0 for all other media datagrams and should be 0 for most packets.

Note: For 2022-6 signals, the status indicator turns red if the Marker Bit Frequency does not match the frame rate indicated in the HBRMT header. For 2110 signals, the status indicator turns red if the Marker Bit Frequency does not match the measured field rate of the detected format.

- **Payload type:** Identifies the type of RTP payload.
- **Sequence Number:** RTP sequence counter changes in increments of one for each RTP media datagram sent.
- **Time Stamp:** Reflects the sampling instant of the first octet in the RTP datagram. This value can be used to determine packet sequence errors and jitter calculations to be made.

Note: For 2022-6 signals, the status indicator turns red if the Time Stamp field does not change at the rate of 27 MHz on every packet. For 2110 signals, the status indicator turns red if the Time Stamp field does not change at the start of every field or frame at the rate of 90 kHz on every packet.

- **SSRC:** Identifies the synchronization source ID and is set in compliance with RFC3550. This identifier is chosen randomly and should be unique so no two SSRC have the same value with an RTP session.

PTP Tab

Note: PTP is supported in multi-input mode.

Select the **PTP** tab to view the status of the PTP elements in the stream. PTP is currently supported only on 10/25 GE SFP Port 1. For instructions on locking to PTP see [Configure Reference Settings](#).



IP Session		Run Time: 0d, 00:48:34	Running		
LAYER 1/2	VIDEO	AUDIO	DATA	PTP	NMOS
✓	✗	✓	✓	✓	
✓	Lock Status	Locked			
	PTP Time	2018-06-12 22:28:54 (UTC)			
	Master/Slave Phase Lag	+ 83 ns			
	Grandmaster ID	08:00:11:ff:fe:21:90:2b			
	Steps Removed	2			
	Domain	110			
	Profile	General			
	Delay Message Interval	Follow Master			
	Grandmaster BMCA Values				

- **Lock Status:** Indicates whether the instrument PTP follower is locked to the leader PTP signal for the selected domain. These values may appear:
 - **No leader present:** Indicates that the leader PTP clock has not been detected on the selected domain.
 - **Locked:** Indicates that the leader PTP clock is detected and there is less than 1000 ns of phase lag between the leader clock and the instrument.
 - **Unlocked:** Indicates that the leader PTP clock is detected and there is greater than 1000 ns of phase lag between the leader clock and the instrument.
- **PTP time:** Shows the time derived from the PTP Leader as UTC (Coordinated Universal Time).
- **Leader/Follower Phase Lag:** Shows the detected offset between the leader and follower clocks.
- **Offset from Leader:** The Offset from Leader is the phase error of the phase-locked loop, which controls the follower clock. The phase lag is a reasonable estimate of how well the PTP follower is locked to the leader; however, the phase lag does not indicate whether there is any asymmetry in the network.
- **Grandmaster ID:** Shows the MAC Address of PTP Leader with the bytes ff:fe inserted in the middle. This ID is also used in the BMCA as a tiebreaker if all of the parameters match down through priority 2.
- **Steps Removed:** Shows the number of communication paths traversed between the local clock and the Grandmaster clock.

- **Domain:** Shows the domain being used. Domains allow multiple PTP services to coexist simultaneously on one physical Ethernet connection.
- **Profile:** Shows the profile being used: General, AES67, or ST2059. This is the user-selected profile set on the Settings, Reference configuration menu page and is not detected on the input.
- **Delay Message Interval:** For Multicast communication mode, the only delay message interval allowed is "Follow Leader." In this mode, the follower sets the delay request rate according to the information sent by the leader in the delay response message.

Note: The PRISM monitor currently supports Multicast communication mode and SMPTE mixed mode without negotiation.

- **Grandmaster BCMA Values:** Lists these values for the Grandmaster BMCA (Best Master Clock Algorithm) in order of precedence:
 - **Priority 1:** This parameter defines which clocks are allowed to be considered as masters. To be considered as a leader, the value should be set to 128 or less. Priority 1 is the first criteria in the BMCA, so if Priority 1 is set to a lower value than other devices on the system, then it is chosen even if the clock quality is poor. Typically, all the masters in a domain should have the same value for the Priority 1 parameter.
 - **Clock Class:** This value characterizes the TAI (International Atomic Time) traceability. The clock class value varies to indicate the type of reference in use by the Grandmaster clock. For example, when locked to GPS the PTP grandmaster reports a class 6. However, if in holdover mode after locking to GPS, then it reports a class of 7.
 - **Clock Accuracy:** This value characterizes the clock accuracy for the purpose of determining the best leader clock.
 - **Clock Variance:** This value is reported by the PTP leader to indicate the variance of the clock over a one second interval. A lower number indicates a more stable clock and is preferred by the BMCA.
 - **Priority 2:** This parameter is used to break the tie between masters that have the same clock quality. Several values may be used to define a hierarchy of devices. Most profiles use 128 as a default, so a value of 127 or lower would indicate a preferred leader.
- **Clock Source:** The clock source field is not used by the BMCA. The field is set to indicate the type of reference in use by the Grandmaster clock.
- **Communication Mode:** There are three basic message modes for PTP: Multicast, Unicast, and mixed Multicast and Unicast. For full Multicast or Unicast modes, all of the PTP messages are sent in the selected mode type.

Note: The PRISM monitor currently supports Multicast communication mode and SMPTE mixed mode without negotiation. In later firmware releases, other communication modes will be supported.

For some profiles, such as some telecom profiles and the ST2059 profile, a mixture of Multicast and Unicast are allowed. On the SMPTE profile unique mixed mode, the Announce and Sync messages are sent as multicast. However, the Delay request and Delay Response messages are sent as Unicast.

Some points to understand about communication modes:

- Whatever mode is chosen, the leader and follower must match or be compatible.
- Multicast and Mixed modes may need IGMP joins and leaves Full Unicast must have the leader address in all follower AMTs.
- Unicast without negotiation does not allow leader to regulate load.
- Two masters can be used on different domains to serve slaves on different communication modes.

- **Delay Mechanism:** Shows the delay mechanism mode being used:

Note: The PRISM monitor currently supports only the End-to-End delay mechanism.

- **End-to-End:** In this mode, the sync, follow-up, delay-request, and delay-response messages go through the network all the way between the leader and follower. End-to-End mode is useful in PTP networks where some or all devices are not PTP aware.
- **Peer-to-Peer:** In this mode, the Pdelay-request and Pdelay-response messages are local to each link in the network. Each device determines the local link and device delays. The sync message from the leader then collects the corrections as it propagates from the leader to follower. Peer-to-Peer mode is useful in PTP networks where the routing configuration changes. For Peer-to-Peer mode to work well, all of the devices need to be PTP aware.

- **Message rates:**

- **Announce:** Displays the rate of the Announce messages received from the leader. Typical values are 1 to 4 messages a second, but a wide range is allowed by some profiles. If the value is lower than expected, it may indicate a problem in the network or the leader.
- **Sync:** Displays the rate of the Sync messages received from the leader. Typical values are 1 to 16 messages a second, but some profiles allow much higher rates. If the value is lower than expected, it may indicate a problem in the network or the leader.
- **Delay Request:** Displays the rate of the Delay Request messages sent by the follower. In multicast mode, the Delay Request rate is required to be set in response to a field in the Delay Response message from the leader. Typically the leader sets this field such that the Delay Request message rate is equal to the Sync message rate.

Note: For SMPTE mixed mode, PRISM sets the delay Request rate equal to the Sync message rate received from the leader.

- **Delay Response:** Displays the rate of the Delay Response messages received from the leader. Each Delay Request should have a matching Delay Response, so if the value is lower than expected then it may indicate a problem in the network or the leader

NMOS Tab

Select the **NMOS** tab to view the registration server information, server list, and last SDP file received.

To enable and configure NMOS, see [Using NMOS](#).

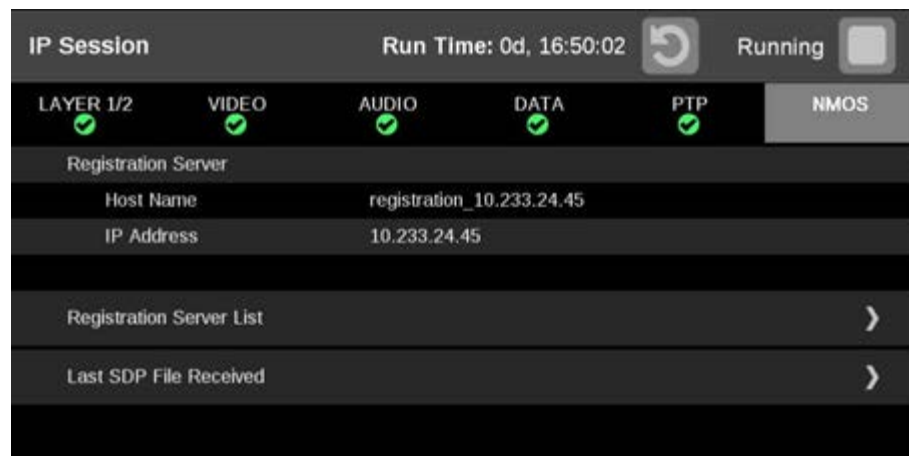

- **Registration Server:** The Host Name row shows the DNS host name when DNS is selected as the NMOS registration method, or “Static IP Address” when Static is selected. The IP Address Status LED is green when PRISM is successfully registered with the server.
- **Registration Server List:** Select the Registration Server List tab to view the Host Name, IP Address, and Priority of the servers registered to this instrument using NMOS.

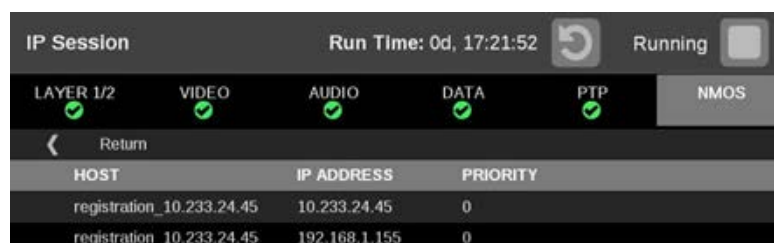

Note: Press **Return** to go back to the main IP Session NMOS menu.

- **Last SDP Files Received:** Select the Last SDP File Received tab to view video, audio, and data SDP files for each NMOS dev. These files contain information used to configure input signals from the registration servers.



Note: Press **Enter** to go back to the main IP Session NMOS menu.

IP Graphs Application

Note: IP Graphs is supported in multi-input mode for the primary channel when IP input is selected.

Use the IP Graphs application to view various graphs that show aspects of the IP stream. As you scroll through the various graphs, the top of the selected graph moves to the top of the display area to help view the complete graph. The displayed graph is included in a saved preset.

Note: Option MP2-IP-MEAS must be installed to use the IP Graphs application.



If ST 2022-7 monitoring is configured, the IP Graphs application includes Path 1 and Path 2. The graph data can be switched between viewing only Path 1, only Path 2, or both by selecting the Path button in the upper right of the screen.

Note: The Path button works only with 2022-7 seamless switching enabled in input configuration.

If ST 2110 monitoring is configured, you can select Video, Audio, and data. For Audio and Data, you can select one stream at a time from the four available streams in the Tile Settings menu.

If ST 2022-6 monitoring is configured, the IP Graphs include:

- **Video CRC Error graph:** The Video CRC Error graph shows any present CRC errors in the currently decoded signal and can be compared to other time graphs such as RTP Sequence Errors.
- **TS-DF graph:** The TS-DF graph shows the Time Stamped Delay Factor, as defined in EBU Tech 3337, which is a method for measuring network jitter in RTP streams.

Configure the IP Graphs Application

1. Select the **Tiles** icon (🧩).
2. Select the tile with the IP Graphs application.
3. Select the **Tile** icon (⚙️).

Note: To move the settings left or right, select the **Move** icon (↔️) in the Settings menu header.

4. From the **Trend Interval** list, select the interval: **1 minute, 5 minute, 10 minute, 30 minute, 1 hour, 3 hour, 6 hour, 12 hour, or 1 day.**

5. From the **Audio** list, select a stream to monitor. The monitored stream is noted in the IP Graphs heading, next to the Stream type button.
6. From the **Data** list, select a stream to monitor. The monitored stream is noted in the IP Graphs heading, next to the Stream type button.



IP Graphs Application Elements

The elements at the top of the IP Graphs application are shared between all graphs.

Note: Only Path 1 displays unless you enable ST 2022-7 Seamless Switching, (see [Configure ST 2022-6](#)).

- **PATH 1** and **PATH 2**: Describes the two information paths.
- **Port**: Shows the physical port used on the instrument.
- **Src**: Lists the source address of the IP stream.
- **Dest**: Lists the destination address of the IP stream.
- **Protocol**: Lists the protocol being used by the monitored stream.
- **PRS**: Shows the Packet Read Schedule (PRS) defined in the input video settings.
- **Clear icon**: Select the **Clear** icon (🔄) to reset the monitoring session.
- **Stream type**: Select this button to change to Video (V), Audio (A), or Data (D) stream IP graphs.
- **Path**: Select the Path button to change to Path 1, Path 2, or both Path 1 and 2.
- **Res**: Lists the resolution of the graph display at the bottom right of the graph.



Total Bit Rate Graph

The Total Bit Rate graph shows the total bit rate currently on the 10/25 GE input. The maximum available bandwidth depends on 10/25 GE input: 10.3Gbps and 25.8Gbps. These readouts appear:

- **Max:** Shows the maximum bandwidth used during the time window.
- **Mean:** Shows the mean bandwidth used during the time window.
- **Min:** Shows the minimum bandwidth used during the time window.
- **Free Min:** Shows the minimum available bandwidth that is not in use.
- **Free Max:** Shows the maximum available bandwidth that is not in use.

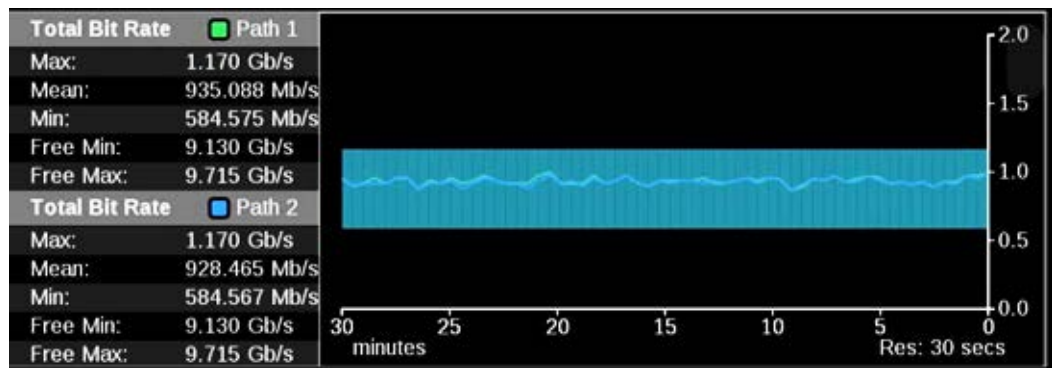

Session Bit Rate Graph

The Session Bit Rate graph shows the data rate of the currently selected input stream.

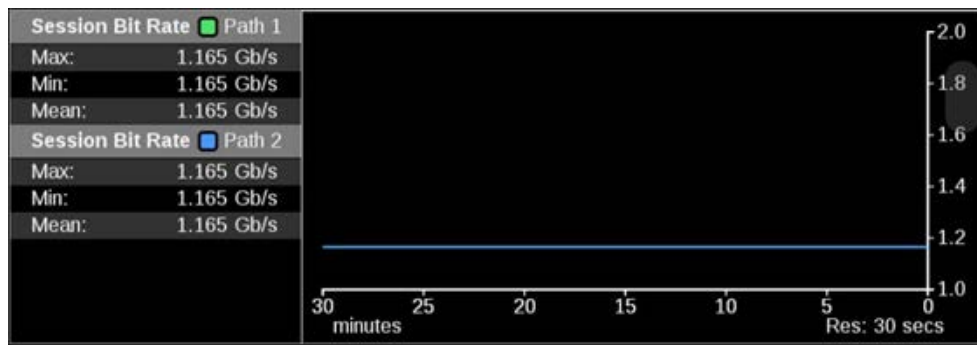

PIT Graph

The PIT (Packet Interval Time) graph shows the difference in arrival time between sequential packets of the active stream. This is one indication of the packet jitter and dropped packet rate. The colored bars represent the range from minimum to maximum for all of the packets within that time interval.

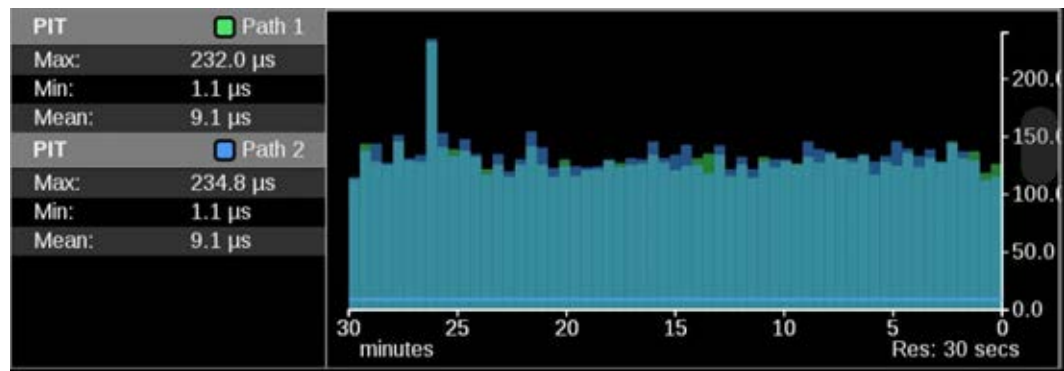

RTP Sequence Error Graph

The RTP Sequence Error section shows the RTP sequence information and indicates whether a packet is received out of order.

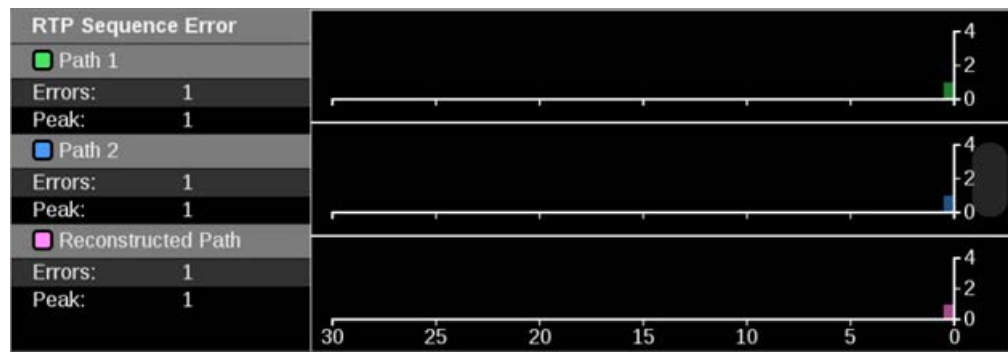

In the Reconstructed Path Errors section, 0 means no sequence errors have been detected, and any number (not 0) means sequence error or errors were detected after RTP packet reordering on each path and ST 2022-7 seamless reconstruction process.

Path1-Path2 Differential Graph

Path Differential represents the time difference between the Path 1 and Path 2 streams in an ST 2022-7 system. As the path differential gets larger, it becomes more difficult for equipment receiving the data to properly process both paths, depending on the size of the input buffer in the equipment.

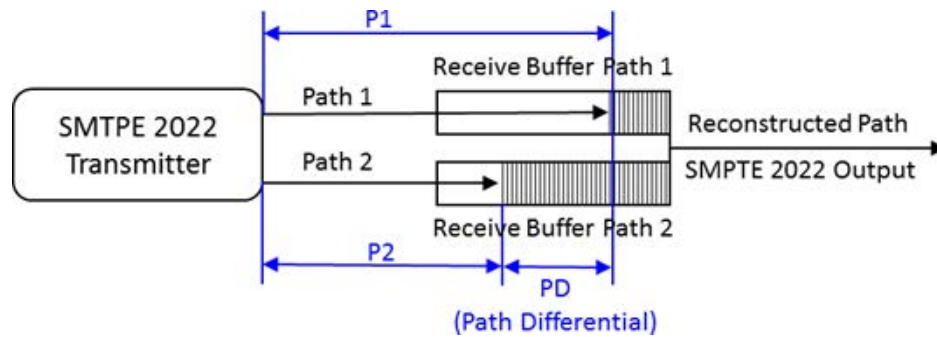

The ST 2022-7 specification defines Path Differential as an absolute value, but the Path1-Path2 Differential graph shows the signed value of Path 1 minus Path 2. A positive value means that Path 2 is lagging Path 1. The ST 2022-7 specification defines Path Differential as an absolute value, but the Path1-Path2 Differential graph shows the signed value of Path 1 minus Path 2. A positive value means that Path 2 is lagging behind Path 1.

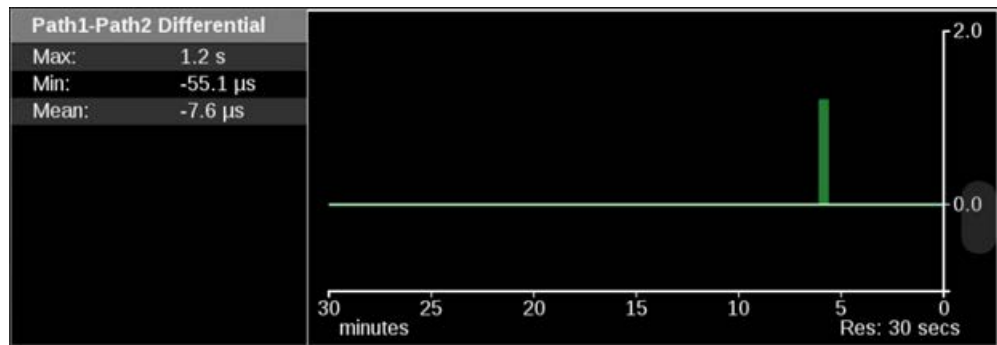

Note: The measurement range of Path1-Path2 differential measurement is 1 second.

The Path1-Path2 differential measurement is not supported for ST 2110-30.

CMAX and VRX Buffer Graph

ST 2110-21 specifies a timing model for ST 2110-10 video RTP streams with these parametric models:

Note: The CMAX and VRX trend graphs are not available for streams 525i 59.94 and 650i 50. The graphs are also not available on SFP 2.

Make sure the input signal and PRISM are locked to PTP for these measurements.

- A network compatibility model to regulate the burst characteristics of senders, which promotes the compatibility with the switches. The CMAX section provides a trend graph for this type of modeling.

- A virtual receiver buffer model to ensure there is no buffer overflow or underflow in the receiver that could cause the packet loss and picture quality degradation. The VRX Buffer section provides a trend graph for this type of modeling.

Both trend graphs help engineers properly setup the packet delivery timing in the RTP packet sender.

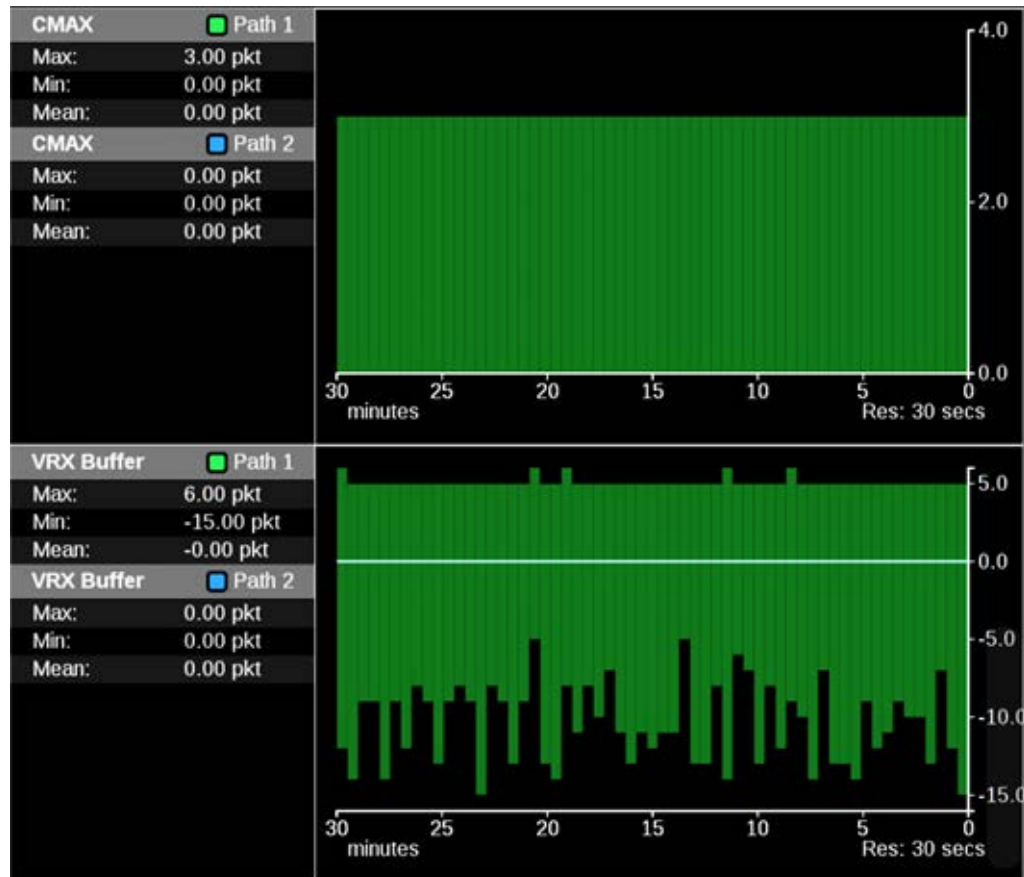

PIT Histogram Application

Note: PIT Histogram is supported in multi-input mode for the primary channel when IP input is selected.

Use the PIT (Packet Interval Time) Histogram application to monitor the network delay variation statistics. The application is available only in the 200 and 300 versions of MPS, MPD, and MPP.

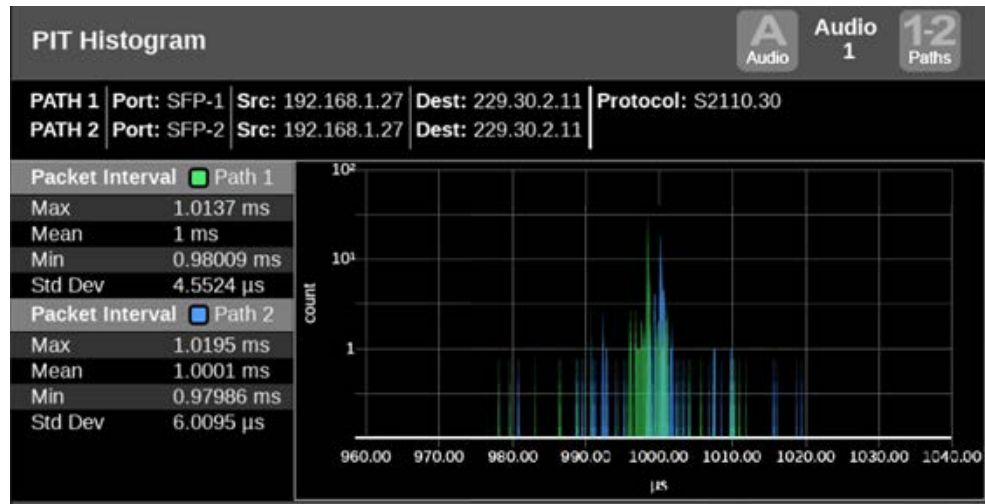

Note: If ST 2110 monitoring is configured, you can select Video, Audio, or Data (one stream at a time, selectable in Tile Settings).

Configure the PIT Histogram Application

1. Select the **Tiles** icon (🧩).
2. Select the tile with the PIT Histogram application.
3. Select the **Tile** icon (⚙️).

Note: To move the settings left or right, select the **Move** icon (↔️) in the Settings menu header.

4. Select a **Y-Axis** scaling option: **Linear** or **Log**.
5. From the **Audio** list, select the audio stream to monitor. The selected audio stream is noted in the PIT Histogram heading next to the monitored path.

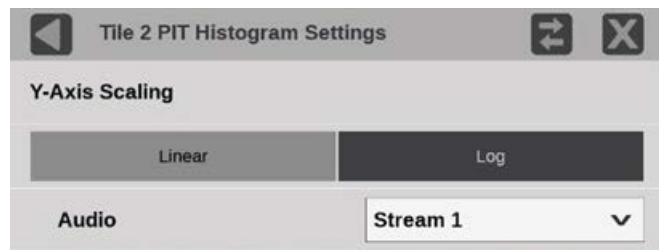

PIT Histogram Elements

- **Port 1** and **Port 2:** Shows the physical ports on the instrument.
- **Src/Dest:** Lists the source and destination addresses of the IP stream.

- **Protocol:** Lists the protocol being used by the monitored stream.
- **Path:** Select the button, in the top-right corner of the tile, to switch between Path 1 only (green), Path 2 only (blue), or both Path 1 and Path 2 data (cyan where Path 1 and 2 are overlapped).

Note: The Path button works only with ST 2022-7 seamless switching enabled in input configuration.

- **Stream type:** Select to switch between the video, audio, or data stream IP graphs.

Note: The Stream Type button is available only with ST 2110 streams.

Packet Interval information:

- **Max:** Shows the maximum packet interval time.
- **Mean:** Shows the mean packet interval time.
- **Min:** Shows the minimum packet interval time.
- **Std Dev:** Shows the standard deviation of the packet interval time.

Use the pinch and pinch-out gestures on the graph to zoom in and out. After using the zoom-in gesture, the text “Zoomed” is displayed on the bottom of the graph.

Note: When using a keyboard and mouse, click-and-drag to zoom in.

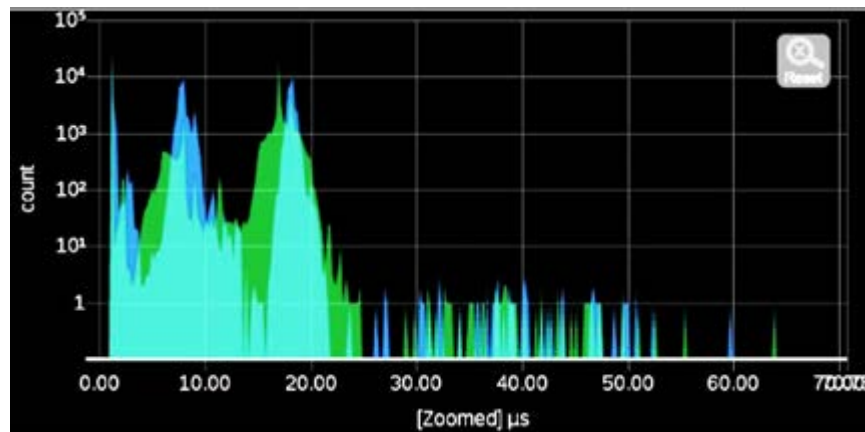

Select the **Reset** button () to set the graph back to autoscale mode.

Note: The Reset button is displayed only after zooming in.

PTP Graphs Application

Use the PTP Graphs application to monitor the message timing between leader and follower in a PTP network.

For more information on PTP operations and settings, see [Configure Reference Settings](#) and [PTP Introduction](#).

Note: Option MP2-IP-MEAS must be installed to use the PTP Graphs application.

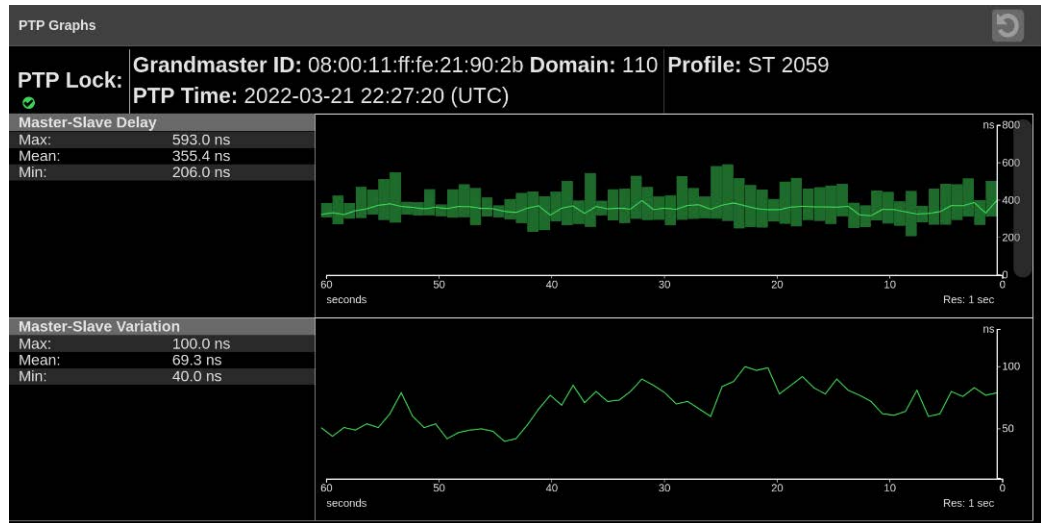

Configure the Open PTP Graphs Application

1. Select the **Tiles** icon (🧩).
2. Select the tile with the PTP Graphs application.
3. Select the **Tile** icon (⚙️).

Note: To move the settings left or right, select the **Move** icon (↔️) in the Settings menu header.

4. From the **PTP Trend Interval** menu, select the interval. The PTP Trend Interval defines the extent of the horizontal axis on the graph.

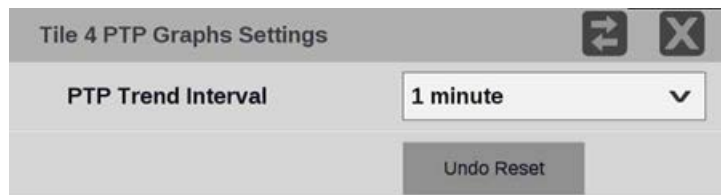

PTP Graph Elements

The PTP graphs are useful in observing the effects of traffic on the PTP messages and the operation of transparent and boundary clocks. Non-PTP aware switches may have significant PTP delay variations, while transparent and boundary clocks have much less variation and total delay.



- **PTP Lock:** Shows the status of the PTP lock.
 - **Grandmaster ID:** Displays the reference Source and Domain.
 - **Domain:** Can be changed in **Settings** icon (⚙️), in **Reference**.
 - **Profile:** Shows the profile that has been selected in the Reference Settings menu. This is not detected from the incoming PTP messages.
 - **PTP Time:** Time of day derived from the PTP signals.
 - **Res (Resolution):** Shows the time increment for each bar on the display. Longer graph settings collect data into larger bins to be displayed. This range and resulting resolution are selected in the setting menu for PTP graphs.
- **Trace Types:** There are four displays available. For each one, the Max., Min., and Mean (average) are shown on the left, while the traces versus time is shown on the right. The traces indicate the Max, and Min envelope, and the Mean (average) for each time bin. The time scale can be adjusted in the Settings menu. The data is logged for 1 day so you can go back and look at long-term trends.

Use the control to move the displays up or down.

 - **Leader-Follower Delay:** This graph indicates the difference in the timestamps for the PTP Sync messages; these go from the leader to the follower. This display indicates effects of the downstream network delay and adjustments made to the follower clock. After the follower is locked and the timing is stable, the

perturbations on this graph are largely due to network variations. Traffic often causes some messages to be delayed so the maximum delay increases.

As the PTP is locking, the follower clock adjusts, so the trace may have large swings or jumps. As the system locks, the leader-to-follower and follower-to-leader delays should converge on the same value. This value represents the average network delay between the leader and follower for the traffic in both directions.

If the network delay is too unstable, then the PTP might never lock. This appears as large variations on this trace.

- **Leader-Follower Variation:** The leader-to-follower variation graph is derived from the same data as the leader-to-follower delay. The absolute value of the changes in delay are filtered according to RFC1889 and displayed. This display then shows a measure of the variation of the network delay. A low value indicates a PTP follower is likely to quickly lock, a large value indicates it could be difficult for a PTP follower to lock.
- **Follower-to-Leader Delay:** This graph indicates the difference in the timestamps for the PTP Delay Request messages that go from the follower to the leader. This display indicates effects of the upstream network delay and adjustments made to the follower clock. After the follower is locked and the timing is stable, the perturbations on this graph are largely due to network variations. Traffic often causes some messages to be delayed so the maximum delay increases.

As the PTP is locking, the follower clock adjusts, so the trace may have large swings or jumps. As the system locks, the leader-to-follower and follower-to-leader-delays should converge on the same value. This value represents the average network delay between the leader and follower for the traffic in both directions.

If the network delay is too unstable, then the PTP might never lock. This appears as large variations on this trace.

- **Follower-to-Leader Variation:** The leader-to-follower variation is derived from the same data as the leader-to-follower delay. The absolute value of the changes in delay are filtered according to RFC1889 and displayed. This display then shows a measure of the variation of the network delay. A low value indicates a PTP follower is likely to quickly lock. A large value indicates it could be difficult for a PTP follower to lock.
- **PTP Phase Lag:** The graph shows the error in the follower clock phase as measured by the PTP timestamps. This value is used to adjust the follower clock to drive the error toward zero.

The PTP phase lag is the phase error of the phase-locked loop, which controls the follower clock. The phase lag is a reasonable estimate of how well the PTP follower is locked to the leader; however, the phase lag does not indicate if there is any asymmetry in the network.

Stream Timing Application

Note: Stream Timing is supported in multi-input mode for the primary channel when IP input is selected.

The Stream Timing application shows the timing of the video, audio, and data as it was received relative to the embedded RTP timestamps. It also shows the relative delay between Audio/Video and the Data/Video, which is the amount of delay needed to realign the two essence types.

Note: The Stream Timing application requires Option MP2-IP-MEAS.

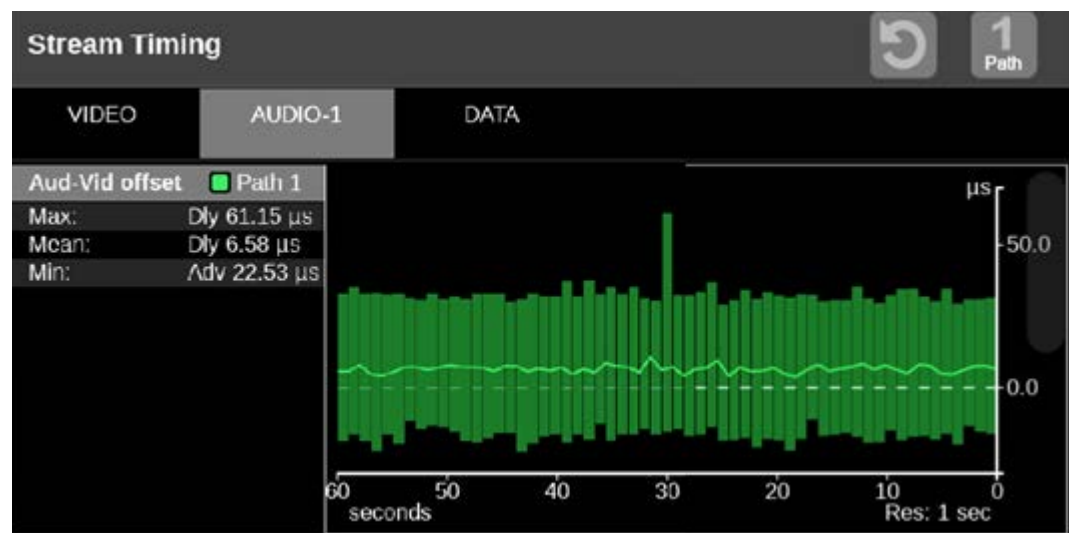

Configure the Open Stream Timing Application

1. Select the **Tiles** icon ().
2. Select the tile with the Stream Timing application.

3. Select the **Tile** icon (⚙️).

Note: To move the settings left or right, select the **Move** icon (↔️) in the Settings menu header.

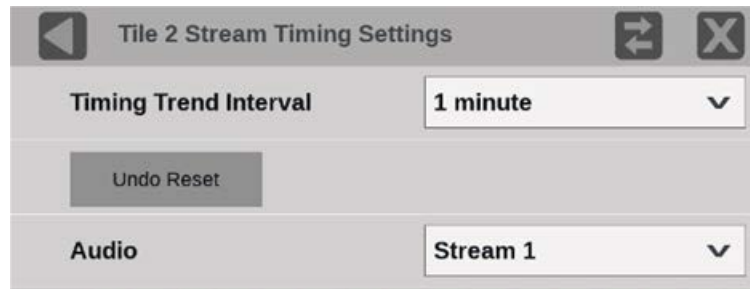

4. Select the **Timing Trend Interval** menu and select the interval.

To undo the last clear or reset of the monitoring session, select **Undo Reset**.

5. Select the Audio menu and choose the audio stream to monitor. The selected stream is noted in the AUDIO tab label.

Stream Timing Elements

The elements at the top of the Stream Timing application are shared between all graphs:

Note: Only Path 1 displays, unless you enable ST 2022-7 Seamless Switching. (See [Configure ST 2022-6.](#))

- **Clear:** Select the **Clear** icon (✕) to reset the monitoring session.
- **Path:** Select the Path button to switch between Path 1, Path 2, or both Path 1 and Path 2.
- **Stream type tabs:** Select these tabs to switch between the stream offset graphs:
 - VIDEO
 - AUDIO

Note: The number in the AUDIO tab is the selected stream.

- DATA
- **Res:** Lists the resolution of the graph display.

Video Offset Tab

This tab has options to see the timing and data between the video stream and PTP or RTP offset.

Vid-PTP

The graph shows the relative delay between video stream and PTP. This value indicates the amount of delay that must be applied to realign the video and PTP according to the timestamps. This is a time-based graph of the Timing Display application.

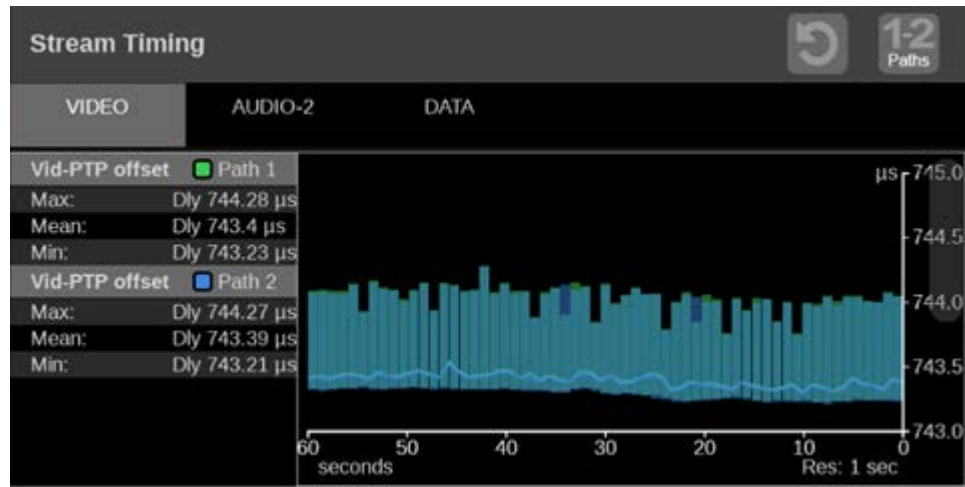

Vid-RTP Offset

The graph shows timing of the video stream as it was received relative to the embedded RTP timestamps.

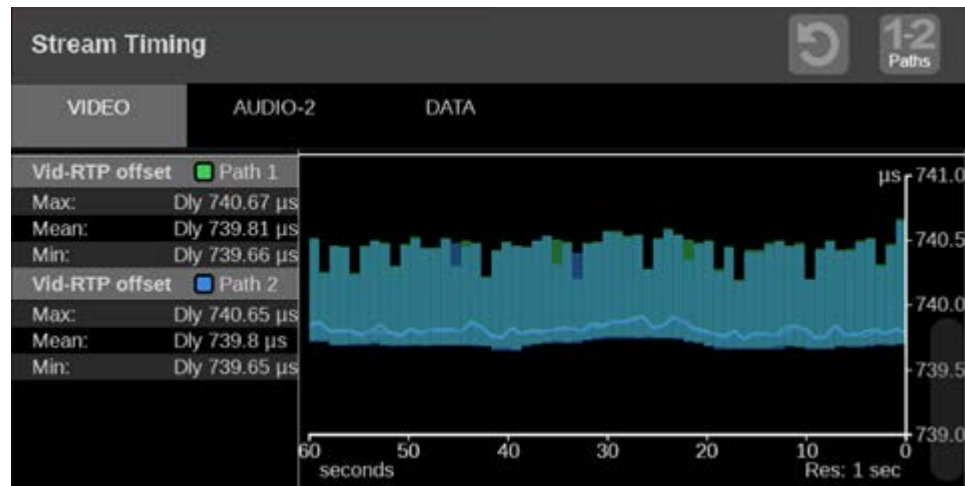

Audio Offset Tab

Select the Audio Offset tab to view the timing and data between the audio stream and video stream or RTP offset.

Aud-Vid Offset

The Aud-Vid Offset graph shows the relative delay between audio and video streams. This value indicates the amount of delay that must be applied to realign the signals according to the timestamps.

Note: The selected stream is indicated in the Audio tab as <1-4>.

The audio measurements are logged to a single graph. If you change the audio stream being monitored, we recommend resetting the graph to only see the measurements relative to the current stream.

To change the monitored stream:

1. Select the **Tile** icon () and select the **Audio** menu.
2. Select the stream to monitor.

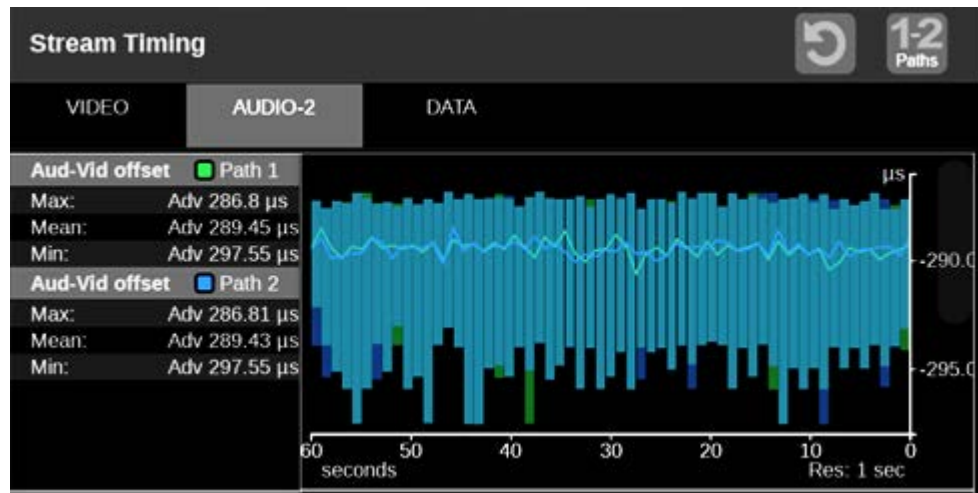

Aud-RTP Offset

The Aud-RTP Offset graph shows timing of the audio stream as it was received relative to the embedded RTP timestamps.

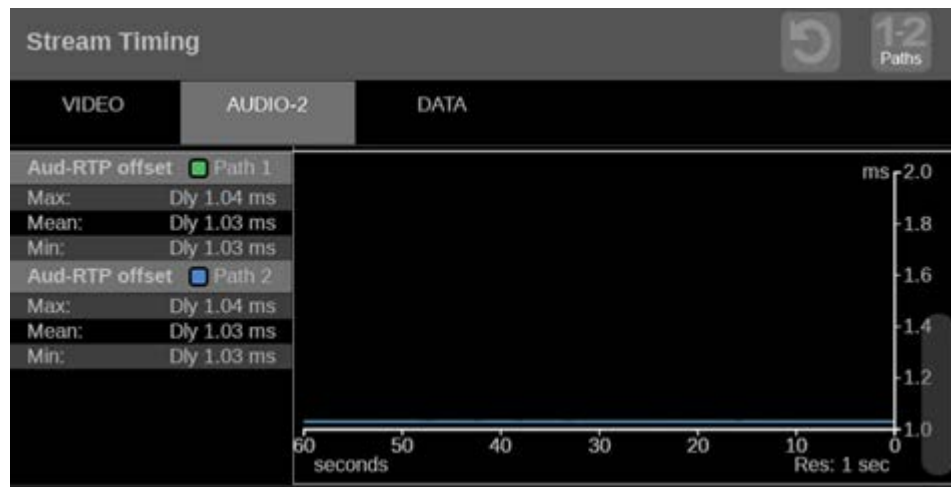

Data Offset Tab

Select the Data Offset tab to view the timing and data between the data stream and video stream or RTP offset.

Data-Vid Offset

The graph shows the relative delay between data and video streams. This value indicates the amount of delay that must be applied to realign the signals according to the timestamps.

Note: The selected stream is indicated in the Data tab as <1-4>.

The data measurements are logged to a single graph. If you change the data stream being monitored, we recommend resetting the graph to only see the measurements relative to the current stream.

To change the monitored stream:

1. Select the **Tile** icon () and select the **Data** menu.
2. Select the stream to monitor.

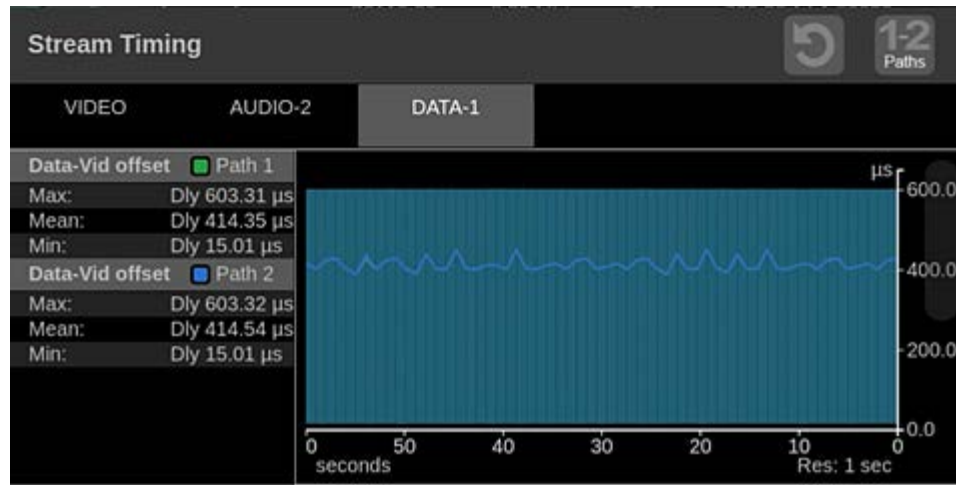

Data-RTP Offset

The Data-RTP Offset graph shows timing of the data stream as it was received relative to the embedded RTP timestamps.

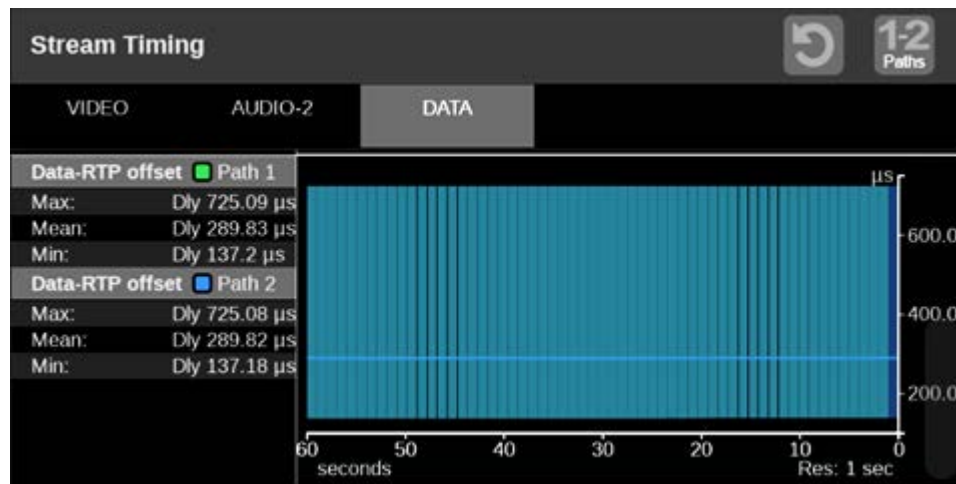

ANC (Ancillary Data) Session Application

Note: In multi-input mode, ANC Session works only with the primary channel.

The ANC Session application allows you to examine all the ancillary data present in a signal. The instrument continually monitors the signal and tells you when changes in the presence of data occur.

Select the **Clear** icon (🔄) to reset the monitoring session for both the WATCH LIST and the SCTE104 pages.

Note: PRISM monitors the first four links of the eight logical SDI links in Quad Link 3G LB and Quad Link 12G.

WATCH LIST Tab

Select the **Watch List** tab to view a list of detected ANC data. The Watch List tab also reports the last detected time, so infrequent ANC data, such as SCTE-104, can be monitored in the Occurrence column. The Line/Sample information, in conjunction with Datalist display, helps you diagnose the ANC data at the bit level.

- **STRM:** The 21 10-40 or 43 stream number.
 - **DID:** Data identifier of the packet, permissible values range from 1 to 0xFF (255) inclusive.
 - **SDID:** Secondary data identifier of the packet, permissible values range from 0 through 0xFF (255) inclusive.
 - **LINK:** This is the virtual link or stream the ANC data is present on.
 - **LOCATION(S):** This is the transport line number the ANC data is present on.
 - **OCCURRENCE:** Shows the last time a packet occurred.
- NOTE:** Shows the basic information about the ANC data, like time code or summary of SCTE104.

WATCH LIST		SCTE104				
NAME	DID	SDID ▲	LINK	LOCATION(S)	OCCURRENCE	NOTE
✓ S352M VPID	41	1	C	Line 10 Sample 1939	Field	89 ca 00 01
✓ Type 2	42	1	C	Line 10 Sample 1928	Field	
✓ S352M VPID	41	1	Y	Line 10 Sample 1939	Field	89 ca 00 01
✓ Type 2	42	1	Y	Line 10 Sample 1928	Field	
✓ S299-1 Ctrl Grp 1	E3	--	Y	Line 9 Sample 1928	Field	48kHz PP-- Frn



Note: A green checkmark in the WATCH LIST name column means data is being continuously received. A yellow exclamation mark means data has been received but it has stopped.

SCTE104 Tab

Select the **SCTE104** tab to view Multiple Operations Messages, and the RTC / TC (Real Time Clock/Time Code) section displays the reception time of ANC packets that have SCTE104 data. You can review the last 10 messages to check whether the message sequence is correct.

Select the **Run** button (▶) to start the data stream.

Select the **Pause** button () to pause the data stream.



Note: When the **Run** button () is visible, it means data monitoring-collecting is paused. When the **Pause** button () is visible, it means data collecting-monitoring is running.

Multiple Operation Codes and Titles

Op Code	Op Title
0x0101	splice_request_data()
0x0102	splice_null_request_data()
0x0104	time_signal_request_data()
0x0109	insert_DTMF_descriptor_request_data()
0x010A	insert_avail_descriptor_request_data()
0x010B	insert_segmentation_descriptor_request_data()
0x010C	proprietary_command_request_data()



Note: The RTC (real-time clock) and TC (time code) numbers on the Scte104 page match the RTC and TC in the PRISM status menu.

The number in the left column of the Scte104 page is the number of operations received. Select the **Plus** icon () or **Minus** icon () to scroll through the list of up to the last 10 received messages.

Received messages that are marked as duplicates (ST2010 header of 0x09) display “Duplicate” instead of Multiple or Single Operation. “Duplicate” is also marked in the Event Log.

Datalist Application

Note: In multi-input mode, Datalist works only with the primary channel.

You can view digital data in SDI frames for select HD, 3G Level A, and single-link 12G formats to perform in-depth monitoring and analysis of incoming SDI data.

Supported Datalist Formats





Link	Format	Sample Structure		Bits	Frame/Field Rate	Audio	Option
HD-SDI	1920x1080	4:2:2	YCbCr	10b	50/59.94/60i, 23.98/24/25/29.97/ 30p, and psF	16ch	Standard
3G-SDI Level A	1920x1080	4:2:2	YCbCr	10b	50/59.94/60p	16ch	Standard
12G-SDI	3840x2160	4:2:2	YCbCr	10b	50/59.94/60p	16ch	FMT-4K

Note: 4K Quad Link signals can be monitored by looking at the individual links as separate inputs.

Datalist requires software option MP2-ENG or MP2-QC.

The Datalist display shows the digital data from the selected SDI input. It is updated approximately once per second, and updating can be controlled by selecting the **Run/ Pause** button in the application banner.

While the application is running or paused, you can scroll through the SDI data using a touchscreen or mouse. Scroll vertically by touch-swipe or use the mouse scroll wheel. Scroll horizontally by touch-swipe or click-and-drag with the mouse. Alternately, the described navigation controls can be used.

Note that the navigations controls are available only in Half-Screen and Full-Screen modes. The **Half-Screen** icon () expands the tile vertically. If the tile expands, it covers the tile above or below, depending on whether you are expanding the top or bottom tile. The **Reduce** icon () turns the tile to quarter-screen size. Similarly, the **Full-Screen** icon () expands the tile vertically and horizontally. The **Reduce** icon () returns the tile to the previous mode.

The color map for the various types of data is as follows:

XXX	EAV/SAV	XXX	ANC Data UDW
XXX	LN/CRC	XXX	ANC Data Checksum
XXX	HBLANK	XXX	Code Word Warning
XXX	VBLANK	XXX	Code Word Violation
XXX	Switching Line	XXX	Active Y
XXX	ANC Data	XXX	Active C

Within the application, you can select the **Question Mark** icon (?) to view the color map.

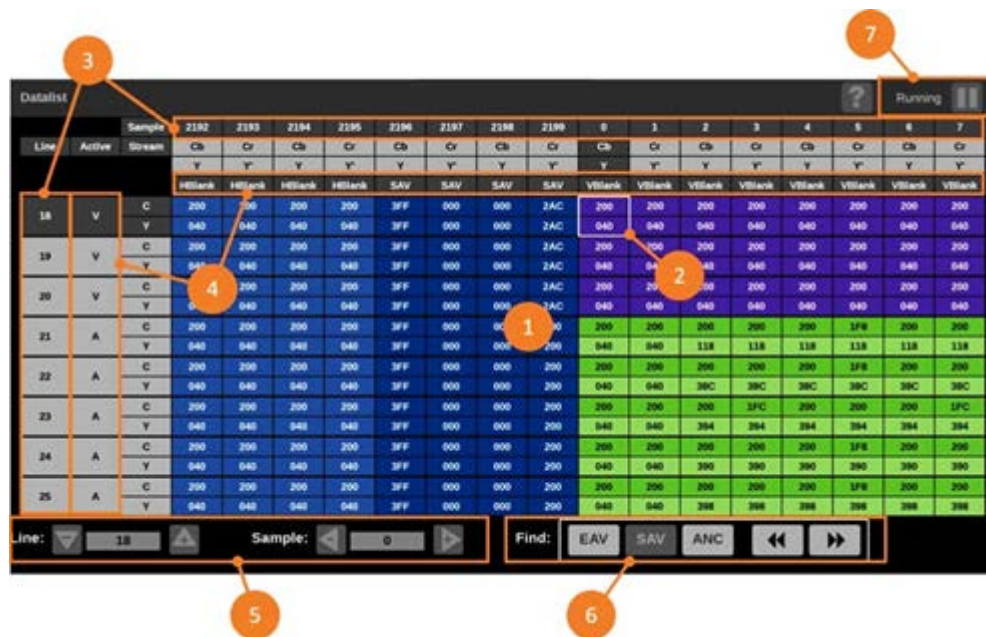

The following table describes each item.

Item	Description
1	SDI frame data: The SDI frame data is color coded for easier identification. Select the ? icon in the application banner for help in decoding the SDI data types.
2	Selected SDI sample: The SDI sample that is selected by the Line and Sample controls at the bottom of the application.
3	Line and sample numbers.
4	Line and sample data types.

Item	Description
5	Line and sample selection: Use these controls to go to a specific sample and line. The number can be entered directly by selecting the current number; this displays a keyboard. Enter the line or sample number and select Enter to go to that location.
6	SDI frame shortcuts: Use these controls to go to the next EAV, SAV, and ANC location after the selected SDI sample. For example, to go to the next SAV location, select the SAV button and then select the Fast Forward button.
7	Run/Pause control: Select this button to run and pause the SDI frame updates. Pausing allows you to examine a single SDI frame in more detail.

Timing Application

Note: In multi-input mode, Timing works only with the primary channel.

The Timing application uses a reference to evaluate the timing of the input of single-link SDI, quad-link SDI, or IP formats (ST 2022-6 or 2110-20). The timing of the input is compared to the expected frame time according to the reference alignment.



SDI versus Black Burst is available in standard. SDI versus PTP, IP versus PTP, Black Burst versus PTP requires Option MP2-IP-MEAS.

For analog references (Black Burst or Tri-Level sync), the relative position of the horizontal and vertical sync pulses are compared to the input signal. In the case of PTP, the current time is obtained and compared to the SMPTE Epoch. When an input is configured for ST 2022-7-style redundant streams, circles for Path 1 (green) and Path 2 (blue) appear; otherwise, only a single path appears. When the input signal is fully aligned with the reference, both circles are in the center of the display indicated by the + symbol.

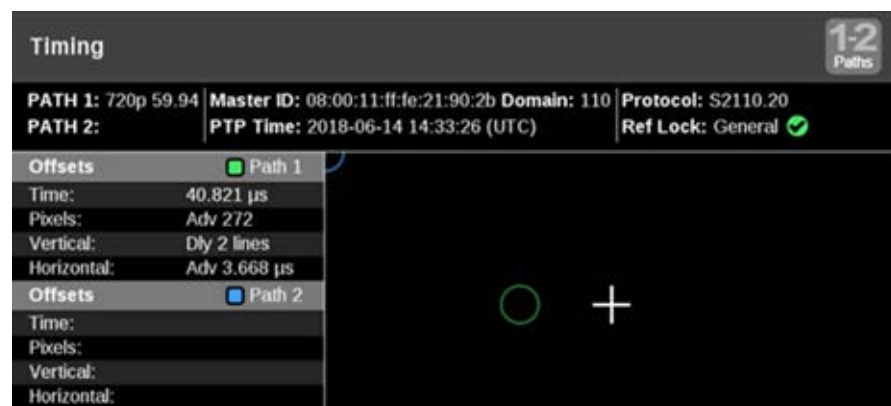
Note: PTP must be locked to use the Timing application with PTP references.



Configure the Timing Application

1. Select the **Tiles** icon ().
2. Select the tile with the Timing application.
3. Select the **Tile** icon ().

Note: To move the settings left or right, select the **Move** icon () in the Settings menu header.

4. Use the menu to change the measurement mode between options.
 - **Video to Reference:** The input video signal (SDI or IP) is compared relative to the reference input (analog or PTP).
 - **Analog to PTP:** Used in a hybrid system to compare the analog reference to the PTP reference to ensure synchronization.



Compare Analog Reference with PTP

1. If not already done, choose the Setting References. See [Choose External Reference](#).
2. In the **Timing Settings** menu, select **Analog to PTP**.

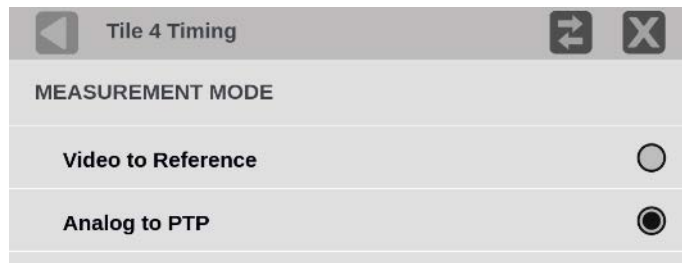

The Timing application compares the Analog to PTP.

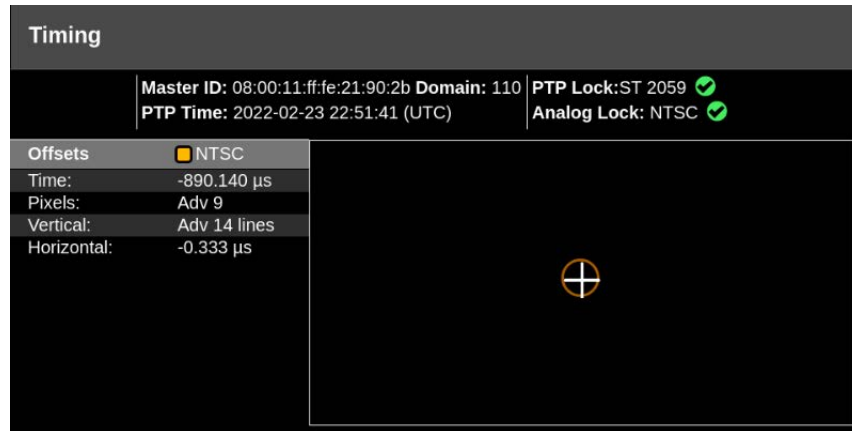



Timing Elements

The Timing elements are as follows:

- **Path 1** and **Path 2**: Displays the IP video format if an IP input signal is selected.

Note: You can switch between Path 1, Path 2, or both Path 1-2 using the Path button at the top right of the application display.

- **Leader ID** and **Domain**: Displays the reference Source and Domain.
- **PTP Time**: Time of day derived from the PTP signals.
- **Protocol**: Displays the input protocol.
- **Ref Lock**: A  (check in green) indicates the PRISM is locked to the reference. A  (x in red) indicates the PRISM is not locked to the reference.
- **Reference Indicator**: A crosshair indicator centered in the display represents the reference signal.
- **Circle**: The circle represents the timing of the input signal. A signal that is early is above or to the left of the crosshair. A signal that is late is below or to the right.
- **Offset**: The difference in timing between the input and reference. A positive number, or “delayed” value, means the input occurs after the reference. A negative number, or “advanced” value, means the input occurs before the reference.
 - **Time**: The total difference in frame timing between the input and reference
 - **Pixels**: The timing difference between the reference and input signal, expressed as in pixels, instead of time units, after the vertical offset has been removed. This has a range of $\pm 1/2$ line for the input format.
 - **Vertical**: The timing difference between the reference and input signal, expressed as the number of lines of delay for the input video format. This has a range of $\pm 1/2$ field for progressive signals and $\pm 1/2$ frame for interlace signals.

- **Horizontal:** The timing difference between the reference and input signal, expressed as the line time, which remains from the total delay after the vertical offset has been removed. This has a range of $\pm 1/2$ a line for the input format.

Additional offset displays are available for Quad Link SDI signals.

- **Link Offsets:** Time delays of Links B, C, and D relative to Link A. These time delays are also shown graphically under the timing display window.
- **Max Link Offset:** Maximum time delay between any two links.



Timing Offsets for IP Signals

Because ST 2022-6 streams are complete SDI signals encapsulated in IP, the timing measurement treats these IP signals as if they were SDI. So the timing system detects the start of the IP frame, then extrapolates to the 0 h point of the encapsulated SDI. Then using PTP as the reference, the ideal alignment point for that frame rate is calculated based on the PTP epoch. Finally, the offset between the ST 2022-6 signal and the ideal alignment is displayed. The display shows both absolute time and the time parsed into lines or horizontal delay as time and pixels.

For ST 2110-20 streams, the Timing application displays the time of the first packet of the frame. Since ST 2110 does not include blanking, the first packet is nominally coincident with the first active line in the SDI raster. This means it is normal for the ST 2110 streams to be delayed by the lines in the vertical blanking of a given format. This value varies by format: HD (21 lines), 3G (42 lines), 4K/UHD (84 lines). According to ST 2110-21, both gapped and linear flows should have the start of frame delayed by the equivalent of vertical blanking.

Use Cases for Measuring Timing

One use case for the Timing application is to measure the delay in a gateway and network. If a properly timed SDI signal is applied to a gateway, then the timing measurement on the resulting IP flow displays the combined latency in the gateway and the network.

Each ST 2110 stream also carries timestamps. The Stream Timing application allows for the analysis of these timestamps.

Eye Application

Note: In multi-input mode, Eye works only with the primary channel.

The Eye application presents an eye pattern diagram of the SDI signal to verify electrical characteristics of the SDI transport layer. Use this application to make automated eye measurements on SD, HD, and 4K SDI signals. This application is available only in the 300 version of MPS, MPD, and MPP. The software option MPSPD-FMT-4K enables 12G-SDI support. This application is valid only on SDI 1.

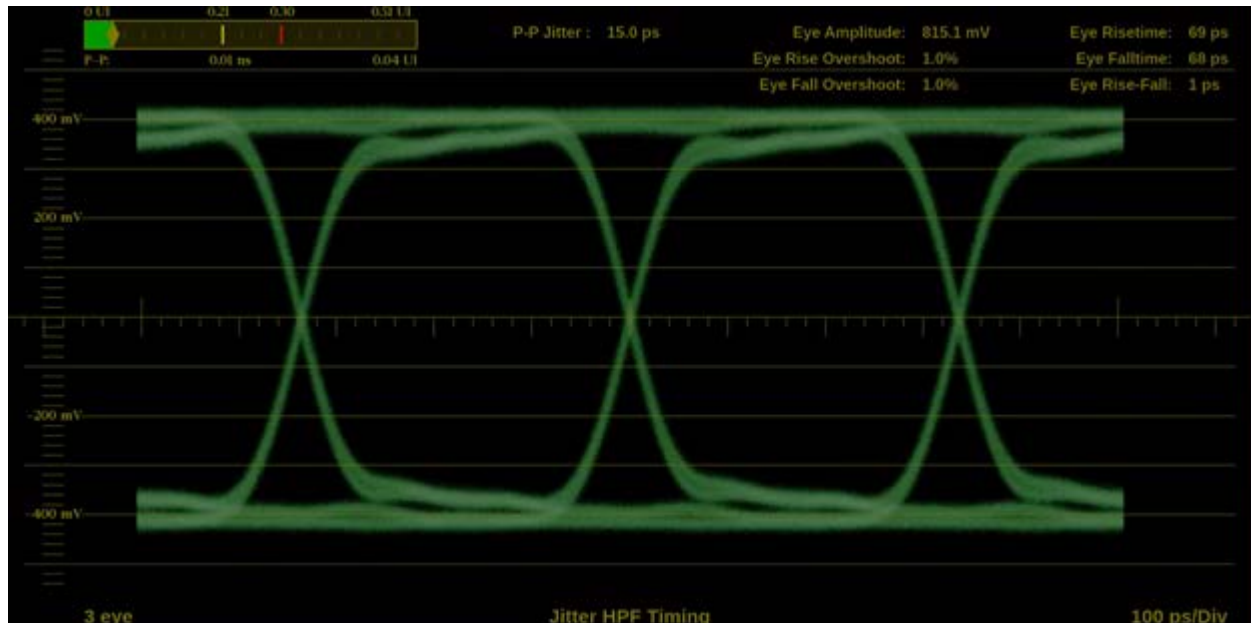

When the application is in full-screen mode, a data display is visible. The information can be moved anywhere in the tile. Select the text and drag it to a new location.

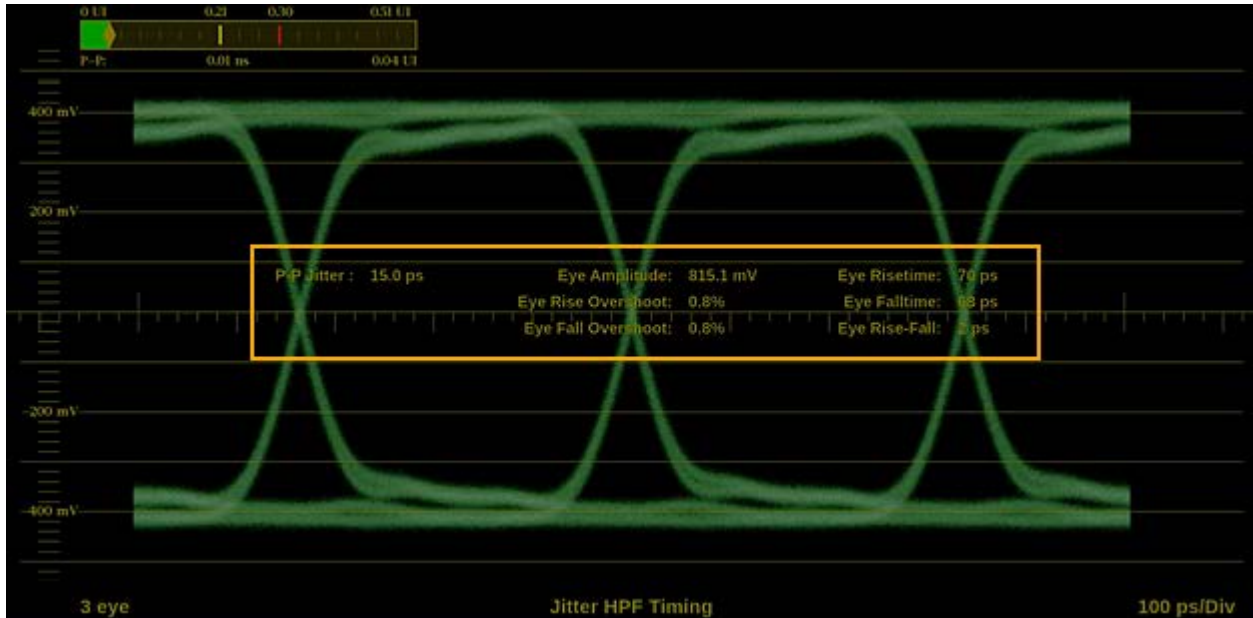

Configure the Eye Display Application

1. Select the **Tiles** icon ().
2. Select the tile with the Eye application.
3. Select the **Tile** icon ().

Note: To move the settings left or right, select the **Move** icon () in the Settings menu header.

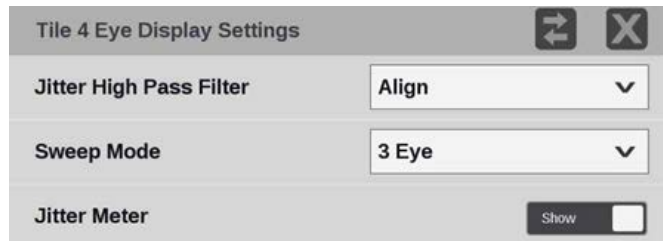

4. From the **Jitter High Pass Filter** list, select the high pass filter: **Timing, Align, 10 Hz, 100 Hz, 1 kHz, 10 kHz, or 100 kHz.**

Note: For multipiece displays, the filter setting applies to both pieces.

5. From the **Sweep Mode** list, select **3 Eye, 10 Eye, 1 Field, or 2 Field.**
6. Set **Jitter Meter** to **Show** to turn on the jitter meter above the eye pattern.

Eye measurements (eye amplitude, eye risetime, eye falltime, eye rise-fall, eye rise overshoot, eye fall overshoot, and P-P jitter) are displayed when the Eye application is in full-screen mode. The display can be moved by selecting and dragging it.

Jitter Application

Note: In multi-input mode, Jitter works only with the primary channel.

The Jitter Display application shows the wave shape of the jitter and allows you to view additional time-domain information, such as whether there are jitter components that are synchronous or nearly synchronous to the video line or frame.

Note: This application requires hardware option PHY and software Option MP2-FMT-4K to enable 12G-SDI. This application is only valid on SDI 1.



When the application is in full-screen mode, a data display is visible. The information can be moved anywhere in the tile. Select the text and drag it to a new location.

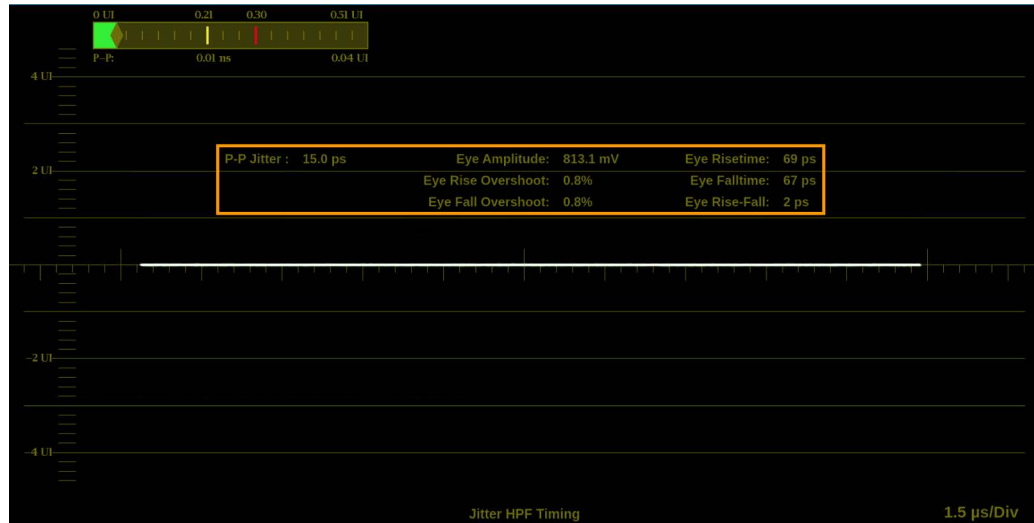

To configure the Jitter Display settings:

1. Select the **Tiles** icon (🗄️).
2. Select the tile with the Jitter application.
3. Select the **Tile** icon (⚙️).

Note: To move the settings left or right, select the **Move** icon (↔️) in the Settings menu header.



4. From the **Jitter High-Pass Filter** list, select the high pass filter: **Timing, Align, 10 Hz, 100 Hz, 1 kHz, 10 kHz, or 100 kHz**. Depending on the format, Timing typically uses the 10 Hz filter and Align uses the 1 kHz or 100 kHz filter.
 - From the **Sweep Mode** list, select **1 Line, 2 Line, 1 Field, or 2 Field**.
 - Set **Jitter Meter** to **Show** to turn on the jitter meter at the top of the tile.

Note: Eye measurements (eye amplitude, eye risetime, eye falltime, eye rise-fall, eye rise overshoot, eye fall overshoot, and P-P jitter) are displayed when the Jitter Display application is in full-screen mode.

Audio-Video Delay Application

The Audio-Video Delay display shows any difference between the video signal and the timing of the audio. The measurement uses the video signal as the 0 line in the display and if the audio signal is in advance or delayed of it. The thresholds for the audio occurring before or after the video can be set. If the audio signal is outside of either limit (later than the delay threshold or before the advance threshold), the display shows a yellow bar.

Note: The application can monitor up to 16 channels.

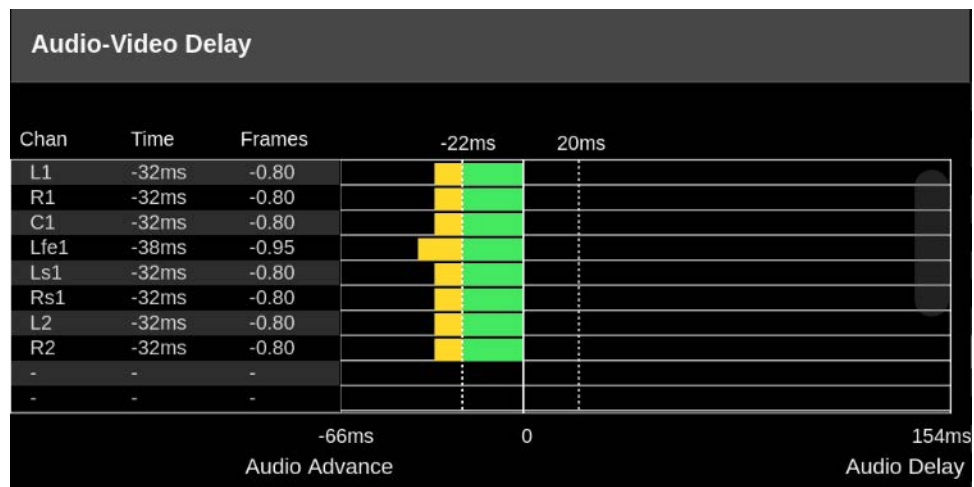

Note: This application requires a test-signal source with an AV timing mode enabled from a Telestream device such as the TG8000, SPG8000A, or SPG9000.

Configure the Audio-Video Delay Application

1. Select the **Tiles** icon (🧩).
2. Select the tile with the Audio-Video Delay application.
3. Select the **Tile** icon (⚙️).

Note: To move the settings left or right, select the **Move** icon (↔️) in the Settings menu header.



4. The Advance Threshold number is the time the audio test signal can arrive before the visual test signal arrives (to the left of the 0 line) and not register as an error; that is, the channel is green in the display. To change the Advance Threshold number, in the **Advance Threshold** box, type the number or select the up or down arrows.

Note: The number in the menu is shown as positive, but in the display it is marked as negative, such as -22, and is only to the left of the 0 line.

5. The Delay Threshold number is the time the audio test signal can arrive *after* the visual test signal arrives (to the *right* of the 0 line) and not register as an error; that is, the channel is green in the display. To change the Delay Threshold number, in the **Delay Threshold** box, type the number or select the up or down arrows.
6. The User Offset allows moving the 0 line in advance or delay of the visual test signal arrival. Set **Apply Offset** to **On** to turn on the offset. The offset setting is on the top right of the tile.
7. To change the Apply Offset number, in the **User Offset** box, type the number or select the up or down arrows.
 - A positive number in the field moves the 0 line to the left of the incoming signal, so the signal arrives in advance. The Time and Frames measurements are positive.
 - A negative number in the field moves the 0 line to the right of the incoming signal, so the signal arrives delayed. The Time and Frames measurements are negative.

The following example shows an offset of 10 ms Advanced, making the correctly timed visual test signal appear to arrive 10 ms delayed.

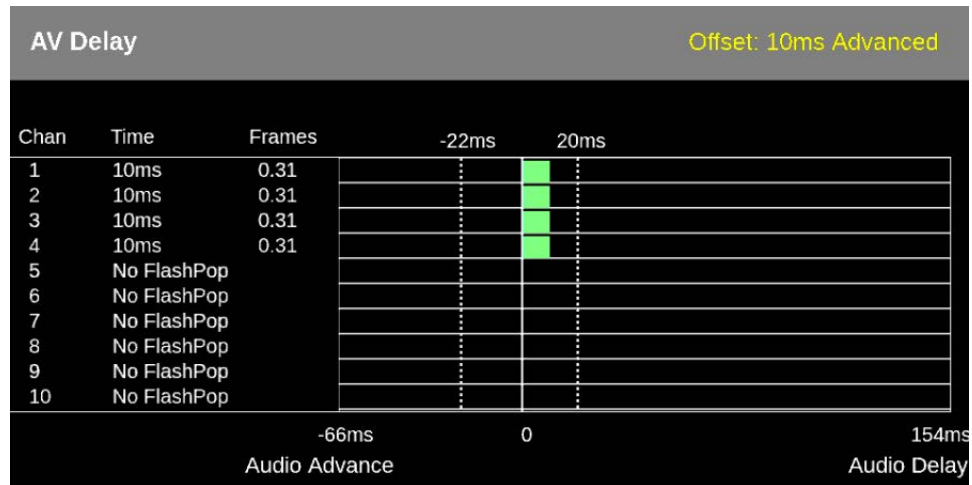

The following example shows an offset of 33 ms Delayed, making the correctly timed visual test signal appear to arrive 33 ms early.

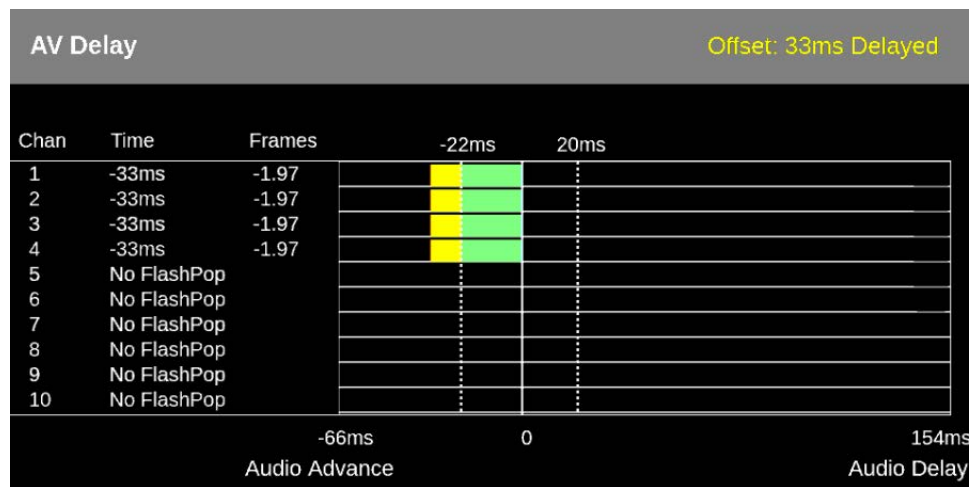

IP Generator and IP Display Applications

The IP Display and IP Generator applications use the 10G/25G IP ports to transmit ST 2110 streams, so they are both included in the same application if the IP Generator option has been purchased. Otherwise, only the standard IP Display application is present.

You can use the IP Display application to send the tiled PRISM display as an ST 2110 stream for multiviewer applications.

Note: IP Display Application is available only on the MPI2/MPX2 series of products.

IP Display					
TRANSPORT		VIDEO			
STREAM	PORT	PAYLD	DEST IP	SOURCE IP	
S2110.20	SFP1	96	239.26.231.68:50020	172.22.231.68:50020	
S2110.20	SFP1	96	239.27.231.68:50020	172.23.231.68:50020	

If you have an IP Generator license, you can check the receiver device and signal path via the IP Generator application, which provides ST 2110 -20/-30 with ST 2022-7 test signals. The application is available only in the 200 and 300 versions of MPS, MPD, and MPP.

Note: The IP Generator application requires Option MP2-GEN.

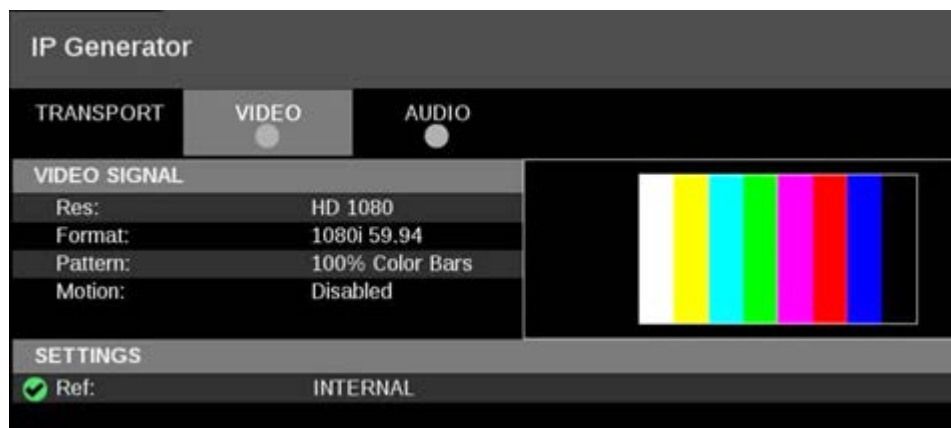

Configure the IP Display Application

1. Select the **Tiles** icon (🧩).
2. Select the tile with the IP Display application.
3. Select the **Tile** icon (⚙️).

Note: To move the settings left or right, select the **Move** icon (↔️) in the Settings menu header.

4. In the **IP Generator Mode** section, select **Display**.
5. Select **IP ST 2110 Display** to enable or disable the IP ST 2110 Display.
6. In the **Reference** section, select the IP Generator reference: **Internal** or **PTP**.

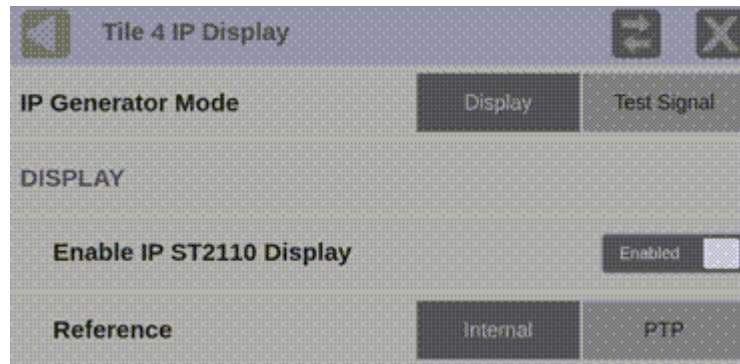

7. The **Resolution** section indicates the resolution.
8. From the **Frame Rate** list, select the frame rate (only the frame rates available for the selected resolution appear):
 - **59.94i**: available for resolution 525i.
 - **50i**: available for resolution 625i.
 - **23.98p, 24p, 25p, 29.97p, 30p, 50p, 50i, 59.94p, 59.94i, 60p, and 60i**: available for resolution 1920x1080.
 - **23.98p, 24p, 25p, 29.97p, 30p, 50p, 59.94p, and 60p**: available for all other resolutions.

Note: The resolution 4096x2160 is limited to a maximum frame rate of 50p if the Video IP Port Data Rate is set to 10Gb.

9. From the **Structure** list, select **YCbCr 4:2:2 10bit** or **RGB 4:4:4 12bit** (for supported Resolution and Frame rates, and for matching receiver, see [Supported Video Formats in ST 2110-20 Streams](#)).
10. In the **RTP Payload Type** box, set the generated IP stream to an RTP Payload Type number between 96 and 127.

Note: Each generated IP stream must have a unique RTP Payload Type number.

VIDEO TRANSPORT SFP 1

Resolution	1920 X 1080
Frame Rate	50p
Structure	YCbCr 4:2:2 10bit
RTP Payload Type	96
Source IP Address	172.20.211.248
Source Port	50020
Source MAC Address	00:90:56:08:28:04

11. Select **DISPLAY 1** and **DISPLAY 2** to enable or disable them as needed. Display 2 is the extended display if you enable that option in the **Settings > Display** menu. Otherwise, it is a mirror of Display 1.
12. For enabled ports, enter addresses into the **Destination Addr.** and **Destination Port** boxes. When enabled and the fields are filled in, each port is configured automatically.

Note: The Source IP Address, Source Port, Source MAC Address, and Destination MAC Address are configured automatically based on the Destination Address and Destination Port.

DISPLAY 1 Enabled

Destination Addr.	239.26.211.248
Destination Port	50020
Destination MAC Address	01:00:5e:1a:d3:f8

13. Select **Save**.

IP Display Elements

Display tabs provide information about the Stream 1 and Stream 2 status for both displays.

View the TRANSPORT Status

Select the **TRANSPORT** tab to view the status of the IP streams.

STREAM	PORT	PAYLD	DEST IP	SOURCE IP
S2110.20	SFP1	96	239.26.231.68:50020	172.22.231.68:50020
S2110.20	SFP1	96	239.27.231.68:50020	172.23.231.68:50020

View Video Stream Settings

Select the **VIDEO** tab to view the settings of the video streams.

VIDEO SIGNAL

Res:	3G LevelA
Format:	1080p 59.94
Structure:	undefined

SETTINGS

Ref:	Internal
Display 1:	Enabled
Display 2:	Enabled

Configure the IP Generator Application

1. Select the **Tiles** icon (🧩).
2. Select the tile with the IP Generator application.
3. Select the **Tile** icon (⚙️).

Note: To move the settings left or right, select the **Move** icon (↔️) in the Settings menu header.

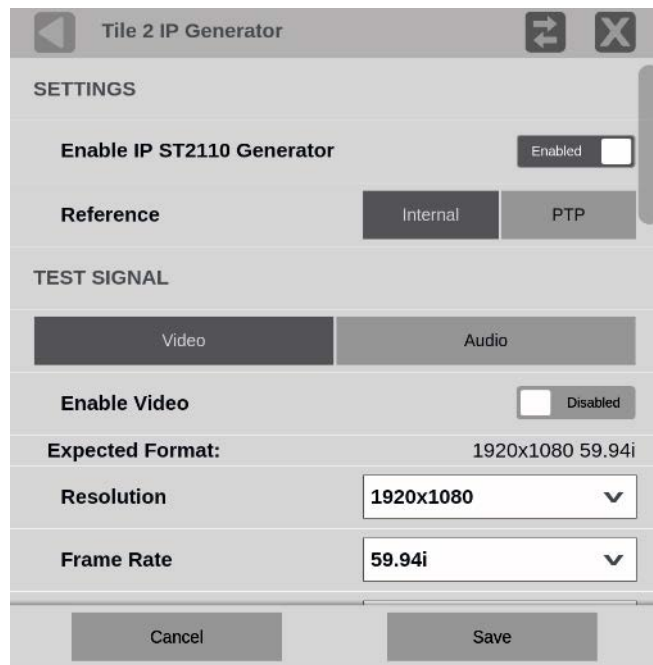

4. In the **IP Generator Mode** section, select **Test Signal**.
5. Select **IP ST 2110 Generator** to enable or disable the IP ST 2110 Generator.
6. In the **Reference** section, select the IP Generator reference: **Internal** or **PTP**.

Configure the Video Test Signal

1. In the **TEST SIGNAL** section, select **Video**.
2. Select **Enable Video** to enable or disable the test signal video.
3. Select **Enable Video** to enable or disable the test signal video.
4. From the **Resolution** list, select **525i**, **625i**, **1280x720**, **1920x1080**, **2048x1080**, **3840x2160**, or **4096x2160**.
5. From the **Frame Rate** list, select the frame rate (only the frame rates available for the selected resolution appear):
 - **59.94i**: available for resolution 525i.
 - **50i**: available for resolution 625i.
 - **23.98p**, **24p**, **25p**, **29.97p**, **30p**, **50p**, **50i**, **59.94p**, **59.94i**, **60p**, and **60i**: available for resolution 1920x1080.
 - **23.98p**, **24p**, **25p**, **29.97p**, **30p**, **50p**, **59.94p**, and **60p**: available for all other resolutions.

Note: The resolution 4096x2160 is limited to a maximum frame rate of 50p if the Video IP Port Data Rate is set to 10Gb.

6. From the **Structure** list, select **YCbCr 4:2:2 10bit** or **RGB 4:4:4 12bit** (for supported Resolution and Frame rates, and for matching receiver, see [Supported Video Formats in ST 2110-20 Streams](#)).
7. From the **Pattern** list, select **Black** or **100% Color Bars**.
8. Select **Motion** to enable or disable horizontal motion of the color bars.

Note: The resolution 4096x2160 is limited to a maximum frame rate of 50p if the Video IP Port Data Rate is set to 10Gb.

9. From the **Structure** list, select **YCbCr 4:2:2 10bit** or **RGB 4:4:4 12bit** (for supported Resolution and Frame rates, and for matching receiver, see [Supported Video Formats in ST 2022-6 Streams](#)).
10. From the **Pattern** list, select **Black** or **100% Color Bars**.
11. Select **Motion** to enable or disable horizontal motion of the color bars.

Note: The Motion option is unavailable when Pattern is set to Black.

Packing Mode

Select a packing mode:

- **Block:** Block Packing Mode is based on 180-byte blocks and supports many formats.
- **General:** General Packing Mode follows the open packing standards of RFC 4175.

RTP Payload Type

In the **RTP Payload Type** box, set the generated IP stream to an RTP Payload Type number between 96 and 127.

Note: Each generated IP stream must have a unique RTP Payload Type number.

Packet Read Schedule (PRS)

Select a read schedule:

- **Gapped:** Gapped PRS reads packets at an equally spaced sequence throughout the active field or frame interval and accounts for vertical blanking (gaps).
- **Narrow (Linear):** Narrow (linear) PRS reads the packets at an equally spaced sequence throughout a video frame.

VIDEO PORT SFP+ 1 and SFP+ 2

1. Set **VIDEO PORT SFP 1** and **VIDEO PORT SFP 2** to **Enabled** or **Disabled** as needed.
2. For enabled ports, enter addresses in the **Destination Addr.** and **Destination Port** boxes. When enabled and the fields are filled in, each port is configured automatically.

Note: The Source IP Address, Source Port, Source MAC Address, and Destination MAC Address are automatically configured based on the Destination Address and Destination Port.

VIDEO PORT SFP 1		Enabled <input type="checkbox"/>
Source IP Address	172.22.198.67	
Source Port	<input type="text" value="50020"/>	
Source MAC Address	00:90:56:08:2b:a7	
Destination Addr.	<input type="text" value="239.26.198.138"/>	
Destination Port	<input type="text" value="50020"/>	
Destination MAC Address	01:00:5e:1a:c6:8a	

Configure the Audio Test Signal

1. In the **TEST SIGNAL** section, select **Audio**.
2. Select **Enable Audio** to enable or disable it.

TEST SIGNAL	
Video	Audio
Enable Audio	Enabled <input checked="" type="checkbox"/>
Channels	2 8
Frequency	1kHz Multiple
Amplitude	Mute -20 dBFS -18 dBFS
Sample Depth (all Channels)	24 bit

3. In the **Channels** section, select **2** or **8** channels.
4. In the **Frequency** section, select **1-kHz** or **Multiple**.
5. In the **Amplitude** section, select an option:
 - **Mute**: always available
 - **-20 dBFS**: available when Frequency is set to 1 kHz
 - **-18 dBFS**: available when Frequency is set to 1 kHz

- **Multiple:** available when Frequency is set to Multiple

6. The Sample Depth (all Channels) section lists the sample depth of all channels. The following table shows the audio test signal values in each channel when both Frequency and Amplitude, in the Settings menu, are set to Multiple.

Multiple Settings with Amplitude and Frequency Levels Per Channel

Channel	Amplitude (dBFS)	Frequency (Hz)
1	-18	240
2	-22	480
3	-20	360
4	-28	120
5	-24	600
6	-26	1200
7	-30	1800
8	-32	2400

7. In the **Packet Time** section, select **125 µs** or **1 ms**.

8. In the **RTP Payload Type** box, type an RTP Payload Type number for the generated IP stream.

Note: Each generated IP stream must have a unique RTP Payload Type number.

9. Select **AUDIO PORT SFP 1** and **AUDIO PORT SFP 2** to enable or disable them as needed.

10. For enabled ports, enter addresses into the **Destination Addr.** and **Destination Port** fields. When enabled and the fields are filled in, each port is configured automatically.

Note: The Source IP Address, Source Port, Source MAC Address, and Destination MAC Address are configured automatically based on the Destination Address and Destination Port.

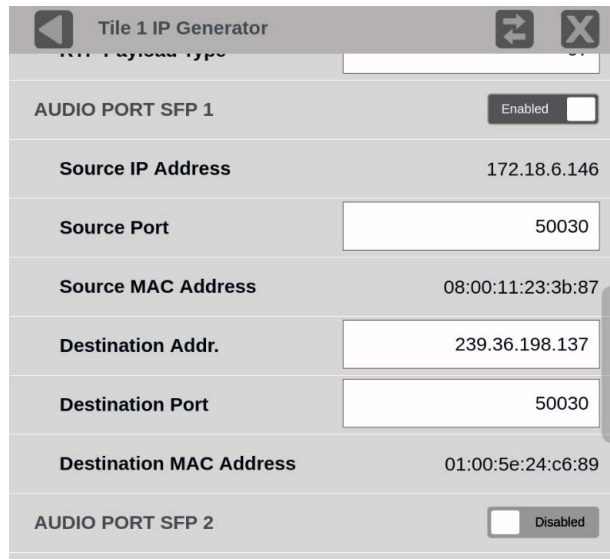

11. Select **Save**.

IP Generator Elements

Display tabs provide information regarding the generated IP streams. Select a tab to view the associated display.

TRANSPORT Tab

Select the **TRANSPORT** tab to view the status of the generated IP streams.

IP Generator						
TRANSPORT		VIDEO	AUDIO			
STREAM	PORT	PAYLD	DEST IP	SOURCE IP		D
● S2110.20 P1	SFP1	96	239.20.54.17:50020	172.21.54.17:50020		0
● S2110.20 P2	SFP2	96	239.20.54.17:50020	172.22.54.17:50020		0
● S2110.30 P1	SFP1	97	239.30.54.17:50030	172.21.54.17:50030		0
● S2110.30 P2	SFP2	97	239.30.54.17:50030	172.22.54.17:50030		0

VIDEO Tab

Select the **VIDEO** tab to view the settings of the generated video stream.

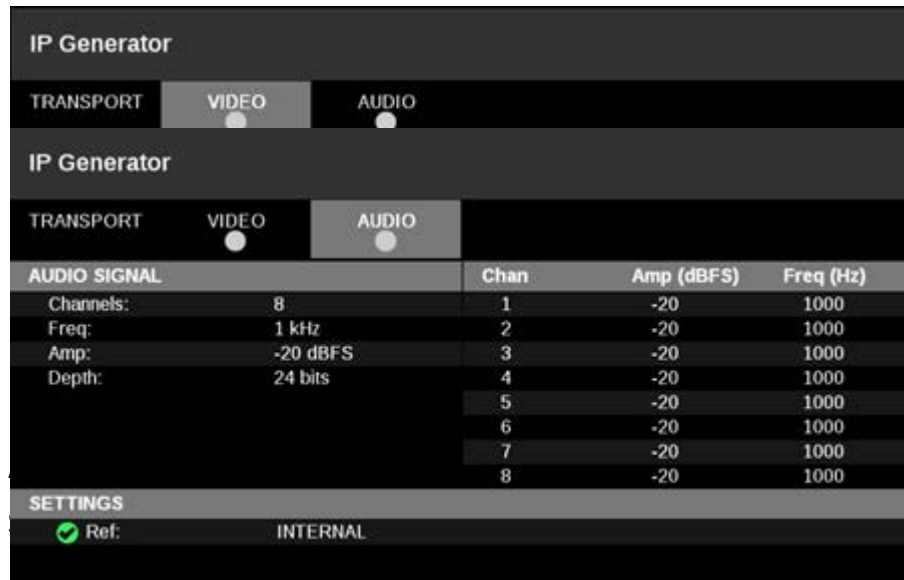

SDI Generator Application

The SDI Generator application provides SDI video signals that can be used to check the receiver device and the signal path.

Note: The SDI Generator application requires Option MP2-GEN.

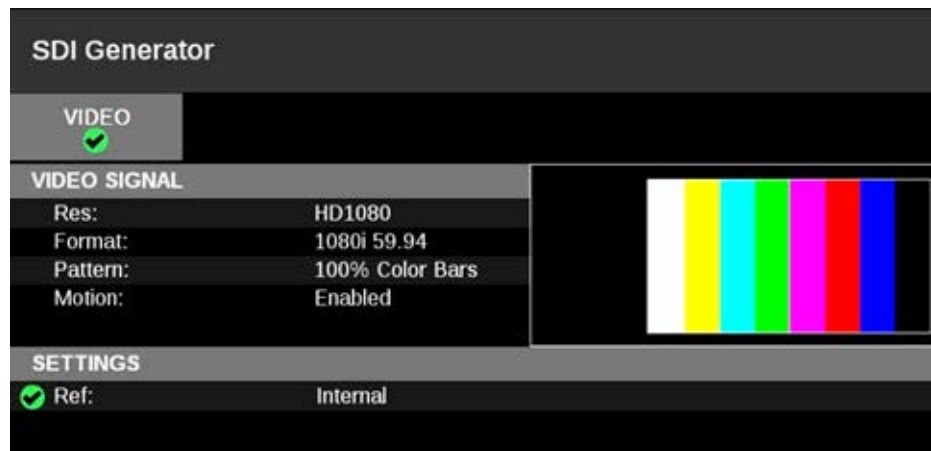

Configure the SDI Generator Application

1. Select the Tiles icon ().
2. Select the tile with the SDI Generator application.

3. Select the **Tile** icon ().

Note: To move the settings left or right, select the **Move** icon () in the Settings Menu header.



SETTINGS	
Enable SDI Generator <small>Generator is not selected in Settings > Output menu</small>	Enabled <input checked="" type="checkbox"/>
Reference	Internal
TEST SIGNAL	
Format	12G UHD ▼
Frame Rate	3840x2160p 59.94 ▼
Pattern	100% Color Bars
Motion	<input type="checkbox"/> Disabled

4. Set **Enable SDI Generator** to **Enabled** or **Disabled**.

5. The Reference section indicates that the SDI Generator uses an internal reference.

6. From the **Format** list, select the format: **SD, HD 720, HD1080, 3G LevelA, 3G LevelB, 6G UHD, or 12G UHD**.

7. In the **Frame Rate** list, select the frame rate (only the frame rates available for the selected format appear):

- **525i 59.94:** for format SD only
- **625i 50:** for format SD only
- **720p 50:** for format HD 720 only
- **720p 59.94:** for format HD 720 only
- **720p 60:** for format HD 720 only
- **1080i 50:** for format HD 1080 only
- **1080p 50:** for format 3G LevelA or 3G LevelB only
- **1080i 59.94:** for format HD 1080 only
- **1080p 59.94:** for format 3G LevelA or 3G LevelB only
- **1080i 60:** for format HD 1080 only
- **1080p 60:** for format 3G LevelA or 3G LevelB only
- **3840p 23.98:** for format 6G UHD only
- **3840p 24:** for format 6G UHD only

- **3840p 25:** for format 6G UHD only
 - **3840p 29.97:** for format 6G UHD only
 - **3840p 30:** for format 6G UHD only
 - **3840p 50:** for format 12G UHD only
 - **3840p 59.94:** for format 12G UHD only
 - **3840p 60:** for format 12G UHD only
- 8.** The Pattern section lists the only pattern, 100% Color Bars.
- 9.** Select **Motion** to enable or disable horizontal motion of the color bars.

SDI Generator Elements

Select the **VIDEO** tab to view the settings of the generated SDI stream.

Note: SDI audio and data generation is not yet available.

PTP Operational Overview

This chapter provides an overview of PTP network operation. Not all of the functionality described is available in the PRISM monitor.

PTP Introduction

This describes how a PTP leader is chosen, with some description of the priorities. It also explains some of the relationship between the potential devices.

PTP Leader Selection

In a PTP network, all the leaders on the network are evaluated by the Best Master Clock Algorithm (BMCA). The BMCA runs on all devices, and chooses a leader based on several parameters. Some of the parameters relate to clock quality; conversely the Priority 1 and Priority 2 parameters are set by the user to influence the choice of a leader:

Note: The PRISM monitor has no role in setting the priority parameters or in providing information to the BMCA.

- Priority 1: This parameter defines which clocks are allowed to be considered as leaders. To be considered as a leader, the value should be set to 128 or less. Priority 1 is the first criteria in the BMCA, so if Priority 1 is set to a lower value than other devices on the system, then it is chosen even if the clock quality is poor. Typically, all the leaders in a domain should have the same value for the Priority 1 parameter.
- Priority 2: This parameter is used to break the tie between leaders that have the same clock quality. Several values can be used to define a hierarchy of devices. Most profiles use 128 as a default, so a value of 127 or lower would indicate a preferred leader.
- The final tiebreaker in the BMCA is the clock ID. This is usually the MAC address, so it provides a unique value by which the BMCA can choose.

Network Topology

In a typical IEEE1588 PTP network, many devices can be either leaders or followers. If the current leader stops working, all the devices that are capable of being a leader broadcast their clock quality and a new leader is selected.

For video networks it might make sense to depart from the telecom-style PTP topology and dedicate devices to be only leaders or followers. This is the approach supported by the PRISM monitor, which allows for a more traditional primary and backup leader structure controlling a range of follower devices. The BMCA is still used to select the active leader and the network still takes the place of the ECO in the legacy Black-burst/Tri-level network. The PRISM monitor is a follower-only device.

Five Basic PTP Timing Messages

This section describes the five basic timing messages in a PTP system. Other messages are present in some instances. For example, grant requests and responses appear in unicast systems, and Type Length Value (TLV) management messages appear in ST 2059 profile systems.

Announce Message

The Announce message is sent by the leader to advertise its capability. This message contains the clock quality and priority settings needed for the BMCA to evaluate which device is the best leader.

Sync Message

The Sync message is sent by the leader and is used to measure the propagation delay from the leader to the follower. The sync message might contain the timestamp indicating when it was sent, or that time might be in the Follow-up message. The receiver must timestamp the sync message upon receipt. These two timestamps are usually called t1 and t2 and provide the first delay measurement.

Follow-up Message

The Follow-up message is sent only in cases where the PTP network hardware is not capable of inserting the timestamp or corrections into the Sync message. (See [One-Step and Two-Step Operation](#).)

Delay Request Message

The Delay request is sent by the follower. The time it is sent is noted by the follower but is not included in the message. This time is usually called t3. When the delay request is received by the leader, the leader timestamps the receive time. This timestamp is usually called t4.

Delay Response Message

The Delay response is sent from the leader to the follower. The response contains the t4 timestamp from when the leader received the delay request. After the follower receives

the delay response, it has the second pair of timestamps needed to calculate the second delay measurement of the follower to leader delay.

Message Timing

The example shows the relationships between the five PTP timing messages.

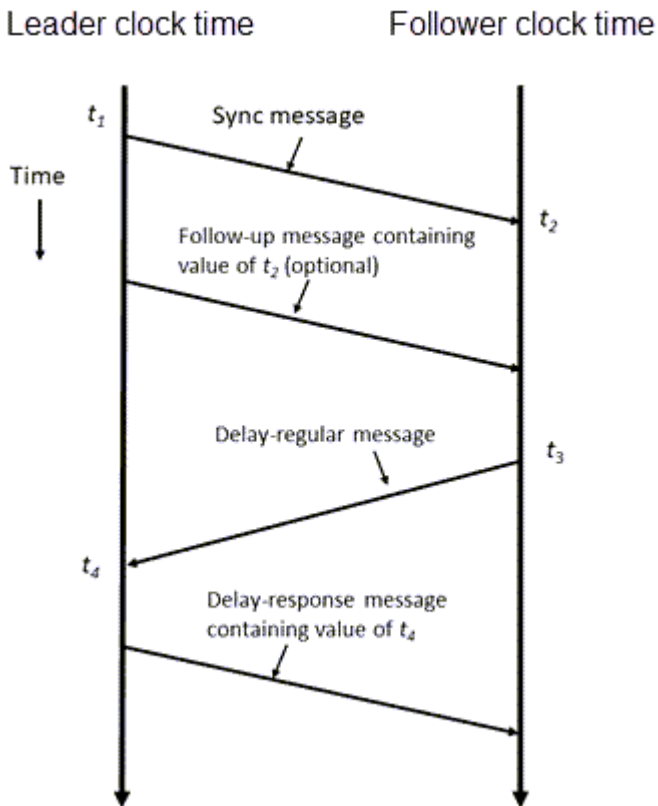

Profiles and Domains

Multiple domains and profiles can coexist on the same network.

Profiles

The IEEE1588 standard defines multiple parameters, such as the rates for Sync and Announce messages, and optional functions such as grandmaster clusters. Specific industries wanting to use PTP are encouraged to define their own "profile," which allows the PTP standard to be tuned for specific applications. The profile defines the default and range of each parameter, and defines which options are required, allowed, or prohibited.

In the PRISM monitor, the user should select the PTP profile (General, ST 2059, or AES67). The user can then modify the profile parameters and save as part of an

instrument preset. The allowed range of the parameters is restricted to that which is allowed for the selected profile type.

Domains

The IEEE1588 standard defines “domains,” which allow multiple PTP services to coexist simultaneously on one physical Ethernet connection. For example, on a given network one leader and several followers can be using domain 0 while a second leader and other followers are using domain 1. These two PTP services are independent. One use for this is to have leaders on different domains provide PTP on different profiles. For example, domain 0 might be an AES67 profile, domain 1 could be a leader using the AVB (802.1AS) profile, and domain 127 could be a leader on the ST 2059 profile.

One-Step and Two-Step Operation

Some PTP messages have a timestamp associated with them. This timestamp indicates the time of the local clock when the message was sent or received. In some cases, the hardware is capable of embedding the timestamp in the message as it is sent. This is known as “one-step” mode because the message and its associated time are sent together.

In other cases, the hardware is not capable of inserting the time into the message, so instead it is sent in a second Follow-up message. This is called “two-step” mode because there are two messages.

Be aware that in End-to-End mode, only the Sync message is affected by the one-step and two-step setting because it is the only message that needs the transmit time stamp inserted. In a similar fashion, Peer-to-Peer mode has some messages that might require follow-up support.

The IEEE1588 standard specifies that all followers are required to operate with either one-step or two-step message types. One type of device that often requires two-step operation is a Transparent Clock, because it has to calculate the residence time of a message and insert that time into the message or the follow-up message.

Multicast, Unicast, and Mixed Communication Modes

There are three basic message modes for PTP: Multicast, Unicast, and mixed Multicast and Unicast. For full Multicast or Unicast modes, all of the PTP messages are sent in the selected mode type.

For some profiles, such as some telecom profiles and the ST2059 profile, a mixture of Multicast and Unicast are allowed. On the SMPTE profile unique mixed mode, the Announce and Sync messages are sent as multicast. However, the Delay Request and Delay Response messages are sent as Unicast.

Some points to understand about communication modes:

- Whatever mode is chosen, the leader and follower must match or be compatible.
- Multicast and Mixed mode might need IGMP joins and leaves.
- Full Unicast must have the leader address in all follower AMTs.
- Unicast without negotiation does not allow leader to regulate load.
- Two leaders can be used on different domains to serve followers on different communication modes.

All of the leader and follower devices on a given domain must use compatible communication modes. For most profiles, this means the leader and follower communication modes need to match exactly. On the SMPTE profile, the Multicast and Mixed modes are compatible, so a leader in any of these modes should work with a follower in any of those modes.

Multicast System Messages

Multicast messages are broadcast and so they can be received without knowing the address of the sender. This allows a follower to hook up to the network, receive the announce messages and discover the identity of the leader. Multicast in some networks requires the devices to use IGMP to join and leave the multicast group.

In Multicast PTP systems, the leader sets the rate of the announce and sync messages. The leader also sends the maximum allowed delay request rate in the delay response message. Ideally, the follower uses that value to set the delay request rate although some followers set this rate independently. The delay request rate is typically the same as the sync rate, but might be higher or lower.

Unicast System Messages

Unicast messages require the address of the leader be entered into the Acceptable Master Table (AMT) in each follower. If there are multiple leaders, the IP address for each leader must be entered in the AMTs of all the followers.

In Unicast PTP systems, the follower must have the address of the leader in its acceptable leader table because the follower initiates the communication with the leader. The follower sends several grant requests to the leader requesting specific rates for each message type. If the leader accepts the grant requests, it sends grant acknowledges. If the leader denies the grant, the follower might send a new grant request at a lower rate. This process might continue for several iterations until the leader and follower agree on a rate. The leader and follower then start exchanging the PTP messages. If the leader cannot support any of the rates requested by the follower, then the follower cannot lock to the leader.

Mixed Mode System Messages

In Mixed Mode systems, some messages are Multicast and some are Unicast. For the ST 2059 profile, the Announce and Sync messages are sent as Multicast. This allows

devices to discover the active leader. The Delay Request messages are configured as Unicast, in some case with negotiation, and in other cases without negotiation.

SMPTE Profile System Messages

For SMPTE profile systems, a given domain must use one type of message for all Announce, Sync, and Follow-up messages. Therefore, all leaders and followers on that domain must be configured for either Multicast or they all must be configured for Unicast.

For SMPTE mixed mode, the Announce, Sync, and Follow up messages are configured as Multicast, whereas the delay requests can be Multicast, Unicast, or Unicast without negotiation. To use this combination with an SPG8000A or SPG9000 reference clock generator, set the leader and follower to any of the modes: Multicast, Mixed, or Mixed without negotiation. The leaders support all of the follower modes simultaneously.

BMCA Operation

The Best Master Clock Algorithm (BMCA) is used to choose the active leader on the domain. This is partially explained in the introduction to this document. The BMCA operation varies somewhat as function of communication mode.

Multicast Mode

In Multicast mode, the active leader sends announce messages which all other leaders and followers can receive. So all devices can evaluate the BMCA and decide on the best leader. If any device detects that its BMCA rating is better than the current leader, it sends an announcement and takes over as the active leader.

Unicast Mode

In Unicast mode, followers only get Announce messages if they establish a grant from the leader. Therefore, each follower must set up a grant with every device in its AMT. Since the leaders do not set up grants from other leaders, they do not have the information to evaluate the BMCA and know if they are the active leader. It is up to the followers to evaluate the BMCA based on the Announce message they get from each leader in their AMT. Each follower then decides which leader is the best and then set up grants for the other message types. If followers on a given network have a different list of leaders in their AMT, then they might choose a different leader.

Mixed Mode

In a ST 2059 mixed environment, the announce message is Multicast. Therefore, the BMCA can follow the Multicast conventions.

Compensating for Causes of Asymmetric Delay

Several factors can cause the PTP message delay to be different for the messages sent from the leader to follower as opposed to the messages the other direction from the follower to leader. Unless corrected, this propagation delay asymmetry causes an offset in the clock phase equal to $\frac{1}{2}$ the difference in the two path delays. There are several main causes of asymmetric delay:

- Rate mismatch in the ports on a switch
- Traffic mismatch on the two paths
- Message type mismatch
- Cable delay variation

This section contains suggestions on how to design the system to minimize the delay asymmetry. Alternatively, some followers provide a way to manually enter a correction value to cancel the delay error.

Rate Mismatch

Rate mismatch in a switch causes a delay asymmetry because the switch performs a “store and forward” action on messages. This means the entire message must be stored in the buffer before it starts to be “forwarded” or sent out. For example, for a 100 Mb input and 1 Gb output, the switch must wait for the entire message to clock in at the slow rate before it can start outputting the message at the high rate. Conversely for a 1 Gbps input and 100 Mbps output, the entire packet is quickly read in at the faster rate, so then the output can start sooner but at a lower rate.

While the total time is the same for both directions, the delay on the fast-in, slow-out direction is shorter on the packets, which contain the PTP time stamps. This effect is significant on a 100-Mb to 1-Gb rate mismatch, but much less significant on a 1-G to 10-G switch since the message time at 1 Gbps is quite short. If the switch supports Transparent Clock (TC) mode, then this rate mismatch delay effect is corrected by the TC delay correction.

Traffic Mismatch

Another cause of asymmetric delay is traffic mismatch on the two paths. If there is a high percentage of traffic utilization on the leader to follower path, then most of the PTP messages might be delayed significantly. If the traffic on the other direction is significantly different, then the messages on the path might not suffer the same delay.

This effect can be quite large depending on the traffic, the quality of the switch, and the number of switches in the network. To reduce this effect, a user should avoid large loading on the PTP network, use high-quality switches that avoid this delay variance, or use PTP Transparent mode switches that insert residence time information to allow the follower to correct for this delay.

Setting the Diff Serve QoS on the switch and configuring the PTP messages with an appropriate DSCP can also mitigate the effects of traffic delay.

Message Type Mismatch

Another cause of delay asymmetry is message-type mismatch. For example, if the sync message is Multicast and the delay request is Unicast, then some switches might process the messages differently and cause a differential delay. Because the SMPTE profile allows a mixed mode operation, switches should be evaluated to ensure they do not have this effect. If transparent mode switches are used, then this effect should be corrected by the follower.

Cable Delay Variation

The actual propagation delay through Category 5 cable can be significantly different in one direction versus the other direction. This can be due to the twist rate on the pairs, routing inside the sheath, material differences, etc. The PTP system is incapable of removing this effect, so the best way to prevent this is to use high-quality cable with a minimum variation in the physical propagation delay.

NMOS Specifications

This chapter summarizes key NMOS specifications. Some of the specifications might not be available in the PRISM monitor.

NMOS Discovery Version 1.3

The changes in NMOS Discovery version 1.3 are summarized here.

- Added additional network data for nodes as required by IS-06.
- Deprecated mDNS announcements for nodes in registered mode.
- Replaced DNS-SD service type for registration API.
- Permit deprecated node API connection management is not implemented.
- Added explicit requirements for 501 responses when features are not implemented.
- Added support for future device and transport types.
- Permitted a sender's "manifest_href" to be null when the transport type does not require a transport file.
- Added 409 response code for registries with conflicting resources.
- Added support for signaling authorization requirements.
- Indicated the potential for source/flow attributes and caps will be defined externally in the future.
- Revised the discovery process to ignore mDNS records when unicast records are available.