



**SPG9000
User Manual**

Copyrights and Trademark Notices

Copyright © 2025 Telestream, LLC and its Affiliates. All rights reserved. TELESTREAM is a registered trademark of Telestream, LLC. All other trade names referenced are the service marks, trademarks, or registered trademarks of their respective companies.

Telestream products are covered by U.S. and foreign patents, issued and pending. Information in this publication supersedes that in all previously published material. Specifications and price change privileges reserved.

TELESTREAM is a registered trademark of Telestream, LLC.

Warranty

Telestream on behalf of itself and its Affiliates (“Telestream”) warrants that this product will be free from defects in materials and workmanship for a period of one (1) year from the date of shipment. If any such product proves defective during this warranty period, Telestream, at its option, either will repair the defective product without charge for parts and labor, or will provide a replacement in exchange for the defective product. Parts, modules and replacement products used by Telestream for warranty work may be new or reconditioned to like new performance. All replaced parts, modules and products become the property of Telestream.

In order to obtain service under this warranty, Customer must notify Telestream of the defect before the expiration of the warranty period and make suitable arrangements for the performance of service. Customer shall be responsible for packaging and shipping the defective product to the service center designated by Telestream, with shipping charges prepaid. Telestream shall pay for the return of the product to Customer if the shipment is to a location within the country in which the Telestream service center is located. Customer shall be responsible for paying all shipping charges, duties, taxes, and any other charges for products returned to any other locations.

This warranty shall not apply to any defect, failure or damage caused by improper use or improper or inadequate maintenance and care. Telestream shall not be obligated to furnish service under this warranty a) to repair damage resulting from attempts by personnel other than Telestream representatives to install, repair or service the product; b) to repair damage resulting from improper use or connection to incompatible equipment; c) to repair any damage or malfunction caused by the use of non- Telestream supplies; or d) to service a product that has been modified or integrated with other products when the effect of such modification or integration increases the time or difficulty of servicing the product.

THIS WARRANTY IS GIVEN BY TELESTREAM WITH RESPECT TO THE PRODUCT IN LIEU OF ANY OTHER WARRANTIES, EXPRESS OR IMPLIED. TELESTREAM AND ITS VENDORS DISCLAIM ANY IMPLIED WARRANTIES OF MERCHANTABILITY OR FITNESS FOR A PARTICULAR PURPOSE. TELESTREAM’S RESPONSIBILITY TO REPAIR OR REPLACE DEFECTIVE PRODUCTS IS THE SOLE AND EXCLUSIVE REMEDY PROVIDED TO THE CUSTOMER FOR BREACH OF THIS WARRANTY. TELESTREAM AND ITS VENDORS WILL NOT BE LIABLE FOR ANY INDIRECT, SPECIAL, INCIDENTAL, OR CONSEQUENTIAL

DAMAGES IRRESPECTIVE OF WHETHER TELESTREAM OR THE VENDOR HAS ADVANCE NOTICE OF THE POSSIBILITY OF SUCH DAMAGES.

[W2 – 15AUG04]

TELESTREAM SOFTWARE LICENSE AGREEMENT

THE PROGRAM, OR PROGRAMS, ENCODED OR INCORPORATED WITHIN EQUIPMENT OR ACCOMPANYING THIS AGREEMENT, IS FURNISHED SUBJECT TO THE TERMS AND CONDITIONS OF THIS AGREEMENT. RETENTION OF THE PROGRAM FOR MORE THAN THIRTY DAYS OR USE OF THE PROGRAM IN ANY MANNER WILL BE CONSIDERED ACCEPTANCE OF THE AGREEMENT TERMS. IF THESE TERMS ARE NOT ACCEPTABLE, THE UNUSED PROGRAM AND ANY ACCOMPANYING DOCUMENTATION SHOULD BE RETURNED PROMPTLY TO TELESTREAM FOR A FULL REFUND OF THE LICENSE FEE PAID. (FOR INFORMATION REGARDING THE RETURN OF PROGRAMS ENCODED OR INCORPORATED WITHIN EQUIPMENT, CONTACT THE NEAREST TELESTREAM SALES OFFICE.)

DEFINITIONS

“Telestream” means Telestream, LLC, a Delaware limited liability company, and its Affiliates, or the local Telestream legal entity that is supplying the equipment.

“Program” means the Telestream software product (executable program and/or data) enclosed with this Agreement or included within the equipment with which this Agreement is packed. “Customer” means the person or organization in whose name the Program was ordered.

LICENSE

Customer may:

1. Use the Program on a single machine at any one time; and
2. Copy the Program for archival or backup purposes, provided that no more than one (1) such copy is permitted to exist at any one time. Each copy of the Program made by Customer must include a reproduction of any copyright notice or restrictive rights legend appearing in or on the copy of the Program as received from Telestream.

Customer may not:

1. Use the Program on more than one machine at any one time;
2. Transfer the Program to any person or organization outside of Customer or the corporation of which Customer is a part without the prior written consent of Telestream, except in connection with the transfer of the equipment within which the programs are encoded or incorporated;
3. Export or re-export, directly or indirectly, the program, any associated documentation, or the direct product thereof, to any country to which such export or re-export is restricted by law or regulation of the United States or any foreign government having jurisdiction without the prior authorization, if required, of the Office of Export Administration, Department of Commerce, Washington, D.C. and the corresponding agency of such foreign government;

4. Modify the Program, create derivative works, or merge the Program with another program;
5. Reverse compile or disassemble the Program for any purpose, beyond the extent that such activity is expressly permitted by applicable open source licenses or applicable law notwithstanding this limitation; or
6. Copy the documentation accompanying the Program.

For Programs designed to reside on a single-machine and support one or more additional machines, either locally or remotely, without permitting the Program to be transferred to an additional machine for local execution, the additional machines shall be considered within the definition of "single machine." For programs permitting the Program to be transferred to an additional machine for local execution, a separate license shall be required for each such machine with which the Program may be used. Title to the Program and all copies thereof, but not the media on which the Program or copies may reside, shall be and remain with Telestream or others for whom Telestream has obtained a respective licensing right. Customer shall pay when due all property taxes that may now or hereafter be imposed, levied or assessed with respect to the possession or use of the Program or this license and shall file all reports required in connection with such taxes. If the Program or any related documentation is acquired by or for an agency of the U.S. Government, the Program and documentation shall be considered "commercial computer software" or "commercial computer software documentation" respectively, as those terms are used in 48 CFR §12.212, 48 CFR §227.7202, or 48 CFR §252.227-7014, and are licensed with only those rights as are granted to all other licensees as set forth in this Agreement.

THE PROGRAM MAY NOT BE USED, COPIED, MODIFIED, MERGED, OR TRANSFERRED TO ANOTHER EXCEPT AS EXPRESSLY PERMITTED BY THESE TERMS AND CONDITIONS. UPON TRANSFER OF ANY COPY, MODIFICATION, OR MERGED PORTION OF THE PROGRAM, THE LICENSE GRANTED HEREIN IS AUTOMATICALLY TERMINATED WITH RESPECT TO THE PARTY THAT TRANSFERS THE PROGRAM.

TERM

The license granted herein is effective upon acceptance by Customer, and shall remain in effect until terminated as provided herein. The license may be terminated by Customer at any time upon written notice to Telestream. The license may be terminated by Telestream or any third party from whom Telestream may have obtained a respective licensing right if Customer fails to comply with any term or condition and such failure is not remedied within thirty (30) days after notice hereof from Telestream or such third party. Upon termination by either party, Customer shall return to Telestream or destroy, the Program and all associated documentation, together with all copies in any form.

LIMITED WARRANTY

The Program is provided "as is" without warranty of any kind, either express or implied. Telestream does not warrant that the functions contained in the Program will meet Customer's requirements or that the operation of the Program will be uninterrupted or error-free.

TELESTREAM AND ITS VENDORS DISCLAIM ANY IMPLIED WARRANTIES OF MERCHANTABILITY OR FITNESS FOR A PARTICULAR PURPOSE. LIMITATION OF LIABILITY, IN NO EVENT SHALL TELESTREAM OR OTHERS FROM WHOM TELESTREAM HAS OBTAINED A LICENSING RIGHT BE LIABLE FOR ANY INDIRECT, SPECIAL, INCIDENTAL, OR CONSEQUENTIAL DAMAGES ARISING OUT OF OR CONNECTED WITH CUSTOMER'S POSSESSION OR USE OF THE PROGRAM, EVEN IF TELESTREAM OR SUCH OTHERS HAS ADVANCE NOTICE OF THE POSSIBILITY OF SUCH DAMAGES.

THIRD-PARTY DISCLAIMER

Except as expressly agreed otherwise, third parties from whom Telestream may have obtained a licensing right do not warrant the program, do not assume any liability with respect to its use, and do not undertake to furnish any support or information relating thereto.

GENERAL

This Agreement contains the entire agreement between the parties with respect to the use, reproduction, and transfer of the Program. Neither this Agreement nor the license granted herein is assignable or transferable by Customer without the prior written consent of Telestream. This Agreement and the license granted herein shall be governed by the laws of the state of California. All questions regarding this Agreement or the license granted herein should be directed to the nearest Telestream Sales Office.

THIRD-PARTY SOFTWARE LICENSE

The SPG9000 PTP option uses open source software from the Linux PTP Project (ptp4l), which is licensed under GPL v2.0. The ptp4l source code has been modified for use on the SPG9000, so a copy of the modified source code will be made available upon request in accordance with the GPL v2.0 license. Visit www.telestream.net/telestream-support/video/support.htm to find contacts in your area.

Contents

Important Compliance and Safety Information	8
Preface	19
Product Description	21
Base Capabilities	21
Optional Capabilities	22
Instrument Installation	24
Rackmount Installation	24
Power Connection	32
Rear Panel Connectors	33
SFP Module Installation	38
GNSS Antenna Installation	39
System Operation	42
Front-Panel Interface	42
Management Network Interface	48
Web User Interface	52
Application Programming Interfaces	59
General Purpose Interface	71
Presets	74
File Management	78
Network Packet Capture	80
Fonts	81
System Status and Monitoring	83
Indicators	83
Status Information	88
Reference and Time Sources	110
Theory of Operation	110
Reference and Time Sources	115
Network Time Protocol	122
Genlock Reference	125
GNSS Receiver Settings	128

Daily Jam Sync	132
Daylight Saving Time Management	133
Leap Second Management	136
Program Time Counter	139
PTP Operation	141
Theory of Operation	141
PTP Configuration	152
Synchronization Outputs	165
Black Outputs	165
Linear Time Code Input and Outputs	172
Audio Reference Outputs	175
Test Signal Generation	177
Video Sources	177
Audio Sources	203
SDI Outputs	205
IP Streams	211
System Maintenance	229
Power Supply Monitoring and Replacement	229
Licensed Features	235
Upgrade Instrument Firmware	238
Service Report	243
System Oscillator Calibration	244
Security Considerations	245

Important Compliance and Safety Information

United States of America Compliance Notices

Class A Interference Statement

This equipment has been tested and found to comply with the limits for a Class A digital device, pursuant to Part 15, Subpart B of the FCC Rules. These limits are designed to provide reasonable protection against harmful interference in a commercial installation. This equipment generates, uses, and can radiate radio frequency energy and, if not installed and used in accordance with the instructions, may cause harmful interference to radio communications. However, there is no guarantee that interference will not occur in a particular installation. Operation of this equipment in a residential area is likely to cause harmful interference in which case the user will be required to correct the interference at his own expense.

FCC Caution

This device complies with Part 15 of the FCC Rules. Operation is subject to the following two conditions:

1. This device may not cause harmful interference, and
2. This device must accept any interference received, including interference that may cause unexpected operation.

Safety

UL 61010-1: 2012 R7.19: Safety Requirements for Electrical Equipment for Measurement, Control, and Laboratory Use - Part 1: General Requirements.

Environmental

Perchlorate Materials: this product contains one or more type CR lithium batteries. According to the state of California, CR lithium batteries are classified as perchlorate materials and require special handling.

See www.dtsc.ca.gov/hazardouswaste/perchlorate for additional information.

Canada Compliance Notices

Department of Communications Radio Interference Regulations

This digital apparatus does not exceed the Class A limits for radio-noise emissions from a digital apparatus as set out in the Radio Interference Regulations of the Canadian Department of Communications. This Class A digital apparatus complies with Canadian ICES-003.

Règlement sur le brouillage radioélectrique du Quadstere des Communications

Cet appareil numérique respecte les limites de bruits radioélectriques visant les appareils numériques de classe A prescrites dans le Règlement sur le brouillage radioélectrique du Quadstere des Communications du Canada. Cet appareil numérique de la Classe A est conforme à la norme NMB-003 du Canada.

Safety

CAN/CSA-C22.2 NO. 61010-1-12 + G11 + G12 (R2017) + A1: Safety Requirements for Electrical Equipment for Measurement, Control, and Laboratory Use - Part 1: General Requirements.

Sécurité

CAN/CSA-C22.2 NO. 61010-1-12 + G11 + G12 (R2017) + A1: Exigences de sécurité pour l'électricité Matériel de mesure, de contrôle et d'utilisation en laboratoire - Partie 1: Généralités Exigences.

European Union, European Free Trade Association (EFTA), and United Kingdom Compliance Notices

This equipment may be operated in the countries that comprise the member countries of the European Union and the European Free Trade Association. These countries, listed in the following paragraph, are referred to as The European Community throughout this document:

AUSTRIA, BELGIUM, BULGARIA, CYPRUS, CROATIA, CZECHIA, DENMARK, ESTONIA, FINLAND, FRANCE, GERMANY, GREECE, HUNGARY, IRELAND, ITALY, LATVIA, LITHUANIA, LUXEMBOURG, MALTA, NETHERLANDS, POLAND, PORTUGAL, ROMANIA, SLOVAKIA, SLOVENIA, SPAIN, SWEDEN, UNITED KINGDOM, ICELAND, LIECHTENSTEIN, NORWAY, SWITZERLAND

Declaration of Conformity

Marking by the "CE" symbol indicates compliance with the Essential Requirements of the EMC Directive of the European Union 2014/30/EU

This equipment meets the following conformance standards:

Safety

EN 61010-1: 2010 + A1: Safety Requirements for Electrical Equipment for Measurement, Control, and Laboratory Use - Part 1: General Requirements Low Voltage Directive 2014/35/EU

Emissions

EN 55032: 2015 + A11: 2020, CISPR 32: 2015, EN 61000-3-2: 2014, EN 61000-3-3: 2013

Immunity

EN 55035: 2017, EN 61000-4-2: 2009,

EN 61000-4-3: 2006 + A1: 2008 + A2: 2010, EN 61000-4-4: 2012,

EN 61000-4-5: 2014 + A1: 2017, EN 61000-4-6: 2014, EN 61000-4-8: 2010,

EN 61000-4-11: 2020

Environments: E2

Warnings



Warning! This is a Class A product. In a domestic environment, this product may cause radio interference, in which case, the user may be required to take appropriate measures.



Achtung! Dieses ist ein Gerät der Funkstorgrenzwertklasse A. In Wohnbereichen können bei Betrieb dieses Gerätes Rundfunkstörungen auftreten, in welchen Fällen der Benutzer für entsprechende Gegenmaßnahmen verantwortlich ist.



Attention! Ceci est un produit de Classe A. Dans un environnement domestique, ce produit risque de créer des interférences radioélectriques, il appartiendra alors à l'utilisateur de prendre les mesures spécifiques appropriées.

Notes:

1. For Compliance with the EMC standards listed here, high-quality shielded interface cables should be used.
2. Emissions which exceed the levels required by this standard may occur when this equipment is connected to a test object.

Environmental Compliance

This section provides information about the environmental impact of the product.

Product end-of-life handling

Observe the following guidelines when recycling an instrument or component:

Equipment recycling



Production of this equipment required the extraction and use of natural resources. The equipment may contain substances that could be harmful to the environment or human health if improperly handled at the product's end of life. To avoid release of such substances into the environment and to reduce the use of natural resources, we

encourage you to recycle this product in an appropriate system that will ensure that most of the materials are reused or recycled appropriately.

This symbol on the product or its packaging indicates that this product complies with the applicable European Union requirements according to Directives 2012/19/EU and 2006/66/EC on waste electrical and electronic - equipment (WEEE) and batteries.

It also indicates that this product must not be disposed of with your other household waste. Instead, it is your responsibility to dispose of your waste equipment by handing it over to a designated collection point for the recycling of waste electrical and electronic equipment. The separate collection and recycling of your waste equipment at the time of disposal will help conserve natural resources and ensure that it is recycled in a manner that protects human health and the environment. For more information about where you can drop off your waste for recycling, please contact your local authority, or where you purchased your product.

Battery Recycling

This product may contain a rechargeable battery, which must be recycled or disposed of properly. Please properly dispose of or recycle the battery according to local government regulations.

Transporting Batteries or products with Batteries in them

The capacity of the lithium-ion secondary battery shipped with this product is under 100 Wh. The lithium content of the installed primary battery is under 1 g. Each battery meets the applicable requirements of UN Manual of Tests and Criteria Part III Section 38.3. Battery quantity is under the limit for shipment according to Section II of the relevant Packing Instructions from the IATA Dangerous Goods Regulations. Consult your air carrier for applicability and determination of any special lithium battery transportation requirements.

Restriction of Hazardous Substances

This product is classified as an industrial monitoring and control instrument, and is required to comply with the substance restrictions of the RoHS 3 Directives 2011/65/EU and EU 2015/863.

Korea Compliance Statement

사용자 안내문

이 기기는 업무용 환경에서 사용할 목적으로 적합성 평가를 받은 기기로서 가정용 환경에서 사용하는 경우 전파간섭의 우려가 있습니다.

Taiwan Compliance Statement

警告使用者:

這是甲類的資訊產品，在居住的環境中使用時，可能會造成射頻干擾，在這種情況下，使用者會被要求採取某些適當的對策。

This is a Class A product based on the standard of the Bureau of Standards, Metrology and Inspection (BSMI) CNS 13438, Class A. In a domestic environment this product may cause radio interference, in which case the user may be required to take adequate measures.

Japan Compliance Statement

この装置は、クラス A 機器です。この装置を家庭環境で使用すると電波妨害を引き起こすことがあります。この場合には使用者が適切な対策を講ずるよう要求されることがあります。 VCCI-A

This is a Class A product based on the standard of the VCCI Council (VCCI 32: 2016). If this equipment is used in a domestic environment, radio interference may occur, in which case the user may be required to take corrective actions.

Important Safety Information

This manual contains information and warnings that must be followed by the user for safe operation and to keep the product in a safe condition. To safely perform service on this product, see the Service Safety Summary that follows the General Safety Summary.

General Safety Summary

Use the product only as specified. Review the following safety precautions to avoid injury and prevent damage to this product or any products connected to it. Carefully read all instructions. Retain these instructions for future reference.

Comply with Local and National Safety Codes

For correct and safe operation of the product, it is essential that you follow generally accepted safety procedures in addition to the safety precautions specified in this manual.

Product is Designed to be Used by Trained Personnel Only

Only qualified personnel who are aware of the hazards involved should remove the cover for repair, maintenance, or adjustment. Before use, always check the product with a known source to be sure it is operating correctly.

While using this product, you may need to access other parts of a larger system. Read the safety sections of the other component manuals for warnings and cautions related to operating the system.

When incorporating this equipment into a system, the safety of that system is the responsibility of the assembler of the system.

To Avoid Fire or Personal Injury

Use proper power cord: Use only the power cord specified for this product and certified for the country of use. Do not use the provided power cord for other products.

Ground the product: This product is grounded through the grounding conductor of the power cord. To avoid electric shock, the grounding conductor must be connected to earth ground. Before making connections to the input or output terminals of the product, ensure that the product is properly grounded. Do not disable the power cord grounding connection.

Power disconnect: The power cord disconnects the product from the power source. See instructions for the location. Do not position the equipment so it is difficult to operate the power cord; it must remain accessible to the user at all times to allow for quick disconnection if needed.

Observe all terminal ratings: To avoid fire or shock hazard, observe all rating and markings on the product. Consult the product manual for further ratings information before making connections to the product. Do not apply a potential to any terminal, including the common terminal, that exceeds the maximum rating of that terminal.

Do not operate without covers: Do not operate this product with covers or panels removed, or with the case open. Hazardous voltage exposure is possible.

Avoid exposed circuitry: Do not touch exposed connections and components when power is present.

Do not operate with suspected failures: If you suspect that there is damage to this product, have it inspected by qualified service personnel.

Disable the product if it is damaged. Do not use the product if it is damaged or operates incorrectly. If in doubt about safety of the product, turn it off and disconnect the power cord. Clearly mark the product to prevent its further operation.

Before use, inspect voltage probes, test leads, and accessories for mechanical damage and replace when damaged. Do not use probes or test leads if they are damaged, if there is exposed metal, or if a wear indicator shows.

Examine the exterior of the product before you use it. Look for cracks or missing pieces.

Use Only Specified Replacement Parts

Do not operate in wet/damp conditions: Be aware that condensation may occur if a unit is moved from a cold to a warm environment.

Do not operate in an explosive atmosphere.

Keep product surfaces clean and dry: Remove the input signals before you clean the product.

Provide proper ventilation: Refer to the manual's installation instructions for details on installing the product so it has proper ventilation.

Slots and openings are provided for ventilation and should never be covered or otherwise obstructed. Do not push objects into any of the openings.

Provide a safe working environment: Always place the product in a location convenient for viewing the display and indicators.

Be sure your work area meets applicable ergonomic standards. Consult with an ergonomics professional to avoid stress injuries.

Use only the Telestream rackmount hardware specified for this product.

Service Safety Summary

The Service Safety Summary section contains additional information required to safely perform service on the product. Only qualified personnel should perform service procedures. Read this Service Safety Summary and the General Safety Summary before performing any service procedures.

To avoid electric shock: Do not touch exposed connections.

Do not service alone: Do not perform internal service or adjustments of this product unless another person capable of rendering first aid and resuscitation is present.

Disconnect power: To avoid electric shock, switch off the product power and disconnect the power cord from the mains power before removing any covers or panels, or opening the case for servicing.

Use care when servicing with power on: Dangerous voltages or currents may exist in this product. Disconnect power, remove battery (if applicable), and disconnect test leads before removing protective panels, soldering, or replacing components.

Verify safety after repair: Always recheck ground continuity and mains dielectric strength after performing a repair.

Terms in the Manual

These terms may appear in this manual:



WARNING: Warning statements identify conditions or practices that could result in injury or loss of life.



CAUTION: Caution statements identify conditions or practices that could result in damage to this product or other property.

Terms on the Product

These terms may appear on the product:

DANGER indicates an injury hazard immediately accessible as you read the marking.

WARNING indicates an injury hazard not immediately accessible as you read the marking.

CAUTION indicates a hazard to property including the product.

Symbols on the Product

When this symbol is marked on the product, be sure to consult the manual to find out the nature of the potential hazards and any actions which have to be taken to avoid them. (This symbol may also be used to refer the user to ratings in the manual.)

The following symbol(s) may appear on the product:



General Safety Product Specific Statements

Use the product only as specified. Review the following safety precautions to avoid injury and prevent damage to this product or any products connected to it.

Carefully read all instructions. Retain these instructions for future reference.

Comply with local and national safety codes.

For correct and safe operation of the product, it is essential that you follow generally accepted safety procedures in addition to the safety precautions specified in this manual. The product is designed to be used by trained personnel only.

Only qualified personnel who are aware of the hazards involved should remove the cover for repair, maintenance, or adjustment.

Before use, always check the product with a known source to be sure it is operating correctly.

This product is not intended for detection of hazardous voltages.

Use personal protective equipment to prevent shock and arc blast injury where hazardous live conductors are exposed.

When incorporating this equipment into a system, the safety of that system is the responsibility of the assembler of the system.



WARNING: Injury or death can occur as the result of electrical shock. To avoid electrical shock, do not connect power to the instrument when the top cover is off. There are dangerous potentials present on the power supply circuit boards when the power cord is connected.

Disconnect the power cord from a power supply module before you remove the module from the instrument. Also, do not connect a power cord to a power supply module while the module is not installed in the instrument. There are dangerous high voltages on the module when the power cord is connected.



WARNING: Prevent risk of shock or fire by ensuring that the GNSS antenna is protected from lightning strikes when it is mounted outside a building or facility. The instrument does not have isolation protection from lightning, so the facility installation must provide suitable protection for the GNSS antenna external to the instrument and surge suppression for the cable. Failure to use appropriate precautions can result in injury or death. It is important the antenna and cable installation complies with all regulations for the location in which it is installed.



WARNING: To avoid personal injury and instrument damage, do not use slides provided with other instruments from other kits (for example, General Devices, Chassis Trak C-300) with the rails from this kit. The locking feature will not function and will result in an instrument that is not secured properly and could fall out of the rack, causing personal injury or instrument damage.



WARNING: To prevent the rack-mounted instrument from tipping forward onto the operator, install the instrument so the operator is able to access all of its rear-panel connectors without pushing down on the instrument. Verify that the rack does not become unstable with the instrument fully extended. Do not leave the instrument extended when finished accessing the rear panel.



WARNING: To reduce the risk of injury and equipment damage, make sure that levers are properly installed. An improperly installed lever can prevent the slide from locking or prevent the instrument from being removed from the rack. Make sure that the lever is installed so the long handle is facing forward and the short hook is facing downward.



WARNING: To prevent injury during product installation, use care not to pinch hands or fingers in the rails and slides.



WARNING: To prevent injury when removing the product from the rack, do not forcefully and abruptly pull the product from the rack. Pull with the minimum force required to move the instrument with a consistent, even motion.



CAUTION: The instrument does not have a power switch. When you connect the power cable to the AC line connector, the instrument powers on.

Do not install or remove a power supply module when a power cord is attached to that module.



CAUTION: To avoid antenna damage, do not turn on the DC antenna power until you know that the antenna is designed to handle the selected voltage. Antenna damage can occur if the antenna is not designed to handle the voltage you select.



CAUTION: Be careful to select the correct screw type for your instrument (metric or SAE). If the screws do not insert easily (do not use excessive force or you might damage the threads), it is possible you are using the wrong screw.



CAUTION: To prevent damage to the instrument and rackmount, do not force the instrument into the rack if it does not slide smoothly. The rails assembly might need to be adjusted to resolve the problem.



CAUTION: To prevent an unexpected shutdown of the instrument, be sure to disconnect the correct power cord if you are replacing a faulty power supply module.



CAUTION: The instrument might automatically reboot at the end of the upgrade process. Do not perform the upgrade while the instrument is in use as a sync reference. When the instrument has started to erase the internal flash, do not remove power from the instrument.



CAUTION: To prevent static damage to the SFP modules, if you remove the SFP modules from the instrument, always transport the SFP modules in an anti-static bag or container.



CAUTION: To prevent damage to the SFP modules, remove the SFP modules before transporting the SPG instrument.



CAUTION: To prevent dust from contaminating the SFP module, use its cover when the SFP is not in use. If SFP modules or fiber optic cable have been left exposed, we recommend it is cleaned before use. This is especially important on the long-reach, single-mode SFP modules and fiber.



CAUTION: We strongly recommend using the timeout function to keep the display backlight at a low level when the front-panel interface is not actively being used, to maximize the life of the display backlight.

Preface

This manual contains information to help you use the SPG9000 timing and reference system:

- How to operate the instrument using the front-panel controls
- How to configure the instrument for network access and operate the instrument using the web interface
- How to monitor the status of the instrument during normal operation

Where to Find More Information

Other information about your product are available for download at www.telestream.net/video/resources.htm. The Product Documentation table lists all the documentation for the SPG9000 timing and reference system.

Document	Manual type	Part number	Description
SPG9000 User Manual	User	D00013571x	Provides detailed operating information.
Release Notes	Release Notes	D00013575x	Describes the new features, improvements, and limitations of the instrument firmware.
Read-this-first	User	P00010592x	Lists all relevant documents.
SPG9000 Installation and Safety Instructions	User	P00010606x	Describes how to install and set up a SPG9000 generator, and provides basic safety and operating information.
Manual, Rackmount Slides and Rails Kit	User	071370600x	Describes how to connect rack equipment to an SPG9000 generator. Provides basic safety information.

Telestream Contact Information

To obtain product information, technical support, or provide comments on this guide, contact us using our website, email, or phone number listed.

Resource	Contact Information
Telestream Video Support	Website: www.telestream.net/telestream-support Email: videosupport@telestream.net US and Canada Toll-free: 1-844-219-5329 Outside of US and Canada: 1-503-967-9833
Telestream	Website: www.telestream.net Sales and Marketing Email: info@telestream.net Address: Telestream 848 Gold Flat Road, Suite 1 Nevada City, CA. USA 95959
International Distributor Support	Website: www.telestream.net See the Telestream website for your regional authorized Telestream distributor.
Telestream Technical Writers	Email: techwriter@telestream.net If you have comments or suggestions about improving this document, or other Telestream documents—or if you've discovered an error or omission, please email us.

Product Description

The SPG9000 is a precision multiformat video signal generator and timing system, suitable for primary synchronization and reference applications. It provides multiple video, audio, and time reference signals, and it can synchronize to different reference sources. The instrument uses optional licenses to enable additional functionality, such as GNSS-based synchronization, PTP (Precision Time Protocol) support, and test signal generation for SDI and ST 2110 IP interfaces. The images show the front and back of the SPG9000.

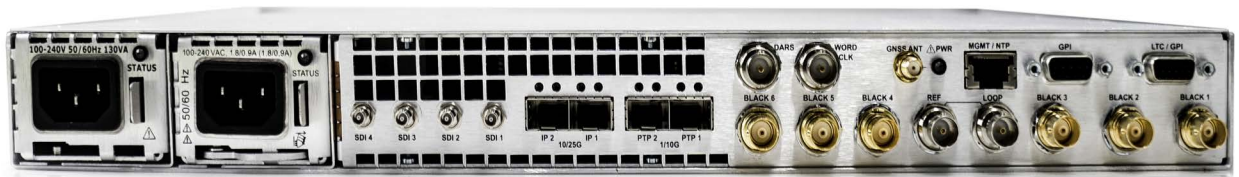

Base Capabilities

These capabilities and hardware are available on all SPG9000 instruments.

The SPG9000 has six sync outputs that can be configured with independent output formats (NTSC/PAL black burst and/or HD tri-level sync) and independently adjustable timing offsets. It includes two dedicated audio reference signal outputs: a 48 kHz word clock output and an AES DARS (Digital Audio Reference Signal) output.

A high-accuracy, oven-controlled micro-electromechanical system (MEMS) oscillator provides a stable frequency reference for the system, or the loop-through genlock input can be used to lock to an external video reference or 10 MHz continuous wave signal. The Stay GenLock® feature avoids synchronization shock, which can result in many possible video and audio errors because of a sudden change in timing. If the external reference suffers a temporary disturbance, Stay GenLock® maintains the frequency and phase of each output signal. When the external reference is restored, Stay GenLock® ensures that any accumulated clock drift is removed by slowly adjusting

the system clock instead of suddenly forcing the system clock back to the correct phase.

Time reference outputs are available in multiple formats. One LTC (linear time code) connection can be used as input or output, and three additional independent LTC outputs are available. Each LTC output has independent frame rate selection, time source (time of day or program time) and time zone offset. VITC (vertical interval time code) is available on each NTSC or PAL black output, also with independent time sources and offsets. The SPG9000 can function as a Network Time Protocol (NTP) server, and it can function as an NTP client to set the current time.

For remote access to the instrument, a 10/100/1000BASE-T Ethernet interface is included. A web-based user interface can be used for all configuration settings and for monitoring system status. A web-services application programming interface can be used for all configuration settings and to get status and performance monitoring information; this enables easy integration with management and dashboard systems. System events can be logged to a remote server using Syslog. The Simple Network Management Protocol (SNMP) is available for querying system status and for event notifications. An electrical General Purpose Interface (GPI) is available for events and alarms.

Optional Capabilities

These capabilities are available as separately licensed features and can be added to any SPG9000 at the initial time of purchase or as a later upgrade.

Optional GNSS-based Synchronization

Option SPG9000-GNSS enables an integrated receiver inside the SPG9000 that can receive GNSS (Global Navigation Satellite System) signals from multiple satellite constellations (GPS, GLONASS, BeiDou, Galileo, and QZSS) and frequency bands (L1 and L5). When connected to an external antenna that supplies the standard GNSS RF signal (for example, SPG9000-ACC-ANT), the SPG9000 can use the GNSS system's stable frequency reference.

The GNSS signal also includes a precise time-of-day reference that can be used for all time code outputs. Similar to the Stay GenLock® feature, the SPG9000 can maintain the video frequency and phase when the GNSS signal is interrupted, and the Holdover Recovery mode ensures a shock-free realignment of frequency and phase when the GNSS signal is restored.

Optional PTP Support

Option SPG9000-PTP enables two PTP (Precision Time Protocol) engines for IP network-based synchronization. Two SFP+ ports provide two network interfaces that can operate at 1 Gbps or 10 Gbps depending on the SFP module type. Each port has an independent PTP instance that can operate as a leader (grandmaster), follower, or as an Ordinary Clock that can adaptively change between leader and follower states. With

two instances, the SPG9000 can operate as a dual leader, providing PTP to two separate networks (such as a primary + backup network pair as used by ST 2022-7); as a dual follower, synchronized to the GM on either the primary or backup network; or as a follower on one network and a leader on another, bridging the two separate PTP domains. A follower instance can be used to monitor PTP operation on the network without having to function as the reference source of the instrument.

The SPG9000 supports IEEE 1588, ST 2059-2 and AES67 profiles, and each instance can operate with multicast, unicast, or mixed communication models.

The status of each instance, including performance monitoring measurements such as offsets, delays and message rates can be viewed on the web interface or retrieved by the web services API for integration into management dashboard systems.

The black outputs support a 1 PPS output signal. This is useful for measuring timing between systems.

Optional Test Signal Outputs

The SPG9000 includes video, audio, and data test signal generation for a variety of formats on multiple outputs. Option SPG9000-SDI enables four SDI (Serial Digital Interface) outputs capable of SD (Standard Definition), HD (High Definition), or UHD (Ultra High Definition) signals at interface rates up to 12G-SDI. Option SPG9000-IP enables two SFP28 ports for ST 2110 IP stream generation over 25 Gbps or 10 Gbps interfaces, depending on the SFP type. IP streams can be configured manually from the SPG9000 user interface or from an NMOS-enabled connection manager.

The SPG9000 includes a wide variety of predefined test patterns, such as different types of color bars, ramps, or SDI pathological signals. Additionally, user-supplied image files of custom test patterns or photographic content can be uploaded to the instrument and used for the video outputs. Overlays such as ID text, time code, or a color logo can be added to the image. Embedded audio in SDI signals or ST 2110-30 IP audio streams can be configured as tones with a specific amplitude and frequency. Ancillary data in the form of time code can also be generated.

Optional Backup Power Supply

For critical applications, the instrument can be configured with a second power supply module. Under normal operation, the designated backup supply is seldom used, ensuring that it has maximum remaining life should the primary supply fail. The backup supply is load-tested each day to verify that it can serve as the primary supply if necessary. The usage time of each supply is logged as “temperature-weighted hours”, a metric that best estimates the calculated life of the supply. A front-panel LED indicates when the supply is nearing its end-of-life. If the primary supply is interrupted for any reason, the system switches to the backup without any disruption to system operation. Power supply modules are hot-swappable for easy replacement and feature a locking mechanism to prevent the power cable from accidental disconnection.

Instrument Installation

This section describes:

- how to install the SPG9000 into a standard 19-inch equipment rack, it includes a list of the parts in the mounting kit and the required tools (not included),
- how to connect the SPG9000 to external power,
- the physical connectors on the rear panel of the instrument and which signals are used with each connector,
- how to install and remove SFP modules, and
- how to connect an external GNSS antenna and its associated cables.

Rackmount Installation

The SPG9000 is typically installed in a standard 19-inch equipment rack. The rack mount kit consists of a pair of slides that are attached to the SPG9000 and a pair of rails that are attached to the rack. This section describes how to install the slides and rails.

The rack mount kit can be ordered as option SPG9000-RACK at the same time as the base unit. In this case, the slides are pre-installed onto the SPG9000 before it is shipped. The kit can also be ordered as SPG9000-ACC-RACK as a standalone kit after the initial purchase.

Kit Parts List

The slides assembly parts list has the parts contained in this kit. The associated figures show what the parts look like. If your kit was shipped with your instrument, the slides are already installed.

Slides assembly parts list

Number in example	Qty	Name and description
1	2	BRACKET, RACK, CHASSIS-SIDE
2	2	BRACKET, RACK, LEVER, CHASSIS-SIDE
	2	BUSHING, RACK, CHASSIS-SIDE
3	2	SCREW, MACHINE; 8-32 X 0.5, FLH, 100 DEG, STL, ZN PL, PHIL (SAE)
	6	SCREW, MACHINE; 8-32 X 0.375, PNH, STL, ZN PL, PHIL (SAE)
4	2	SCREW, MACHINE; M4X10MM L, FLH, STL, ZN PL, PHIL (metric)
	6	SCREW, MACHINE; M4 X 8MM L,PNH, STL, ZN PL, PHIL (metric)

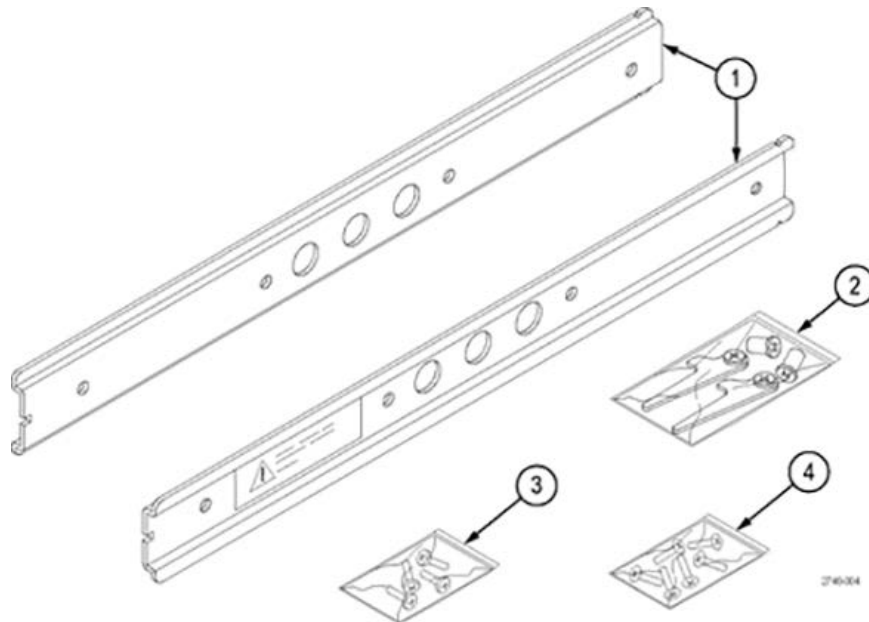

Rails assembly parts list

Number in example	Qty	Name and description
1	2	BRACKET, RACK, STATIONARY
2	2	BRACKET, RACK, REAR CABINET
3	2	BRACKET, RACK, BAR NUT
	8	SCREW, MACHINE; 10-32 X 0.625,TRH, ZINC PLATED STEEL, PHIL
	4	NUT ASSY; 10-32 X 0.375 HEX, ZINC PLATED STEEL, LOCK WASHER

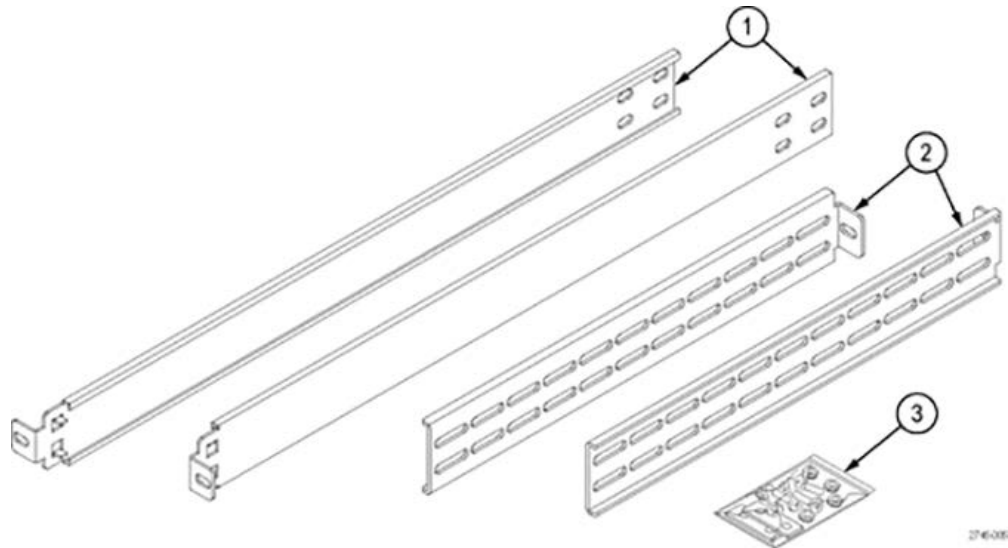

Installation Instructions

This section provides instructions:

- Installing the slides onto the SPG9000 if they are not already installed
- Installing the rails into a standard 19-inch equipment rack
- Installing the instrument into the rails in the rack



WARNING: To avoid personal injury and instrument damage, do not use slides provided with other instruments from other kits (for example, General Devices, Chassis Trak C-300) with the rails from this kit. The locking feature will not function and will result in an instrument that is not secured properly and could fall out of the rack, causing personal injury or instrument damage.

Equipment List

These tools are required to install the kit hardware:

- #2 crosshead screwdriver
- 3/8-inch wrench



WARNING: To prevent the rack-mounted instrument from tipping forward onto the operator, install the instrument so the operator is able to access all of its rear-panel connectors without pushing down on the instrument. Verify that the rack does not become unstable with the instrument fully extended. Do not leave the instrument extended when finished accessing the rear panel.

Install Slides

Screw Selection

For the slides installation, this kit provides two sets of screws (metric and SAE), but the SPG9000 only needs the 3 metric screws.

Procedure

Attach the slides to the instrument:

Note: The slides might already be installed on your instrument. If they are, skip this procedure and go to Installing the Rails.

1. Identify the right rear and left rear of each slide. A warning label is on the outside side of each slide.
2. Make sure that the rear of the slide is nearest to the rear of the instrument. The front of each slide has a notch in the center edge.
3. Align the mounting holes on the right slide to the mounting holes on the right side of the instrument.
4. Use the shorter screws provided (8mm) and a screwdriver with a #2 Phillips tip; attach the right slide to the right side of the instrument:



CAUTION: Be careful to select the correct screw type for your instrument (metric or SAE). If the screws do not insert easily (do not use excessive force or you might damage the threads), it is possible you are using the wrong screw.

- A. Insert the metric screws into the first two mounting holes.
- B. Place the lever, with the long handle facing the front of the slide and the short hook facing downward, over the remaining mounting hole.
- C. Insert a metric screw into the bushing for the lever.
- D. Insert the bushing and screw into the lever so the lever is attached to the slide and the slide is secured to the instrument.

The example shows how to attach the slide levers for the SPG9000 instrument.

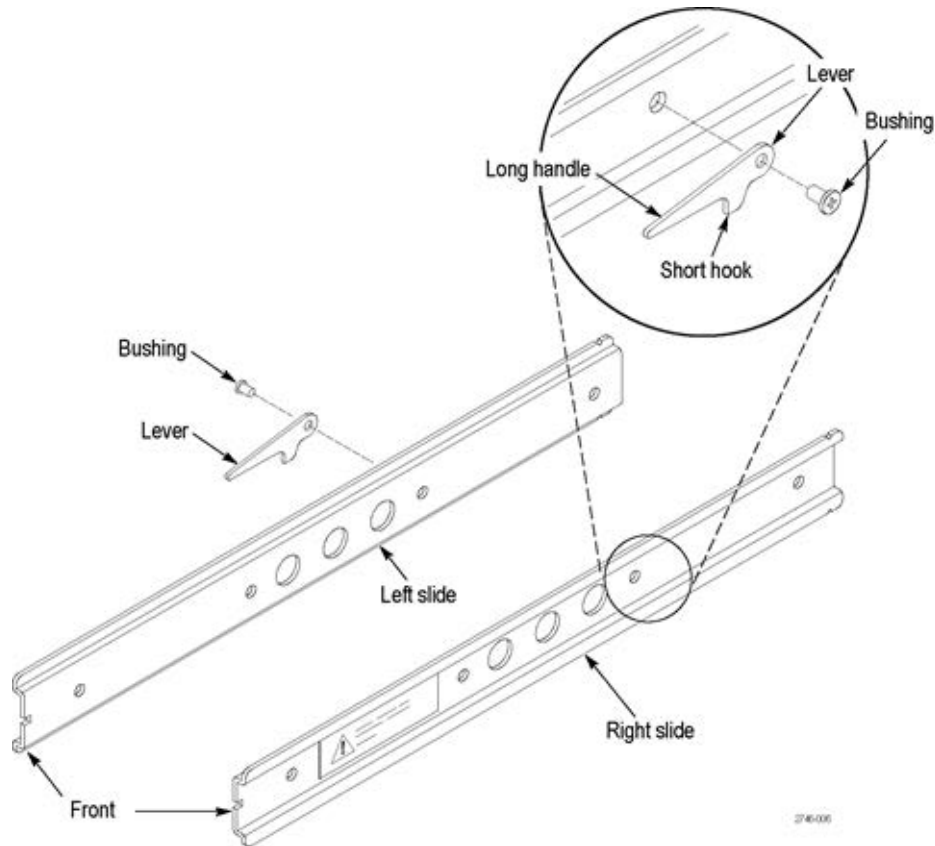

5. Rotate the instrument to face the left side and repeat this procedure to install the left slide.



WARNING: To reduce the risk of injury and equipment damage, make sure that levers are properly installed. An improperly installed lever can prevent the slide from locking or prevent the instrument from being removed from the rack. Make sure that the lever is installed so the long handle is facing forward and the short hook is facing downward.

Install Rails

This two-part procedure describes how to assemble and install the rails in the equipment rack.

Assemble Rails

1. Measure the distance between the front and rear rail of the equipment rack.
2. Align the rear bracket to the right rail. Notice that the rear bracket has multiple pairs of mount-through holes. When aligning the bracket and rail, be sure to select a pair

of holes that mount the rear bracket so the flange-to-flange distance matches the front rail to rear rail spacing of the rackmount rack just measured in step 2.

3. Using a screwdriver with a #2 Phillips tip, attach the rear bracket to the right rail using two 10-32 screws and 10-32 nuts or a bar nut as necessary. Leave the screws loose so you can adjust the overall length of the rail assembly in the rack.
4. Repeat this procedure to assemble the left rail assembly.

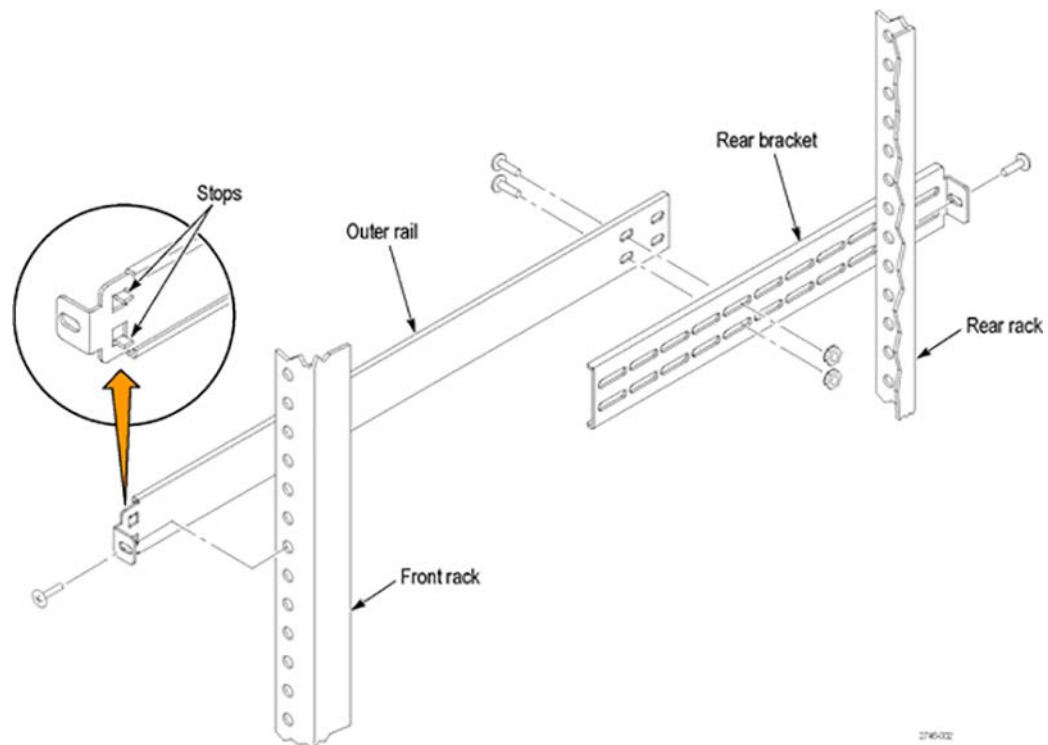

Mount Rails

1. Select a 1/2-inch-spaced hole in the front rack.
2. Select the mounting method according to your rack type:
 - Mount the rails with their front and rear flanges *outside* the front and rear racks; add a bar nut to the installation only if the rails have untapped holes.
 - Mount the rails with their front and rear flanges *inside* the front and rear racks; add a bar nut. This mounting method assumes untapped holes.
 - Some racks have square mounting holes and require cage nuts to be inserted. These are supplied from the rack vendor.
3. Using the method and hardware determined from step 2, attach the right rail assembly to the equipment rack front and rear rails. The screws should be fully, but lightly, seated so you can adjust the rack later.
4. Tighten the screws still loose when you assembled the rails, apply 28 inch-lbs of torque, to fix the front to rear flange spacing of the rail assembly.
5. Repeat this procedure to mount the left rail assembly.

Install Instrument in Rack

This procedure describes how to install the instrument into the equipment rack.



WARNING: To prevent injury during product installation, use care not to pinch hands or fingers in the rails and slides.

1. Insert the instrument left and right slides into the ends of the rack rails while tilting the long handle of each lever upward.

Note: Be sure to insert the instrument slides *inside* the inner rack rails. You might need to tilt rear of the instrument up or down at a slight angle to fit the slides into the rails.

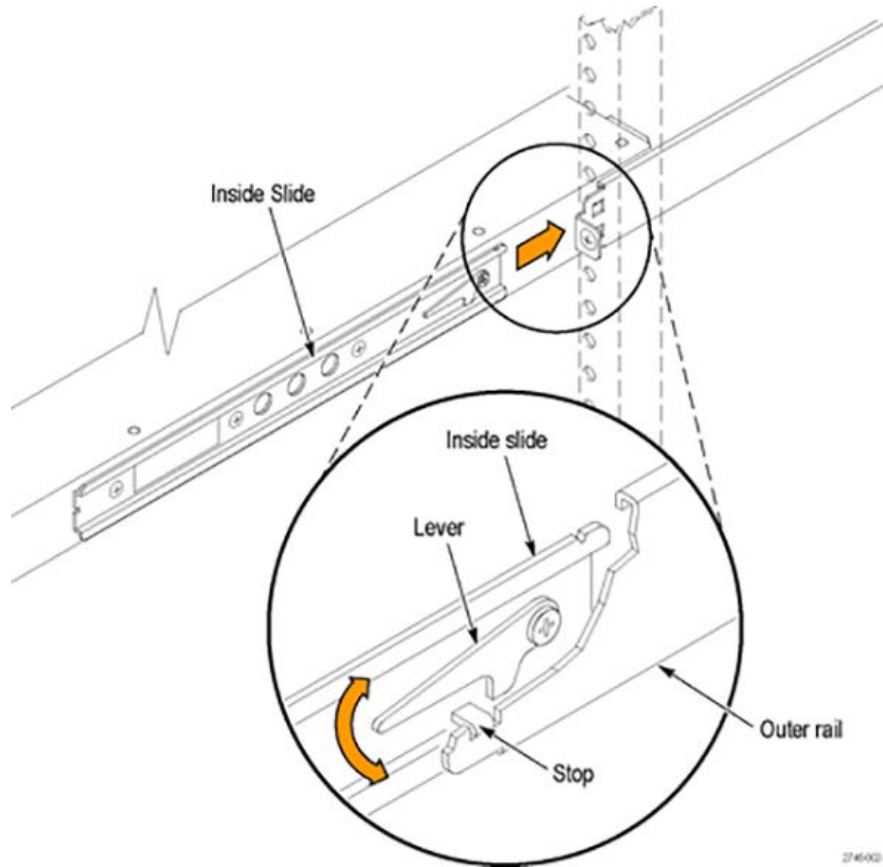

2. Push the instrument into the rack until it stops.



CAUTION: To prevent damage to the instrument and rackmount, do not force the instrument into the rack if it does not slide smoothly. The rails assembly might need to be adjusted to resolve the problem.

3. Retighten any loose screws and push the instrument all the way into the rack. If the tracks do not slide smoothly, readjust the rail assemblies.
4. When adjusting is completed, tighten all rail assembly 10-32 screws.
5. If the instrument has knob screws on the front corners, tighten them so they are secured in the rack.

Remove Instrument from Rack

This procedure describes how to remove the instrument from the equipment rack.



WARNING: To prevent injury when removing the product from the rack, do not forcefully and abruptly pull the product from the rack. Pull with the minimum force required to move the instrument with a consistent, even motion.

1. Loosen the knob screws, if present, at the front of the instrument.
2. Gently pull the instrument out until you can reach the levers on the inside slides.
3. Tilt both lever handles upward at the same time to clear the stops.

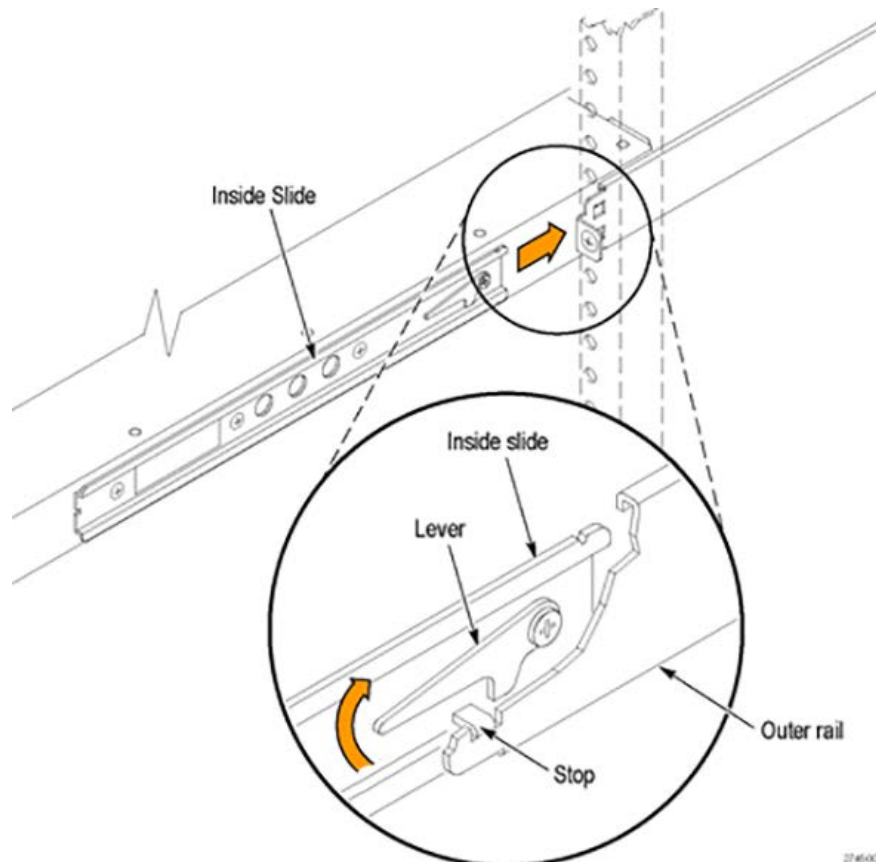

4. Pull the instrument past the stops and out of the rack.

Power Connection

The instrument operates from a single-phase power source with the neutral conductor at or near earth ground. The line conductor is fused for over-current protection. A protective ground connection through the grounding conductor in the locking power cord is essential for safe operation.

With option SPG9000-SPW, a single power supply module is installed. With option SPG9000-DPW, a second, hot-swappable, redundant (backup) power supply module is also installed. When two power supply modules are installed in the instrument, one is configured to be the primary supply and the other is configured to be the backup supply. In the event that the primary supply fails, the backup supply automatically provides power to maintain instrument operation. See [Power Supply Monitoring and Replacement](#) about how to operate the instrument with two power supplies.



WARNING: Injury or death can occur as the result of electrical shock. To avoid electrical shock, do not connect power to the instrument when the top cover is off. There are dangerous potentials present on the power supply circuit boards when the power cord is connected.

Disconnect the power cord from a power supply module before you remove the module from the instrument. Also, do not connect a power cord to a power supply module while the module is not installed in the instrument. There are dangerous high voltages on the module when the power cord is connected.

Power Characteristics

AC power source

Rating voltage 100 V to 240 V



WARNING: To reduce the risk of fire and shock, ensure the mains supply voltage fluctuations do not exceed 10% of the operating voltage range.

Frequency 50 or 60 Hz

Typical power 130 VA

Maximum power 180 VA

Surge current, typical 20 a peak (25 °C) for ≤ 5 lines cycles, after the instrument has been turned off for at least 30 seconds.

Inrush current, typical 10 A RMS half cycle at initial turn on according to EN55103-1:2009 Annex B.

CAUTION: The instrument does not have a power switch. When you connect the power cable to the AC line connector, the instrument powers on.

Do not install or remove a power supply module when a power cord is attached to that module.

Connect Power

Connect the power cable to the instrument first and then connect it to the AC power source. Connecting the power cable causes the instrument to power on. If there is a backup power supply (option SPG9000-DPW), connect the second power cable to the instrument and then connect it to the AC power source.

After the instrument boots up and initializes, check that the FAULT indicator on the front panel is not illuminated and no faults are reported on the instrument display. If the FAULT indicator is illuminated, take the appropriate action.

Each power supply module has an LED (labeled STATUS) visible on the rear panel that mirrors the corresponding PWR indicator on the front panel. Under normal conditions, the LED for the active power supply is bright green and the LED for the backup power supply is dim green. See [FAULT](#) and [PWR 1 and PWR 2](#) for descriptions of the FAULT and PWR indicators.

Rear Panel Connectors

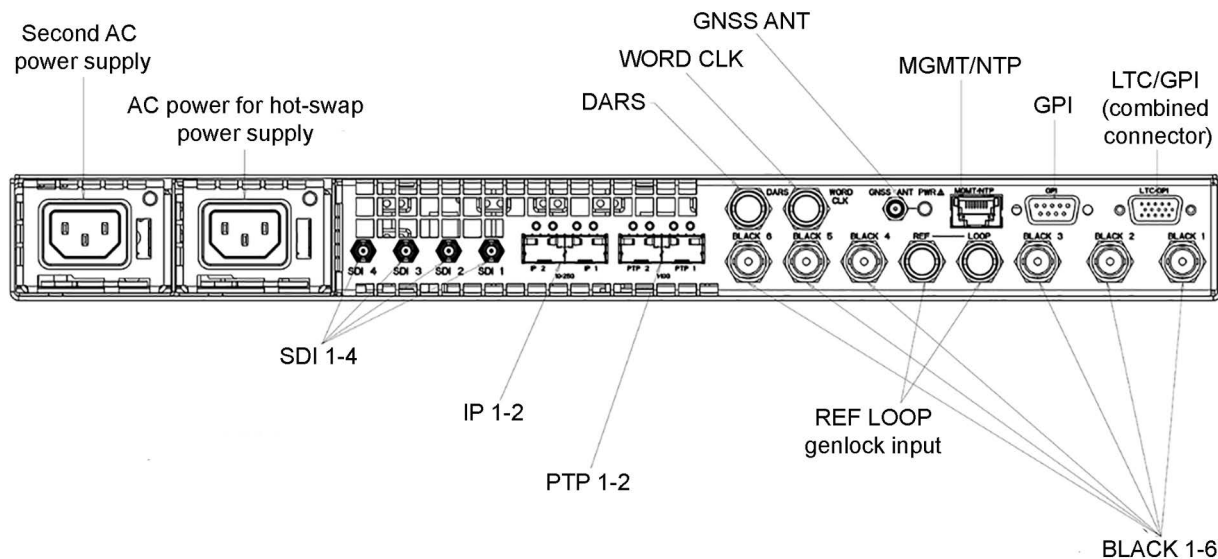

The descriptions of the connectors start with the base outputs on the right and move to the optional outputs on the left.

LTC/GPI Connector

The LTC/GPI connector is a 15-pin, D-sub connector (DE-15 socket) that includes both Linear Time Code (LTC) input and outputs, and a subset (3 inputs and 2 outputs) of the General Purpose Interface. See [Linear Time Code Input and Outputs](#) and [General Purpose Interface](#).

A breakout cable is available for this connector with XLR connectors for the four LTC outputs and BNC connectors for the GPI input (1 only) and outputs (1-2 only). It can be ordered as option SPG9000-XLR at the same time as the base SPG9000 purchase or as SPG9000-ACC-XLR, a standalone accessory purchased later.

In addition, the pin assignments were selected so a standard RGBHV cable can be used for a subset of signals. These cables have been used to connect VGA computer output to the component video inputs of a CRT monitor, with a DE-15-pin connector at one end and five BNC connectors at the other end.

The pin assignments for the connector are shown, with the RGBHV BNC connector shown if available:

Pin	Function	RGBHV Cable	Diagram
1	GPI output 1	Red BNC	
2	GPI output 2	Green BNC	
3	GPI input 1	Blue BNC	
4	GPI input 2		
5	LTC 4 negative		
6	Ground	Ground	
7	LTC 3 negative	Ground	
8	LTC 2 negative	Ground	
9	Ground		
10	LTC 1 negative	Ground	
11	GPI input 3		
12	LTC 3 positive		
13	LTC 2 positive	H BNC	
14	LTC 1 positive	V BNC	
15	LTC 4 positive		

GPI Connector

The General Purpose Interface (GPI) connector is a 9-pin, D-sub connector (DE-09 socket) that includes four ground closure inputs and three ground closure outputs. See [General Purpose Interface](#).

The pin assignments for the connector are:

Pin	Function	Diagram
1	Ground	
2	GPI output 1	
3	GPI output 2	
4	GPI input 1	
5	+5 V (1 kΩ source resistance, limited current)	
6	GPI output 3	
7	GPI input 4	
8	GPI input 3	
9	GPI input 2	

MGMT/NTP Port

The Management/NTP port uses an 8P8C (RJ45) connector to connect to your local Ethernet network, with an interface speed of 1 Gbps, 100 Mbps, or 10 Mbps. You can control the instrument remotely through the port to connect to the web-based user interface or the web services API. See [Management Network Interface](#).

This network interface is also used for NTP (Network Time Protocol) messages. See [Network Time Protocol](#).

GNSS ANT Connector

With option SPG9000-GNSS, the GNSS antenna connector (SMA female) allows you to synchronize the instrument timing to one or more GNSS (Global Navigation Satellite Systems). The integrated receiver supports the global GPS (United States), GLONASS (Russia), BeiDou (China), and Galileo (European Union) systems, and the regional QZSS (Japan) system. You must connect a GNSS antenna to the instrument to use this functionality. The GNSS antenna input must meet specific requirements. See [Antenna Requirements](#).

You can enable this connector to provide 3.3 V or 5 V DC power to the antenna, or disable power if the antenna is externally powered. When the connector is configured to provide power to the antenna, the rear-panel GNSS ANT indicator is illuminated:

- Blinks green to indicate an open circuit. This occurs if no antenna is connected or if the current load is less than expected because a splitter or DC block is being used.
- Displays solid red if the connected antenna is shorted.
- Displays solid green if the current load of the antenna is within the nominal range.

See [GNSS Receiver Settings](#).

WORD CLK Output Connector

The Word Clock connector (BNC) outputs a 48 kHz word clock signal. See [Audio Reference Outputs](#).

DARS Output Connector

The DARS connector (BNC) outputs an AES11 DARS (Digital Audio Reference Signal) signal. See [Audio Reference Outputs](#).

BLACK 1–6 Output Connectors

The six BNC connectors labeled BLACK 1 to BLACK 6 are used to each output a black burst (NTSC or PAL), HD tri-level sync, 1 PPS (pulse-per-second) or 10 MHz CW (continuous wave) signal.

Note: The 10 MHz CW signal is only available on the BLACK 3-6 outputs.

You can set the format and timing of the six black outputs independently and enable VITC to be applied to the output signal. For HD tri-level sync signals, the BLACK 1-3 and BLACK 4-6 outputs are independent groups. Within each group, any of the three outputs configured to a tri-level format must have all integer (25, 24, 30, etc.) or non-integer (29.97, 23.98, etc.) frame rates. See [Black Outputs](#).

REF LOOP Input Connectors

Use the Reference Loop input loop-through connectors (BNC) for an external reference signal (genlock input), which can be an NTSC/PAL black burst or HDTV tri-level sync signal. The reference input requires proper external termination. The signal can connect to other devices through the loop connection; however, the signal must be terminated eventually, either on the instrument or at the other device. See [Genlock Reference](#).

PTP 1-2 Ports

With option SPG9000-PTP, the PTP 1 and PTP 2 ports are enabled. Each port corresponds to an independent PTP instance. Two SFP+ slots are provided for use with SFP modules that can operate at 10 Gbps or 1 Gbps line speed depending on the SFP type.

These SFP modules are available as accessory options:

SPG9000-SFP-1GESR	1 G (gigabit) Ethernet, short reach, 850 nm SFP transceiver module
SPG9000-SFP-10GESR	10 G Ethernet, short reach, 850 nm SFP+ transceiver module
SPG9000-SFP-10GELR	10 G Ethernet, long reach, 1310 nm SFP+ transceiver module

See [PTP Configuration](#).

These two Ethernet ports have LEDs that show the current link status. The left LED is green when the link is up and flickers when there is network activity. The right LED is green when the interface operates at the 10 Gbps line rate, but it is not on when the interface operates at the 1 Gbps line rate.

IP 1-2 Ports

With option SPG9000-IP, the IP 1 and IP 2 ports are enabled for generation of ST 2110 IP streams of video, audio, and data test signals. Two SFP28 slots are provided for use with SFP modules that can operate at 25 Gbps or 10 Gbps line speed depending on the SFP type.

These SFP modules are available as accessory options:

SPG9000-SFP-10GESR	10 G (gigabit) Ethernet, short reach, 850 nm SFP+ transceiver module
SPG9000-SFP-10GELR	10 G Ethernet long reach, 1310 nm SFP+ transceiver module
SPG9000-SFP-25GESR	25 G Ethernet short reach, 850 nm SFP28 transceiver module
SPG9000-SFP-25GELR	25 G Ethernet, long reach, 1310 nm SFP28 transceiver module

See [Video Sources](#) and [Audio Sources](#) for how to configure the test signal content and [IP Streams](#) for how to configure the transmitted IP streams.

SDI 1-4 Output Connectors

With option SPG9000-SDI, the SDI 1 to SDI 4 outputs are enabled for test signal generation through HD-BNC connectors. Each output has an independent line rate of SD-SDI (270 Mbps), HD-SDI (1.5 Gbps and 3 Gbps), or UHD (6G-SDI and 12G-SDI).

See [Video Sources](#) and [Audio Sources](#) for how to configure the test signal content, and [SDI Outputs](#) for how to configure the SDI signals.

SFP Module Installation

This section explains how to install and remove an SFP module from an SPG9000.

Install SFP Module

1. Remove the protective plug from the SFP connector.
2. Insert the SFP module into the PTP connector on the rear-panel of the instrument as shown. The module latches into place when fully inserted.

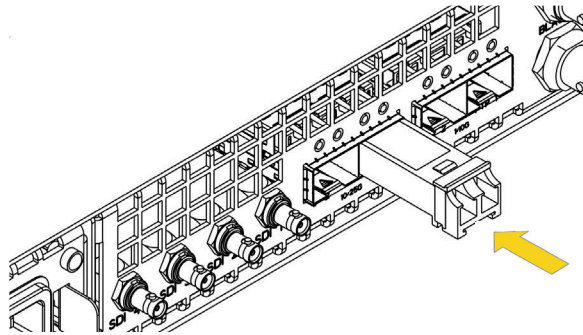

Remove SFP Module

Pull down on the latch and pull the module out of the PTP connector as shown.

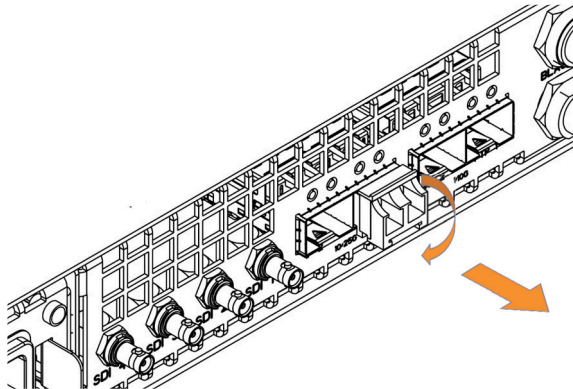

The SFP module should be removed from the generator while the instrument is being transported.



CAUTION: To prevent damage to the SFP modules, remove the SFP modules before transporting the SPG instrument.



CAUTION: To prevent static damage to the SFP modules, if you remove the SFP modules from the instrument, always transport the SFP modules in an anti-static bag or container.



CAUTION: To prevent dust from contaminating the SFP module, use its cover when the SFP is not in use. If SFP modules or fiber optic cable have been left exposed, we recommend cleaning it before use. This is especially important on the long-reach, single-mode SFP modules and fiber.

GNSS Antenna Installation

If your instrument has option SPG9000-GNSS enabled, you need to connect a GNSS antenna and check the main oscillator calibration before you put the instrument into service.

If you ordered SPG9000-ACC-ANT, you received a GNSS rooftop antenna (5.0 VDC, dual-band (L1 and L5), type-N connector) that is matched with the internal GNSS receiver.

Note: The SPG9000-ACC-ANT antenna uses a type-N connector and the SPG9000 has an SMA female connector for the antenna input. You might have to build a custom cable with the appropriate connectors at each end, or use adapters with existing cables.

After installation, see [GNSS Receiver Settings](#).

Antenna Requirements

The instrument requires an external antenna to receive GNSS signals from satellites. You must set up an antenna system to provide the GNSS signal as an input to the instrument. You can configure the instrument to provide 3.3 V or 5 V DC power for the antenna.



WARNING: Prevent risk of shock or fire by ensuring that the GNSS antenna is protected from lightning strikes when it is mounted outside a building or facility. The instrument does not have isolation protection from lightning, so the facility installation must provide suitable protection for the GNSS antenna external to the instrument and surge suppression for the cable. Failure to use appropriate precautions can result in injury or death. It is important the antenna and cable installation complies with all regulations for the location in which it is installed.



CAUTION: To avoid antenna damage, do not turn on the DC antenna power until you know that the antenna is designed to handle the selected voltage. Antenna damage can occur if the antenna is not designed to handle the voltage you select.

Note: The frequencies for the different GNSS systems are slightly different from each other. Be sure to choose an antenna that supports all of the satellite constellations you intend to use. We recommend you use an antenna, amplifiers, and splitters that can receive signals from multiple GNSS systems and frequency bands. This allows the instrument timing to be more stable because a GNSS antenna can communicate with more satellites.

When a GNSS signal is first connected to the antenna input on the instrument, it can take several minutes for the signal quality to reach its nominal potential. How long that takes depends on such things as antenna site, cable plant design, and available satellites. Excluding those variables, the typical time to acquire satellites and achieve specified stability with a good satellite signal, known position, and a warmed up instrument, is two minutes.

Antenna Systems

Antenna systems vary depending on the operating environment and on safety and regulatory requirements. A simplified GNSS antenna and cable block diagram is shown to help you with planning and understanding the trade-offs of one setup versus another.

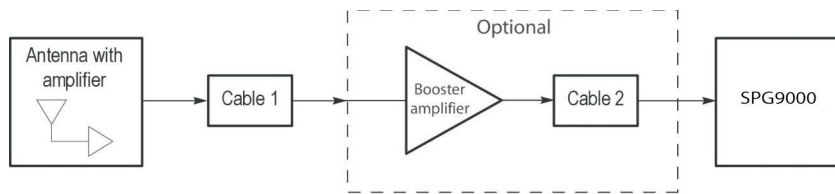

A GNSS-specific antenna with amplifier provides sufficient gain to drive a reasonable length of cable, and provides filtering to reject signals at other frequencies. A typical example for GNSS signals is the Protempis Bullet™ 720, 35±3 dB, 5 V antenna.

In a simple system without the optional booster, Cable 1 connects the antenna to the instrument. The length of this cable is limited by its attenuation at the carrier frequency (L1: 1559~1610 MHz, L5: 1164~1214 MHz). The instrument should have a signal that is 18 dB or greater above the ambient level. For example, for a 35 dB antenna, the allowed loss is 17 dB.

Antenna Location

It is important that the GNSS antenna location has a clear view of a large part of the sky. Because GNSS satellites are constantly orbiting the earth, they can be in any direction at a given time. If part of the sky is blocked by buildings, trees, mountains, etc., then fewer satellites are visible. It is also possible to get reflected signals that come by a longer path than expected, which can degrade timing accuracy and stability. When evaluating a site, it is important to monitor it over several days and with a variety of weather conditions present.

This antenna information is not intended to cover all aspects of the antenna system design. Important topics that were not covered include items like lightning protection and drip loops. For information about the cable plant design in your system, contact the appropriate person or group in your organization, or contract with a qualified installer.

Cables

Attenuation varies significantly depending on cable type. Cable loss is about 13 dB/100 ft for a miniature coaxial cable like the Belden 1855, while for a RG 1 style like the Belden 7731, the loss is only 5.5 dB/100 ft. This correlates to an allowable length of 130 ft for the small cable, to over 300 ft for the larger cable.

A booster amplifier can be added if more length is needed, as shown in the optional block in the signal path system. The booster amplifier should be closer to the antenna than to the SPG9000.

If a 20 dB amplifier is added, then 20 dB more cable loss can be accommodated. This equates to another 150 ft of small coaxial cable, or 360 ft of large coaxial.

Although the GNSS input and most of the other components are 50 Ω , either 50 Ω or 75 Ω cables can be used in most installations. The reflections from the impedance mismatch will not cause significant changes in the system because the signal is narrow band and the cable loss is usually many decibels. However, you should not mix short cable lengths of different impedances, as this might create reflections with the potential to cause signal degradation.

Amplification

The instrument provides either 3.3 V or 5 V DC power to drive the amplified antenna and booster amplifier. The power is carried on the same coaxial cable as the GNSS signal and can be turned off if the antenna is powered by a separate supply. When you are designing the antenna system, check the voltage and current requirements of the components to insure compatibility.

The location of the booster amplifier is important. It needs to be before the second length of cable, shown in the simplified GNSS antenna and cable block diagram.

If the booster amplifier is placed just *before* the instrument, then the signal has been attenuated too far and the output might be noisy. If you cannot put the optional booster amplifier in the middle of a long run of cable, then put it near the antenna rather than near the instrument end.

For more complex systems, a variety of booster amplifiers, powered and passive splitters, DC blocks, and filters are available from a number of vendors.

System Operation

This section describes the basic operation of the SPG9000. This includes descriptions of the front panel of the SPG9000 and how to move through the on-screen menus. There are also details of how to use the web interface: how to log in, information in the tabs, and how to understand the available information. This section also explains how to control the instrument through the application programming interfaces (APIs) and the general purpose interface (GPI). Finally this section explains how to create, save, and recall presets.

Front-Panel Interface

This section provides information about operating the instrument using the front-panel buttons and display. These menus and selections are similar to those on the web interface.

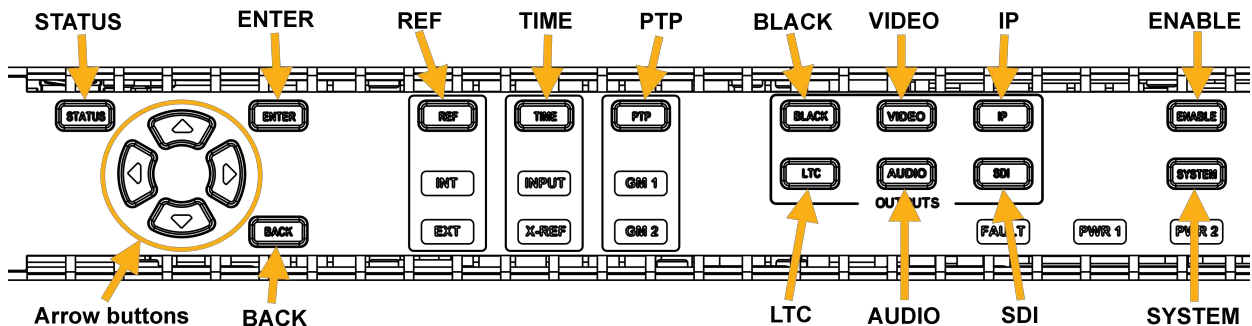

Front-Panel Layout

The SPG9000 front panel includes a color display for configuration menus and status messages, and a set of buttons for accessing and navigating these menus.

STATUS: Press to view the current status of the instrument, such as the state of the reference source, time-of-day, GNSS signal, and PTP instances. See [System Status and Monitoring](#).

ENTER: Press to accept the selected option.

Arrow buttons: Use the \triangle (up) and ∇ (down) buttons to scroll through the list of available menus, use the \triangleleft (left), and \triangleright (right) buttons to view the list of available options for the current menu.

BACK: Press to return to a previous menu or exit Edit Mode.

REF: Press to configure the reference source and GNSS receiver parameters. See [Reference and Time Sources](#).

TIME: Press to configure the time-of-day source and options for daylight saving time, leap second, and daily jam sync management. See [Reference and Time Sources](#).

PTP: Press to configure the two PTP instances. See [PTP Operation](#).

BLACK: Press to configure the six black outputs. See [Black Outputs](#).

LTC: Press to configure the four LTC outputs (or one input and three outputs). See [Linear Time Code Input and Outputs](#).

VIDEO: Press to configure the four video sources. See [Video Sources](#).

AUDIO: Press to configure the audio sources (tone generators) or the audio reference outputs (Word Clock and DARS). See [Audio Sources](#) and [Audio Reference Outputs](#).

IP: Press to configure the IP (ST 2110) video, audio, and data streams for test signal generation. See [IP Streams](#).

SDI: Press to configure the four SDI outputs for test signal generation. See [SDI Outputs](#).

ENABLE: Press and hold to enable and disable the front-panel interface. See [Front Panel Disable and Enable](#).

SYSTEM: Press to configure systemwide parameters such as presets, network interfaces, passwords, and power supplies. See [Presets](#), [Management Network Interface](#), and [System Maintenance](#).

Front Panel Disable and Enable

Access to the front-panel interface can be configured to end after a period of idle time. See [Front-Panel Settings](#).

Disable Front-panel Interface

Press-and-hold **ENABLE** for 2 seconds. The display backlight is dimmer when the interface is disabled. When the front-panel interface is disabled, pressing any front-panel button does not have an effect, except the **ENABLE** button is illuminated as a reminder that the front panel is currently disabled.

Enable Front-panel Interface

Press-and-hold **ENABLE** for 4-5 seconds. The display backlight is brighter when the interface is enabled.

Menu System

The SPG9000 front-panel interface is organized as a set of menus. Each of the front-panel menu buttons is associated with one of the menu lists. For example, press the **REF** button to open the **REFERENCE** menu list. The top line of the display shows the name of

the current menu in its hierarchical structure. For example, the REFERENCE : GENLOCK : TIMING menu is a third-level menu under the REFERENCE menu list.

1. Press **REF** to open the REFERENCE menu.
2. Press the \triangle or ∇ button to move between menus.

Note: Menus are organized in a circular structure; if you press the same arrow repeatedly, you will view all available menus and return to your original starting menu.

3. When the REFERENCE : GENLOCK menu is displayed, press ENTER.
4. Repeat the process to find the TIMING submenu, and press ENTER.

Some buttons are associated with multiple outputs or ports. Press a menu button repeatedly to cycle through the menus for each of the outputs. For example, press the LTC button to cycle through the four menus for LTC 1 through LTC 4. Within any of these menus, press the \triangle or ∇ button to cycle through the complete set of menus for that output. The LTC 1 menu has six submenus: MODE, FORMAT, SOURCE, OFFSET, DELAY, and OUTPUT LEVEL. The list of submenus is circular, meaning you can go directly from the first submenu (in this example MODE) to the last submenu (in this example OUTPUT LEVEL) by pressing the \triangle button, or from the last submenu to the first by pressing the ∇ button.

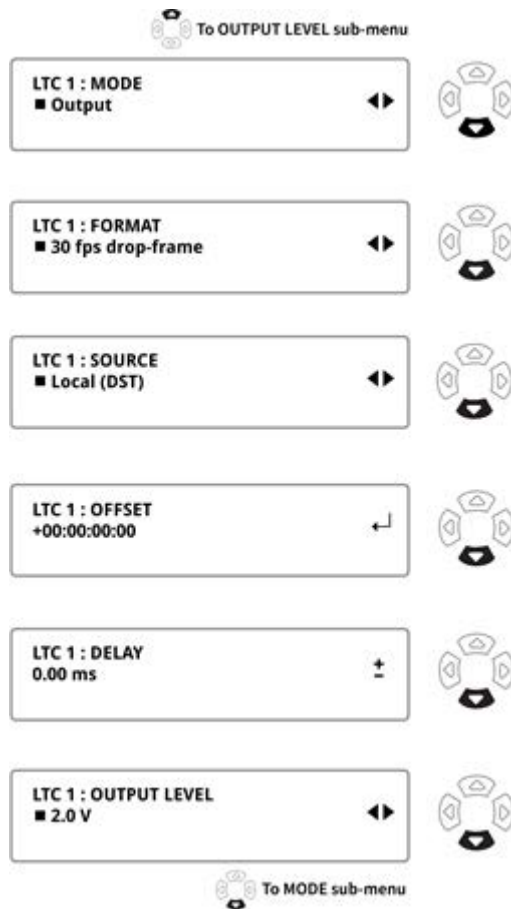

Note: Menus might be hidden if they are not applicable or available in the current configuration settings. In this example, the MODE submenu is only available for LTC 1 because only LTC 1 can be configured as an input or as an output. When it is configured as an input, the other five submenus (FORMAT through OUTPUT LEVEL) are hidden because they are only applicable for LTC outputs.

Menu Operations

There are four kinds of menus used for making configuration changes and for viewing the instrument status. Each menu type is indicated by a symbol displayed on the right side of the second menu line.

Note: In all menus, except in edit mode, the up and down arrows change the selected menu.

Selection Menus

Selection menus are marked by the pair of left- and right-facing triangles on the right, as shown in the example.



Use selection menus to choose one option from an available list. When the menu first opens, the current setting is indicated by a square bullet symbol to the left of the item.

1. Press the ◀ or ▶ button to cycle through the available options.
2. When the required option is displayed, press **ENTER**. The menu text blinks to confirm the selection and the bullet indicates the new selection.

Adjustment Menus

Adjustment menus are marked by a plus-minus sign on the right, as shown in the example.



Use these menus to make immediate adjustments to the configuration parameters.

- Press ▶ to *increase* the parameter by the smallest increment available (for example, 0.0185μs).

- Press ◀ to *decrease* the parameter by the smallest increment available.
- Press-and-hold ◀ or ▶ to increase or decrease the parameter until the button is released.
- Press both ◀ and ▶ at the same time to return the parameter to the default value.

Edit Menu

Edit menus are marked by the carriage-return symbol, as shown in the example.



Use these menus to change editable strings like passwords, IP addresses, and parameters with multiple fields. Edit menus are modal, which means the arrow buttons have different behaviors when the menu is in edit mode from when the menu is in navigation mode.

1. Press ENTER to switch the menu to edit mode, confirmed by an underline under the first editable character, digit, or field.

Note: When in edit mode, you must press ENTER or BACK to leave.

2. Press the ◀ or ▶ button to change to the next or previous editable character, digit, or field.
3. Press the △ or ▽ button to move through the available values for the character, digit, or field. For example, when editing an IP address, press the △ or ▽ button to cycle through the numeric digits 0-9.
4. When you have set the value for a character, digit, or field, press the ▶ button to move to the next item and repeat.
5. When all changes have been made, exit edit mode:
 - To exit edit mode and *accept* the currently displayed values, press ENTER.
 - To exit edit mode and *cancel* the editing changes, press BACK.

Multiple-Page Menu

Multiple-page menus are used to display read-only status information, not for making configuration changes. These menus are marked by a pair of arrows, facing opposite directions, as shown in the example.



The arrows mark indicate that there is more information to be viewed by pressing the left or right arrow buttons.

Press ◀ or ▶ repeatedly to move though all available pages of information.

Front-Panel Settings

There are several settings to change the appearance and behavior of the front-panel interface. These settings may only be changed from the front panel itself; you cannot change these settings remotely from the web interface or the web services API. They are not saved in preset files, but some settings are saved in the non-volatile memory of the instrument so they are preserved when the system cycles power.

The table summarizes the menu structure that is accessed when you press the SYSTEM button. Indentation indicates the menu hierarchy; for example, you need to access the SYSTEM : FRONT PANEL submenus to configure the front-panel settings. Other SYSTEM menus are shown collapsed and with dim highlighting to show their position in the menu list. For example, when you press the SYSTEM button, the first menu to be displayed is SYSTEM : PRESET. Press the down arrow button three times to go to the SYSTEM : FRONT PANEL menu. Press ENTER to go to the SYSTEM : FRONT PANEL : TIMEOUT menu. Press the up or down arrow buttons to cycle between the three submenus (TIMEOUT, DISP BACKLIGHT, and BEEPER).

Menu lists like this are used in other sections of this document to help you move through the front-panel menu system. See [Menu Operations](#).

The sample table shows the submenus for the SYSTEM menu and the submenu FRONT PANEL.

SYSTEM :

PRESET :

INFO :

NETWORK :

FRONT PANEL :

TIMEOUT

DISP BACKLIGHT

BEEPER

WEB :

GENERAL PURPOSE INTERFACE :

POWER SUPPLY :

FIRMWARE UPGRADE

CALIBRATE OVEN

DIAGNOSTICS

TIMEOUT

Select the idle time period before the front-panel buttons are disabled. This feature can be used to prevent accidental configuration changes. An operator must explicitly re-enable the front-panel interface to access any menus.

Select **Disable** if you never want the front-panel interface to time out. See [Front Panel Disable and Enable](#).



CAUTION: We strongly recommend using the timeout function to keep the display backlight at a low level when the front-panel interface is not actively being used, to maximize the life of the display backlight.

DISP BACKLIGHT

Select the brightness of the backlight for the front-panel LCD. The display brightness can be adjusted from a value of 1 (dim) to 8 (bright). When the front-panel interface is disabled, the display backlight brightness changes to the dimmest value (1) until it is re-enabled and the selected brightness is restored.

BEEPER

Select **ENABLE** to permit the internal beeper to sound. The beeper emits a short chirping sound every second when there is a hardware fault. See [FAULT](#).

This setting is not saved in non-volatile memory. If the beeper is disabled, it re-enables when power is cycled. This ensures that the hardware fault alarm is not unintentionally ignored.

Management Network Interface

The instrument has a 10/100/1000 BASE-T Ethernet port on the rear panel that is used for management functions. You can remotely control the instrument through the web interface or through the application programming interfaces (APIs), and system events can be logged to a remote server from the management interface.

This section provides instructions for configuring the network parameters of the management network interface.

Note: The management port can only be configured using the front-panel user interface.

Front-Panel Menu for NETWORK

To use the front panel of the SPG9000 for this process, press **SYSTEM** and then select the **NETWORK** option. See [Menu Operations](#) for details of using the front-panel menus.

The table shows the submenus for the NETWORK menu.

SYSTEM :	
PRESET :	
INFO :	
NETWORK :	
MGMT :	
DHCP	
IP ADDRESS	
SUBNET MASK	
GATEWAY	
MAC ADDRESS	
DNS SERVER	
HOSTNAME	
DOMAIN NAME	
SYSTEM NAME	
LOCATION	
PTP 1 :	Requires SPG9000-PTP license to be enabled
PTP 2 :	Requires SPG9000-PTP license to be enabled
IP 1 :	Requires SPG9000-IP license to be enabled
IP 2 :	Requires SPG9000-IP license to be enabled
FRONT PANEL :	
WEB :	
GENERAL PURPOSE INTERFACE :	
POWER SUPPLY :	
FIRMWARE UPGRADE	
CALIBRATE OVEN	
DIAGNOSTICS	

Configuration Settings for NETWORK

The NETWORK settings are used to configure all the Ethernet ports for the SPG9000, including the management interface, the PTP ports, and the IP ports.

MGMT

The MGMT submenu includes all the configuration settings for the management network interface.

DHCP

Select **ENABLE** to use Dynamic Host Configuration Protocol (DHCP) on the management interface. In this case, a DHCP server must be present on the network, and it assigns the IPv4 address, subnet mask, and gateway address. If you enable DHCP,

manual configuration of those values is disabled but the values provided by the DHCP server are displayed.

IP ADDRESS

Enter the four octets of the IPv4 address, in dotted decimal notation. An edit menu (see [Edit Menus](#)) is used to enter the address, with three digits for each octet with leading zeros if necessary. For example, an address of 192.168.1.50 would appear as 192.168.001.050 in this menu. If DHCP is enabled, the IPv4 address supplied by the DHCP server is displayed instead and cannot be edited.

SUBNET MASK

Enter the four octets of the subnet mask, in dotted decimal notation. If DHCP is enabled, the subnet mask supplied by the DHCP server is displayed instead and cannot be edited.

GATEWAY

Enter the four octets of the gateway address for this subnet, in dotted decimal notation. If DHCP is enabled, the gateway address supplied by the DHCP server is displayed instead and cannot be edited.

MAC ADDRESS

This is a read-only menu that displays the physical (MAC) address of the management port. The first three octets of a MAC address indicate an Organizationally Unique Identifier (OUI), to help identify equipment on the network. The OUI for Telestream is 00-90-56, so the MAC addresses always begin with these three octets.

DNS SERVER

Enter the four octets of the Domain Name System (DNS) server address, in dotted decimal notation. The DNS server is used to resolve hostnames into IPv4 addresses so a hostname can be specified for SPG9000 configuration parameters such as a remote NTP server (see [Network Time Protocol](#)), a syslog server (see [Syslog](#)), or an SNMP trap destination (see [SNMP](#)). You can specify a DNS server in your local network, or a public server such as Google Public DNS (8.8.8.8) or Cloudflare (1.1.1.1). If DHCP is enabled, the DNS server address supplied by the DHCP server is displayed instead and cannot be edited.

Note: In the front-panel interface, use 3 digits for each number in the octet, such as 008.008.008.008 or 001.001.001.001.

HOSTNAME

Enter the hostname portion of the fully qualified domain name (FQDN) for the instrument. This name can be used to access the instrument instead of using its IP address. Valid characters for the hostname include alphanumeric characters (A-Z, a-z, and 0-9) and the hyphen character. The first character must be a letter or numeral.

The factory default hostname is “spg9000-s000000” where the last six digits represent the numeric portion of the device's serial number. The serial number is on a sticker on the left side of the SPG9000 and appears on a label on the packaging box.

DOMAIN NAME

Enter the domain name portion of the FQDN. Valid characters for the domain name include alphanumeric characters (A-Z, a-z, and 0-9), the hyphen character, and the “dot” character (to separate levels in the domain hierarchy). The first character must be a letter or numeral. If DHCP is enabled, the domain name supplied by the DHCP server is displayed instead and cannot be edited.

Note: The factory default domain name is “telestream.net”, so this must be changed to your local domain name.

Note: If you wish to use multicast DNS (mDNS) for NMOS Discovery, use a domain name of “local”. See [NMOS API](#).

SYSTEM NAME

Enter a name to identify this system for management protocol purposes. The system name that you choose will be used in several places:

- As the “label” for the /self and /devices objects in the IS-04 Node API. This label is commonly visible in NMOS controller applications, so you can uniquely identify each SPG9000 that is registered and using NMOS. See [NMOS API](#).
- As part of the sysDescr object in the SNMP Management Information Base (MIB). See [SNMP](#).
- As the first part of the userDescription parameter in the PTP descriptionDS data set. This value can be read via PTP management messages and by the /ptp/{instance}/description-ds endpoint in the HTTP API. See [HTTP API](#).
- As part of the System Description advertised via Link Layer Discovery Protocol (LLDP) for the two PTP ports and the two IP ports.

LOCATION

Enter a string to describe the physical location of this system for management protocol purposes. The location you choose will be used in two places:

- As the sysLocation object in the SNMP MIB. See [SNMP](#).
- As the second part of the userDescription parameter in the PTP descriptionDS data set. This value can be read via PTP management messages and by the /ptp/{instance}/description-ds endpoint in the HTTP API. See [HTTP API](#).

Web Interface for Management Network Interface

After the management network interface has been configured, its status can be viewed from the web interface. Click on the **System** tab and select **System Information**. The values are displayed in a section at the top right of the section.

The Host Name, System Name, and Location values can be edited from the web interface. If a static IP address is used, the Domain and DNS Server values can also be edited. If DHCP is used, the Domain and DNS Server values are read-only, as they are provided from the DHCP server. The MAC Address, IP Address, Subnet Mask, and Gateway values are always read-only status values from the web interface. The IP Address, Subnet Mask and Gateway values can only be changed from the front-panel interface.

The screenshot shows a configuration window titled "Management Interface" with the following fields and values:

Host Name	spg9000-s010110
Domain	telestream.net
MAC Address	20-d7-78-13-1f-f2
IP Address	10.101.3.224
Subnet Mask	255.255.255.0
Gateway	10.101.3.1
DNS Server	10.101.2.5
System Name	B50 Primary
Location	B50 R02 S23

Web User Interface

After the management network interface has been configured, the SPG9000 can be accessed through a web-based user interface, using any modern browser. The default URL is:

`http://hostname`

where *hostname* is replaced with a fully qualified domain name of the SPG9000, or:

`http://ip_address`

where *ip_address* is replaced with the IP address of the management network interface.

Operational Considerations

We recommend a maximum of four simultaneous users be connected to the instrument that is using the web interface. If more users are connected, it can result in lower performance and inconsistent behavior.

Note: The web interface requires that JavaScript be enabled.

Web Interface for User Login and Access Control

When the web interface URL first opens, there is a login page. The SPG9000 has two built-in user accounts for web interface access: “admin” and “operator.” These accounts are case sensitive and cannot be renamed.

- admin: has full read-write control for all system settings.
- operator: has a read-only view of the instrument; the web interface shows status information but configuration settings cannot be changed.



The default password for the admin account is “admin” and the default password for the operator account is “operator”. We recommend you change these passwords to a unique value for each instrument. You can change both passwords from the SYSTEM : WEB : ADMIN PASSWORD and SYSTEM : WEB : OPERATOR PASSWORD menus on the front-panel interface. You can also change the currently logged-in user’s password through the web interface, on the System tab, in the Management Settings section.

Front-Panel Menu for WEB

To use the front panel of the SPG9000 for this process, press **SYSTEM** and then select the **WEB** option. See [Menu Operations](#) for details of using the front-panel menus.

The table shows the submenus for the WEB menu.

SYSTEM :
PRESET :
INFO :
NETWORK :
FRONT PANEL :
WEB :
ADMIN PASSWORD

SYSTEM :

OPERATOR PASSWORD

API KEY

GENERAL PURPOSE INTERFACE :

POWER SUPPLY :

FIRMWARE UPGRADE

CALIBRATE OVEN

DIAGNOSTICS

ADMIN PASSWORD

View or update the password for the “admin” account. It has full read-and-write access to instrument settings.

OPERATOR PASSWORD

View or update the password for the “operator” account. It has read-only access to instrument settings.

API KEY

View or update the API key for authentication of HTTP API messages. See [HTTP API](#).

Elements of Web User Interface

The web interface for the SPG9000 is a single-page application that dynamically updates based on current configuration and system state. The top banner (with a blue

background) is always present, but the main page body (with a white background) depends on user navigation.

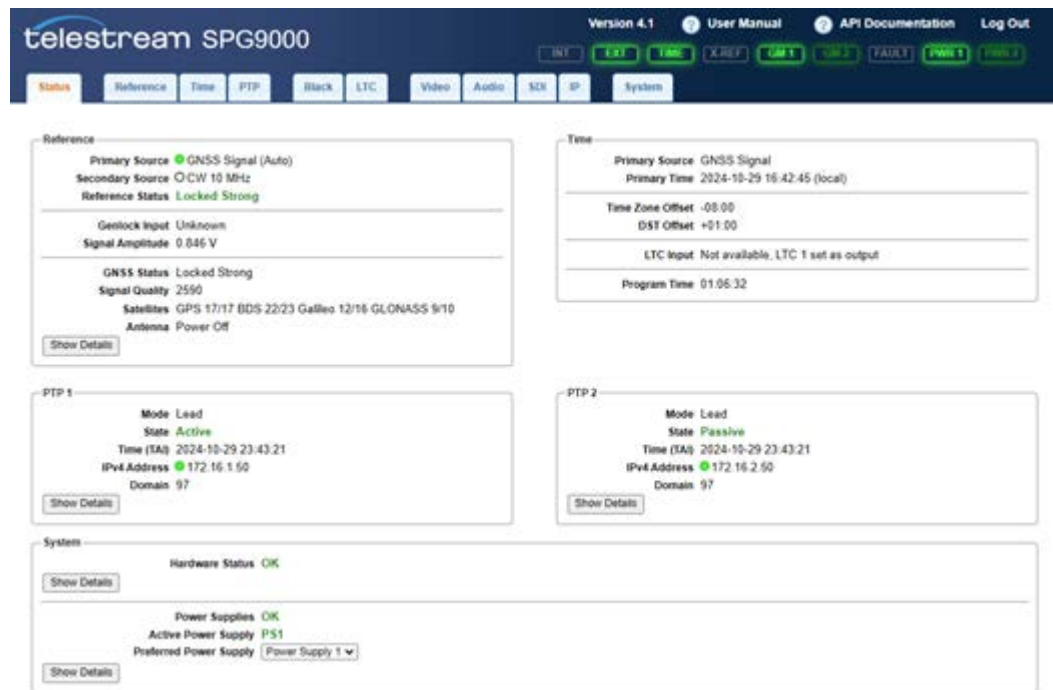

Menu tabs

The name of each tab corresponds to a specific button on the front panel, and items on the tab are similar to the front-panel menu system; see [Front-Panel Interface](#). On the web page, select the tab to go to that item and see its menus.

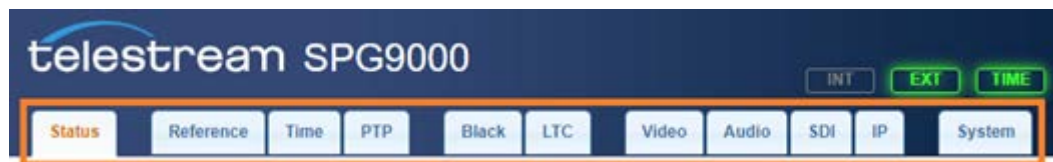

Status

Select to observe the current operational status of the instrument and manage the power supply modules. See [System Status and Monitoring](#) and [Power Supply Monitoring and Replacement](#).

Reference

Select to configure the current reference source (genlock input, GNSS signal, PTP follower, or internal) and to configure the GNSS receiver (option SPG9000-GNSS required). See [Reference and Time Sources](#).

Time

Select to configure the time of day source (including any time zone offset), daylight saving time parameters, leap second adjustments, daily jam sync schedule, and program time. See [Reference and Time Sources](#).

PTP

Select to configure the two PTP instances associated with the two SFP ports, labeled PTP 1 and PTP 2. This tab is not present unless the SPG9000-PTP option is licensed. See [PTP Operation](#).

Black

Select to review and configure the six analog sync signal outputs. These are labeled BLACK 1 through BLACK 6. See [Black Outputs](#).

LTC

Select to configure the four linear time code (LTC) outputs, or three outputs and one input. See [Linear Time Code Input and Outputs](#).

Video

Select to review and configure the video sources (test patterns or images) that are used for SDI and IP test signal outputs. See [Video Sources](#).

Audio

Select to review and configure the audio sources (32 tone generators) or the audio reference outputs (Word Clock and DARS). See [Audio Sources](#) and [Audio Reference Outputs](#).

SDI

Select to review and configure the four SDI outputs. These are labeled SDI 1 through SDI 4. See [SDI Outputs](#).

IP

Select to review and configure the ST 2110 video, audio, and data streams for the two IP ports. See [IP Streams](#).

System

Select to manage several systemwide settings:

- Save and recall presets: see [Presets](#).
- Upload, download, rename, or delete user-created files: See [File Management](#).
- View the hardware and software versions: see [Check Current Firmware Version](#).
- View and configure the management interface: See [Management Network Interface](#).
- Update option licenses: see [Licensed Features](#).

- Configure the web server, including security and authentication: see [Secure Web Interface](#).
- Configure system logging: see [Syslog](#).
- Configure the Simple Network Management Protocol agent: see [SNMP](#).
- Configure the Networked Media Open Specifications (NMOS) interface. See [NMOS API](#).
- Configure the network interfaces for the SFP ports: see [Configuration Settings for PTP Network Interfaces](#) and [Configuration Settings for IP Network Interfaces](#).
- Configure the general purpose interface inputs and outputs: see [General Purpose Interface](#).

LED Indicators

The indicators are the same as those on the front of the instrument. See [Indicators](#).

User Manual

Select to open the PDF file of this User Manual document. The file is stored on the instrument, so it can be viewed even when the SPG9000 is not connected to the public Internet via the management network.

API Documentation

Select to open the SPG9000 HTTP API web page. See [HTTP API](#).

Secure Web Interface

The SPG9000 integrated web server can use HTTPS instead of HTTP to provide a secure web interface. This might be required by your organization cybersecurity requirements, such as EBU R 143.

The factory configuration for the web interface is to use HTTP but you can install your organization certificate files and use HTTPS.

Most browsers show the site status and protocols. For example, with plain HTTP, the Chrome browser indicates the SPG9000 web interface is “Not secure”:

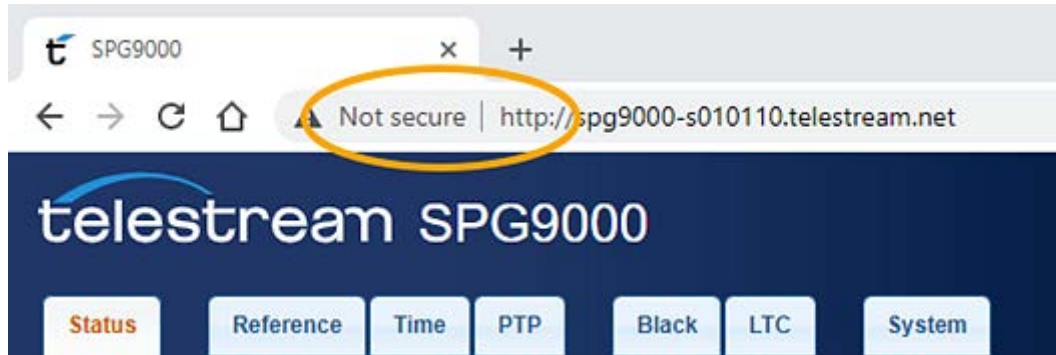

Configure Web Server

To install new SSL certificate files and switch to HTTPS,

1. Select the **System** tab and then select **Management Settings**.
2. Go to the Web Server subsection.

Web Server

Web Page Password	View	Change
API Key	View	Change

Web Server Protocol	HTTP (Port 80)	▼
SSL Certificate	Choose File	No file chosen
SSL Certificate Key	Choose File	No file chosen
SSL Password File	Choose File	No file chosen

Two or three files are needed to complete the installation. Your IT organization should provide the files for your domain. Use the web interface to select these files from a location on a local computer.

SSL Certificate: Choose the certificates file. This file should contain the PEM format certificate chain for the server, any intermediate certificates, and the CA certificate. The certificate chain can be of any length, although most will contain two or three certificates. The first certificate in the file should be the server certificate that corresponds to the SSL Certificate Key file. The SSL Certificate file should have a filename extension of .crt.

SSL Certificate Key: Choose the private key file. The private key should correspond to the first certificate in the SSL Certificate file. This file should use the PEM format and have a filename extension of .key.

SSL Password File: Choose the password file. This file is optional and only needed if the key file uses passphrases. The password file should have a filename extension of .txt.

3. When the certificate, key, and optional password files have been selected, click **Install Certificate** to upload the files to the SPG9000.
4. If the certificate files are installed successfully, select **HTTPS (Port 443)** from the Web Server Protocol menu and click **Restart Web Server**. After the web server restarts, the web page shows as secure.

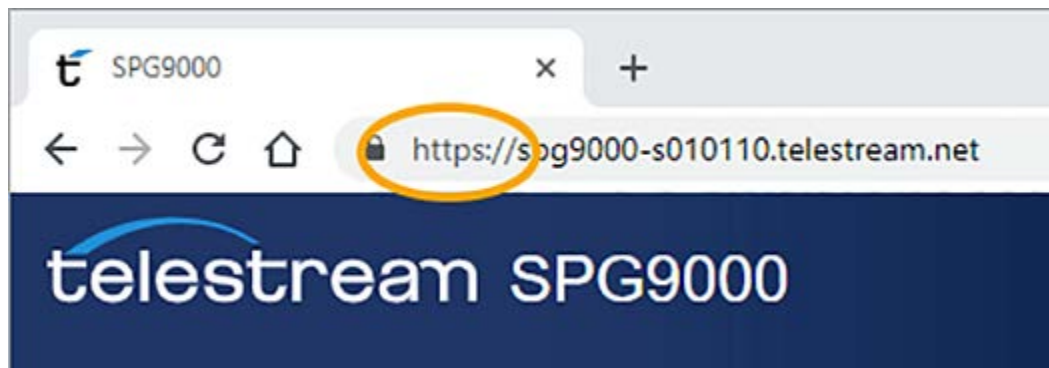

Note: If you change the configuration from HTTPS back to HTTP, you may need to force a hard refresh of your browser.

Application Programming Interfaces

The SPG9000 has multiple application programming interfaces (APIs) for remote access to the instrument. Client-side applications, such as data visualization dashboards, can use the APIs for system management and monitoring.

HTTP API

The primary API for the SPG9000 is based on Hypertext Transfer Protocol (HTTP) messages with JavaScript Object Notation (JSON) text. This API style is commonly referred to as a REST (Representational State Transfer) API. Strictly speaking, the SPG9000 API is not RESTful, but the message formats are familiar to developers with REST API experience.

Messages and Endpoints

The SPG9000 HTTP API uses three HTTP message types:

GET: Used to read status and/or configuration information from the SPG9000. The GET message sent to the SPG9000 does not have a message body, but the normal response from the SPG9000 (200 OK) includes a JSON object (content-type: application/json) including the requested values.

PUT: Used to set configuration parameters. The message body for the PUT message must be a JSON object with the parameter to be updated. The SPG9000 accepts a partial JSON object for PUT messages, so a subset of configuration parameters can be changed while keeping other parameters unchanged.

POST: Used to command the SPG9000 to perform an internal operation.

Endpoints are described in the documentation with a path such as “/system/status” that corresponds to a complete URL:

`http://spg9000/api/v1.0/system/status`

where *spg9000* is the hostname or the IP address of the system. The prefix */api/v1.0* is required for every endpoint.

Note: If the SPG9000 web server has been configured to use HTTPS with an SSL certificate (see [Secure Web Interface](#)), the API URL uses the protocol *https://*.

Authentication

The SPG9000 HTTP API requires all messages to be authenticated, similar to requiring a user to log in with a password for the web interface. The header field *X-API-Key* must be included in every HTTP request sent to the SPG9000. If this header field is missing or does not match the user-configurable key value, the SPG9000 returns a response message: 401 Unauthorized.

The factory default value for the API key is “apikey”. This value can be changed from the web interface, on the System tab, in the Management Settings section. The API value can also be changed through the front panel in the SYSTEM : WEB : API KEY menu.

Note: You must be logged in as the admin user to view or change the API key.

The screenshot shows a configuration window titled "Web Server". It contains two rows of settings. The first row is for "Web Page Password", with a text input field containing six asterisks, and two buttons labeled "View" and "Change". The second row is for "API Key", with a text input field containing six asterisks, and two buttons labeled "View" and "Change".

Note: We recommend you change this value to a strong password, and do not share the key outside your organization.

API Documentation

Documentation for the HTTP API is available in the SPG9000 web interface. In the top banner, select **API Documentation**.

A new browser window appears for the documentation page.



The complete set of available messages is organized into categories on the documentation page:

Presets: Messages with an endpoint starting with /configuration are used to manage the configuration settings for any part of the entire instrument. See [Presets](#).

System-Wide Configuration and Status: Messages with an endpoint starting with /system correspond to configuration settings on the web interface, on the System tab, or in the front-panel SYSTEM menu. The messages also correspond to status information found on the Status tab or STATUS menu.

Reference and Time: Messages with an endpoint starting with /reference are used to manage the configuration settings of the frequency and time reference sources of the instrument, and to get the current status of all available reference sources.

PTP: Messages with an endpoint starting with /ptp are used to manage the two PTP instances corresponding to the PTP 1 and PTP 2 ports. The option SPG9000-PTP is required for this feature. The /ptp messages in the API are directly based on the SMPTE RP 2059-15 YANG data model for PTP.

GNSS: Messages with an endpoint starting with /gnss are used to configure the GNSS receiver and to get current status information about the received signals. The option SPG9000-GNSS is required for this optional feature. Some of these messages are based on the RP 2059-15 YANG data model.

SMPTE RP 2059-15: Endpoints starting with /ptp-smpte, /grandmaster, or /rfc-8173 are based on the RP 2059-15 YANG data model. They are used to access additional information not present in any of the /ptp endpoints, such as values specific to the ST 2059-2 PTP profile.

Black Outputs: Endpoints starting with /blacks are used to manage the configuration settings of the 6 analog sync (BLACK) outputs. See [Black Outputs](#).

LTC Outputs: Messages with an endpoint starting with /ltc are used to manage the configuration settings of the 4 Linear Time Code (LTC) outputs (or 3 outputs plus 1 input). See [Linear Time Code Input and Outputs](#).

Video Sources: Endpoints starting with /video are used to manage the configuration settings of the 6 video sources used for test signal generation over the SDI and IP interfaces. See [Video Sources](#).

Audio Sources: Endpoints starting with /audio are used to manage the configuration settings of the audio tones used for test signal generation over the SDI and IP interfaces. They also manage the configuration settings of the audio reference outputs (Word Clock and DARS). See [Audio Sources](#) and [Audio Reference Outputs](#).

SDI Outputs: Endpoints starting with /sdi are used to manage the configuration settings of the 4 SDI outputs. See [SDI Outputs](#).

IP Streams: Endpoints starting with /ip are used to manage the configuration settings of the ST 2110 video, audio, and data streams. See [IP Streams](#).

To view the details for a particular message, select the message name to open a panel with example values and schema descriptions for the response body (GET messages) and request body (PUT messages).

You can use the documentation to interactively send HTTP API messages to the SPG9000 without requiring the use of external software:

1. Select **Authorize** at the top of the page and enter the API key.
2. Select **Try it out**.
3. You might have to enter a parameter for the URL; for example, for the GET /blacks/{output} message enter an output number to create the complete endpoint (that is, /blacks/1 for the BLACK 1 output).
4. For PUT messages, you also need to edit the JSON message body, starting with the example provided.
5. Select **Execute** to send the message to the SPG9000. The Responses section shows the request and the server response.

NMOS API

The SPG9000 supports some of the NMOS (Networked Media Open Specifications) APIs, developed by the Advanced Media Workflow Association (AMWA). Specifically, the SPG9000 supports:

- IS-04 Discovery and Registration
- IS-05 Device Connection Management

Per the NMOS model, the SPG9000 registers as a node with a single device. This device contains 18 senders, each corresponding to an IP stream configured for one or both IP ports.

- 6 video senders
- 6 audio senders

- 6 data senders

When the SPG9000 node is registered, it can be used as the source for ST 2110 IP streams. Typically you use an external NMOS connection manager application to make the connections from senders to receivers. If the connection manager is used to specify the desired multicast destination address and UDP port numbers, it will “patch” those values to the SPG9000 using IS-05 API methods. Any previously configured addresses and port numbers will be updated.

Note: See [IP Streams](#) for more information about configuring ST 2110 video, audio and data streams.

Note: The SPG9000-IP license must be enabled to configure and use the NMOS API.

Web Interface for NMOS

1. In the SPG9000 web interface, select the **System** tab.
2. Select the **Management Settings** and find the **NMOS** section.
3. Make the necessary changes to the parameters.
4. Select **Apply Changes** for the settings to take effect.

Configuration Settings for NMOS

The NMOS settings are used to control the registration of the SPG9000 node.

NMOS Services

Select this box to enable NMOS. If disabled, the SPG9000 will not register its services and will not respond to connection requests,

Browse APIs

Click this link to view the responses from GET requests to NMOS API endpoints, starting with `http://<hostname>/x-nmos`. When NMOS is enabled, you can query the node and connection resources. If NMOS is disabled, the web server will respond with a 502 Bad Gateway error message.

Note: If the web server of the SPG9000 is configured to use HTTPS with port 443, the NMOS API will continue to use HTTP with port 80. See [Secure Web Interface](#).

Discovery

Select the method for the SPG9000 node to discover the registry server.

Automatic discovery will use the DNS-SD and mDNS protocols, as described in IS-04. If the system domain name is “local”, mDNS will be used. If the system domain name is anything else, DNS-SD will be used, using the DNS server address that is configured manually or set via DHCP. See [Configuration Settings for NETWORK](#).

If the local DNS server has not been configured with the necessary records for NMOS, you can use Manual discovery mode. Enter the IP address or hostname of the NMOS registry server. If the NMOS registry server uses a different port number than the standard HTTP port 80, you can append a colon and port number after the IP address or hostname, such as “10.1.2.3:5000”.

Registry Server

Displays the IP address and port number of the current registry server, or “Not Registered” if the SPG9000 has not yet successfully completed the discovery and registration process.

Syslog

The SPG9000 uses the standard syslog function to record log messages about system status and events. Syslog messages can be directed to a remote server using the management network interface, or they can be stored to volatile storage on the SPG9000 and later downloaded to your computer. The SPG9000 uses volatile storage for local syslog files to extend the life of the non-volatile memory storage.

The SPG9000 can store up to 50 MB of syslog messages in local storage. These are saved in files of up to 10 MB each. The most recent syslog file is named “syslog.txt” and when it reaches 10 MB in size, it is moved to “syslog1.txt” and a new “syslog.txt” file is created for subsequent messages. Any existing “syslog1.txt” file is moved to “syslog2.txt”, and so on. Therefore, there will be a maximum of five syslog files saved in volatile memory: “syslog.txt” (newest) to “syslog4.txt” (oldest).

It is strongly recommended to periodically download older syslog files to your computer before they are removed, or use the remote syslog server function to continuously save log messages. When the SPG9000 is powered down, all syslog files in volatile storage will be lost. To download log files from the SPG9000 to your computer, use the File Manager from the web interface. See [File Management](#).

Syslog uses a set of predefined facility codes to identify the event source. For example, events related to security or authentication use the “auth” facility and events related to the Linux kernel use the “kern” facility. Messages related to SPG9000 software (including the PTP processes) use the “user” facility.

Syslog has eight defined severity levels. You can configure the threshold for reporting events. For example, setting a threshold of Warning means that any Notice, Informational, and Debug messages are not logged.

Severity Level	Description
Emergency	The system is unusable
Alert	Action must be taken immediately
Critical	Critical conditions
Error	Error conditions
Warning	Warning conditions
Notice	Normal but significant conditions
Informational	Informational messages
Debug	Debug-level messages

Most messages logged by the SPG9000 use the Informational, Notice, Warning, or Error severity levels.

Web Interface for System Logging

1. In the SPG9000 web interface, select the **System** tab.
2. Select the **Management Settings** and find the **System Logging** section.
3. Make the necessary changes to the parameters.
4. Select **Apply Changes** for the settings to take effect.

Configuration Settings for System Logging

The System Logging settings are used to configure the connection to the remote syslog server if enabled and set the conditions for what messages to store.

Log to Remote Server

Select this box to enable remote logging. By default, remote logging is disabled, but logging to local storage is always enabled.

Syslog Server

Enter the IP address or host name of the remote server(s). If you configure a second (backup) server, the same syslog messages will be sent to both destinations. If you only use one syslog server, leave the second text box empty; do not use an IP address of 0.0.0.0. Be sure that any firewall on the remote computer is configured to permit syslog traffic to be received.

Transport Protocol

You can select UDP (port 514) or TCP (port 6514) for sending messages to the remote server. The default is UDP, because it is a lightweight connectionless protocol with little overhead. Select TCP for connection-oriented message transmission to the server.

Minimum Severity

You can select the minimum threshold for saved syslog messages. Messages with a lower severity level will be discarded. You can select independent thresholds for the remote syslog server and for local storage. The default value is Warning, which means that only Error and Warning level messages would typically be logged. Severity levels of Emergency, Alert, and Critical are unlikely to be observed, but they would be logged.

Message Format

Syslog messages are plain text but follow a specific format. In this example:

```
<13>Mar 16 12:34:56 spg9000-s012345 SPG9000[820]: Primary reference source is now locked
```

the string is made up of five elements:

- The first field is the facility and severity level, "<13>" in this example. The decimal number between the < and > brackets can be converted to binary digits (such as 00001101), and the 5 most significant bits (00001) indicate the facility (in this case "user") and the 3 least significant bits (101) represent the severity level (in this case "notice"). Many syslog servers automatically decode <13> as "user.notice" to make logs easier to read.
- The second field is the date, "Mar 16 12:34:56" in this example. This time is always UTC, even if a time zone and daylight saving time offset have been configured.
- The third field is the hostname of the SPG9000, "spg9000-s012345" in this example. The syslog messages originating from the PTP processes use a modified hostname with an ending of "-2" (such as spg9000-s012345-2).
- The fourth field is the process name, "SPG9000[820]" in this example. Syslog messages from the PTP processes use a process name of "ptp4l" and messages from the main application use a process name of "SPG9000."

- The fifth and final field is the message body text, “Primary reference source is now locked” in this example.

SNMP

The SPG9000 supports the Simple Network Management Protocol (SNMP) for basic status reporting and notifications. You can query the instrument with Get, GetNext, or GetBulk request messages and you can change some system identification parameters with Set messages. You can also configure Trap messages to be sent to a network management system when the instrument has alert or fault conditions.

The SPG9000 supports its own Management Information Base (MIB) and the System group of objects from SNMPv2 MIB defined in RFC 3418. The objects in SPG9000-MIB are read-only objects that mirror the state of the indicators on the front-panel and web interface banner. See [Indicators](#).

MIB	Object Name	Description
SNMPv2 MIB	sysDescr	Identifies the SPG9000, including the firmware version, hostname, and system name. To change the system name, see Management Network Interface .
	sysObjectID	Object identifier (OID) of the Telestream SPG9000 (1.3.6.1.4.1.47445.1.1.2)
	sysUpTime	Time duration since the SNMP service was last started
	sysContact	Read/write object that indicates the contact person for this system. To change this value, send an SNMP Set message from a network management system.
	sysName	Hostname for this SPG9000. To change the hostname, see Management Network Interface .
	sysLocation	Read/write object that indicates the physical location of this system. To change the location, see Management Network Interface .

MIB	Object Name	Description
SPG9000-MIB	referenceStatus	Primary or secondary reference source status, corresponding to the EXT and INT indicators
	timeStatus	Time-of-day source status, corresponding to the TIME INPUT indicator.
	ptp1GMStatus ptp2GMStatus	PTP grandmaster status, corresponding to the GM 1 and GM 2 indicators
	hardwareStatus	Hardware status, corresponding to the FAULT indicator
	ps1Status ps2Status	Power supply status, corresponding to the PWR 1 and PWR 2 indicators
	referenceSource	Current reference source, primary or secondary

The SPG9000 uses SNMP version 3 (SNMPv3) because it includes higher security than previous versions, with stronger authentication and data encryption for privacy. The user-based security model (USM) is used for authentication and privacy. It has a single pre-defined username of "snmpv3user" that cannot be changed. The authentication credentials can be changed for this username to match the configuration on the network management system.

Web Interface for SNMP

1. In the SPG9000 web interface, select the **System** tab.
2. Select **Management Settings** and find the **SNMP** section.
3. Make the necessary changes to the parameters.
4. Select **Apply Changes** for the settings to take effect.

SNMP

SNMP Service Enable [Download SPG9000 MIB File](#)

Trap Messages Enable

Trap Destinations

Username

Authentication Type

Authentication Key

Privacy Type

Privacy Key

Configuration Settings for SNMP

The SNMP settings are used to configure the trap messages. This includes the type of trap messages and the authentication and privacy settings.

SNMP Service

Check this box to enable the SNMP service. If disabled, the instrument will not respond to received request messages and will not send Trap notification messages.

Download SPG9000 MIB File

Click on the link to download a copy of the “SPG9000.mib” file from your browser. This file can be imported into SNMP management applications so that they can use the names of SPG9000-specific objects instead of using their numeric Object Identifier (OID) values.

Trap Messages

Select this checkbox to enable Trap message notifications for certain system events. Fault, Error, or Warning Trap messages are repeated every 10 seconds while the condition persists, followed by a single Clear message when the condition is no longer present.

Trap messages correspond to the indicators on the front-panel and web interface banner. See [Indicators](#). Trap messages include a trapInfo object that contains additional text about the notification, and a timeOfDay object with the local time of day when the event occurred.

Trap Name	Description
hardwareFault	Any condition that causes the FAULT indicator to be on
hardwareFaultClear	The hardware fault condition has cleared and the FAULT indicator is off.
powerSupplyFault	Any condition that causes the PWR 1 or PWR 2 indicator to be red.
powerSupplyWarning	Any condition that causes the PWR 1 or PWR 2 indicator to be yellow
powerSupplyFaultClear	The power supply fault or warning condition has cleared and the PWR 1 and PWR 2 indicators are both off.
lockError	Any condition that causes the EXT indicator to be red
lockWarning	Any condition that causes the EXT indicator to be yellow
lockErrorClear	The lock error or warning condition has cleared and the EXT indicator is green, or the EXT indicator is off and the INT indicator is green.
timeError	Any condition that causes the (TIME) INPUT indicator to be red

Trap Name	Description
timeWarning	Any condition that causes the (TIME) INPUT indicator to be yellow
timeErrorClear	The time-of-day error or warning condition has cleared and the (TIME) INPUT indicator is green or off.
gnssSignalWarning	The GNSS signal level has dropped below the user-selected warning threshold. See Signal Warning Threshold .

Trap Destinations

Enter the IP address or hostname for one or two destination computers that will receive and log Trap messages sent from the SPG9000. Typically a network management system with SNMP support is configured with the IP address or hostname of the SPG9000.

Username

Displays the pre-defined username, "snmpv3user". The credentials for this user are saved on the SPG9000 and can be updated by changing the authentication values. The same username and credentials are configured on the external network management system, and the SPG9000 will only respond to requests when snmpv3user is authenticated successfully.

Authentication Type

Select the authentication protocol, either MD5 or SHA. Authentication ensures the identity of snmpv3user.

Authentication Key

Enter the key phrase for authentication. The string must be alphanumeric characters including spaces, with a minimum length of 8 characters and a maximum length of 32 characters.

Privacy Type

Select the privacy protocol, either AES (128-bit) or DES. The privacy protocol determines the method of encryption of SNMPv3 messages.

Privacy Key

Enter the key phrase for privacy (encryption). The string must be alphanumeric characters including spaces, with a minimum length of 8 characters and a maximum of 32 characters.

General Purpose Interface

The SPG9000 has a general purpose interface (GPI) with four inputs for commands to the instrument, and three outputs for alarm indications from the instrument.

There are two connectors on the back panel for the GPI. The 9-pin D-sub connector labeled "GPI" includes all four input pins and the three output pins. See [GPI Connector](#). The 15-pin, D-sub connector labeled "LTC/GPI" includes a subset of the GPI: one input and two outputs. See [LTC/GPI Connector](#). This connector can be used to connect the SPG9000 to the ECO9000 changeover unit so the two outputs can be used to signal the changeover.

Input and output signals are active low, with these characteristics:

Input	
High	Signal > 2.4 V or open (connected to internal 10 kΩ pull-up resistor)
Low	Signal < 0.8 V or ground (input impedance: 10 kΩ)
Pulse Duration	Ignores pulses < 40 ms and always detects pulses > 60 ms
Output	
Low	Signal < 0.4V or ground (when sinking 250 mA; maximum on-resistance 2 Ω)

Web Interface for General Purpose Interface

On the SPG9000 web interface, select the **System** tab and then select the **General Purpose Interface** section.

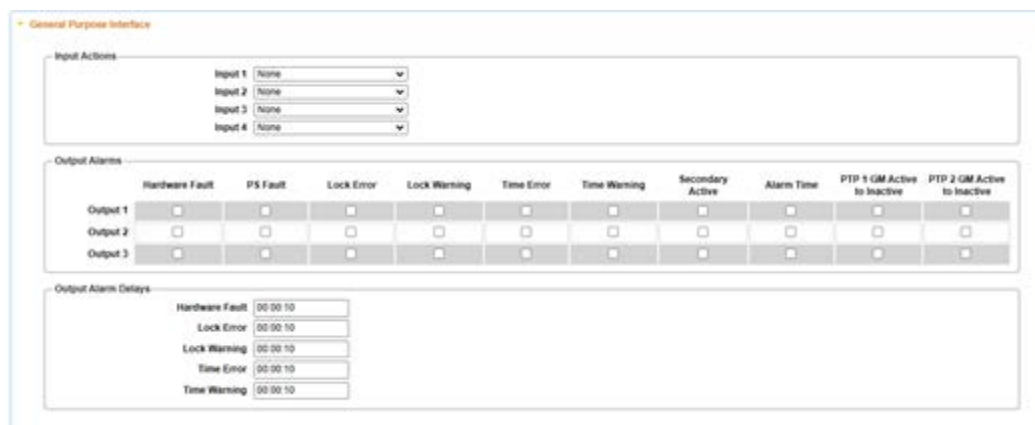

Front-Panel Menu for General Purpose Interface

To use the front-panel menu of the SPG9000 for this process, press **SYSTEM** and then select the **GENERAL PURPOSE INTERFACE** option. See [Menu Operations](#) for details of using the front-panel menus.

The table shows the submenus for the GENERAL PURPOSE INTERFACE menu.

SYSTEM :

PRESET :

INFO :

NETWORK :

FRONT PANEL :

WEB :

GENERAL PURPOSE INTERFACE :

INPUT 1 :

ACTION

PRESET

Only available if Action is Recall Preset

INPUT 2 :

Same menu and submenu as INPUT 1

INPUT 3 :

Same menu and submenu as INPUT 1

INPUT 4 :

Same menu and submenu as INPUT 1

OUTPUT 1 :

Hardware Fault

Power Supply Fault

Lock Error

Lock Warning

Time Error

Time Warning

Secondary Active

Alarm Time

PTP 1 GM Active to Inactive

PTP 2 GM Active to Inactive

OUTPUT 2 :

Same menu and submenu as OUTPUT 1

OUTPUT 3 :

Same menu and submenu as OUTPUT 1

OUTPUT ALARM DELAY :

Hardware Fault

Lock Error

Lock Warning

Time Error

Time Warning

POWER SUPPLY :

FIRMWARE UPGRADE

CALIBRATE OVEN
DIAGNOSTICS

Configuration Settings for General Purpose Interface

Each of the four GPI inputs can be configured to perform independent actions, and the three GPI outputs can be configured to assert for a set of selected events.

Input Actions

Each of the four inputs can cause an action when the input pin is asserted.

None: the GPI input is not in use.

Reset Program Time: the program time counter is reset to its initial value. See [Program Time Counter](#).

Reacquire Position (GNSS): the GNSS receiver is reset to reacquire its position. This is useful if the SPG9000 has just moved to a new location, such as on a mobile broadcast or production vehicle. See [Position](#).

Jam Sync: a jam sync is immediately performed for drop-frame time code outputs. See [Daily Jam Sync](#).

Update Internal Time from NTP: the internal time is updated from a remote NTP server. The time of day source must be set to Internal for NTP client operation. See [Network Time Protocol](#).

Recall Preset: the selected preset is recalled. Either of the built-in presets (power-on default or factory default) or any user-defined preset file can be recalled. See [Presets](#).

Output Alarms

Each of the three outputs can be asserted when any combination of events occur. If multiple events are selected for one output, they are logically ordered together. See [Indicators](#) for the conditions for which event types are reported.

Most alarms cause the GPI output to be asserted (active low) for the entire duration that the alarm condition persists. The Alarm Time event causes the GPI output to be asserted for exactly one second. The PTP 1 and PTP 2 GM Active to Inactive events cause the GPI output to be asserted for a 20 ms pulse.

Hardware Fault: any condition that causes the FAULT indicator to be lit

PS Fault: any condition that causes the PWR 1 or PWR 2 indicators to be red

Lock Error: any condition that causes the REF indicator to be red

Lock Warning: any condition that causes the REF indicator to be yellow

Time Error: any condition that causes the TIME (INPUT) indicator to be red

Time Warning: any condition that causes the TIME (INPUT) indicator to be yellow

Secondary Active: Asserted when the secondary reference is active. See [Secondary Reference](#).

Alarm Time: the program time counter matches the HH:MM:SS digits of the selected alarm time. See [Program Time Counter](#).

PTP 1 GM Active to Inactive and PTP 2 GM Active to Inactive: the PTP instance for the PTP 1 or PTP 2 port has changed state from active leader to passive. This event can be used to signal the changeover unit that the SPG9000 is no longer the grandmaster, so the backup SPG9000 is the source for both the synchronization outputs and PTP. See [PTP Operation](#).

Note: The PTP 1 and PTP 2 GM Active to Inactive events are only asserted for 20 ms instead of asserted persistently. This triggers the changeover unit to change from the primary inputs to the backup inputs when the PTP instance is no longer the grandmaster, but it allows the changeover unit to override this input if one of the monitored signals generates a fault.

Output Alarm Delays

To delay temporary alarm conditions from asserting a GPI output, a delay time can be specified. If the alarm conditions persist after the set delay duration, the output is asserted. Several of the alarms can be set with delays:

- Hardware Fault
- Lock Error
- Lock Warning
- Time Error
- Time Warning

Presets

A preset is a set of configuration parameters for the instrument. Save and recall presets to quickly change configuration settings, instead of changing each parameter individually. The system maintains two special presets (power-on default and factory default) and any number of user-defined presets: [Presets](#)

Web Interface for Presets

In the SPG9000 web interface, select the **System** tab and then select **Preset**.

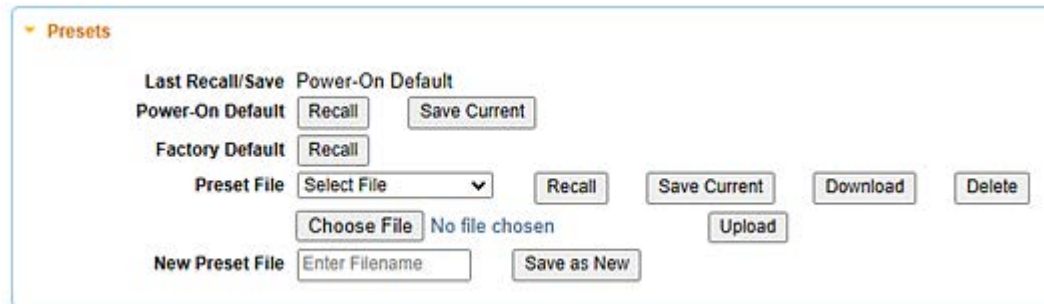

Front-Panel Menu for PRESET

To use the front panel of the SPG9000 for this process, press **SYSTEM** and then select the **PRESET** option. See [Menu Operations](#) for details of using the front-panel menus.

The table shows the submenus for the PRESET menu.

SYSTEM :

PRESET :

POWER-ON DEFAULT (to Save)

POWER-ON DEFAULT (to Recall)

FACTORY DEFAULT

FILE :

RECALL

SAVE

SAVE AS

DELETE

INFO :

NETWORK :

FRONT PANEL :

WEB :

GENERAL PURPOSE INTERFACE :

POWER SUPPLY :

FIRMWARE UPGRADE

CALIBRATE OVEN

DIAGNOSTICS

Configuration Settings for Presets

This section explains the presets, from the preset applied when the instrument turns on to creating new presets. It also explains changes that can be made to presets such as recalling, downloading, and deleting them.

Last Recall/Save

The most recent preset that was recalled or saved is displayed on the web interface to help identify the current state of the system.

Note: If you make additional configuration changes and do not save them to an existing or new preset, the Last Recall/Save preset will no longer reflect the current configuration.

Power On Default

This preset is applied whenever the instrument is powered on. Save the current settings to the Power-On Default preset so they are automatically restored when the instrument is restarted. Recall this preset to reset the configuration since the last time the system was restarted or since this preset was updated. This is useful for applications when the SPG9000 is frequently powered off and on again, such as between different locations for a mobile broadcast truck.

Factory Default

This preset includes the fixed factory default values for most configurable settings in the instrument. Recall this preset to restore the instrument to a known state. The Factory Default preset cannot be updated.

Preset File

There are several options for existing preset files:

Recall User-defined Preset

A saved JSON file can be recalled at any time and the configuration parameters from the preset file restored to the instrument:

1. In the Preset File menu, select the preset file with the needed parameters.
2. Select **Recall**.

Update User-defined Preset

You can update an existing user-defined preset file and overwrite the preset file with the current configuration parameters for the instrument:

1. In the Preset File menu, select the preset file to update.
2. Select **Save Current**.

Download User-defined Preset

You can download a user-defined preset file from the instrument to your computer:

Note: This function is available only on the web interface.

1. In the Preset File menu, select the preset file to download.
2. Select **Download** to open a dialog box from the browser window.
3. In the dialog box, select the folder on your computer to save the preset file to and select **Save**.

Delete User-defined Preset

You can delete a user-defined preset file from the instrument. This removes the file from the list of files in the Preset File menu:

1. In the Preset File menu, select the preset file to delete.
2. Select **Delete**.

Upload User-defined Preset

You can upload a user-defined preset file from your computer and save it on the instrument. It will be added to the list of files in the Preset File menu:

Note: This function is only available on the web interface.

1. Create a preset file on your computer.
There are several ways to create a JSON text file with the correct preset parameters. This is the easiest way:
 - A. Save the current instrument settings to a new file on the instrument.
 - B. Download the file to your computer.
 - C. Edit the file with a text editor.
 - D. Save the edited file.
2. Select **Choose File** and locate the file on your computer.
3. Select **Upload**.

New Preset File

User-defined presets are saved as JSON text files in non-volatile memory on the instrument. To create a new user defined preset:

1. In the New Preset File field, enter the preset name.
2. Select **Save as New**.

The .json filename suffix is added automatically. The new file is added to the menu for the Preset File actions.

Configuration Settings Not Saved in Presets

Several parameters are saved in non-volatile memory of the SPG9000 so they are restored when the instrument is powered off and on again, but they are not saved in

preset files. These are parameters that typically would not change in different operational environments, such as between different mobile production locations:

- Enabled software licenses
- Network parameters:
 - Hostname and domain name
 - Management port IP address, subnet mask, gateway address, DNS server address, system name, and location
 - PTP and IP port addresses, subnet masks, and gateway addresses
- Web server configuration:
 - Web interface passwords
 - API key
 - SSL certificates
- Syslog configuration:
 - Server address
 - Transport protocol
 - Severity level
- SNMP configuration:
 - SNMP and trap enable
 - Trap destination addresses
 - Username and password keys
- NMOS configuration
 - NMOS enable
 - Registry server address
- Front-panel interface settings:
 - Timeout duration
 - Display backlight brightness
 - Beeper enable
- System font selection for text video overlays

File Management

The SPG9000 has non-volatile internal storage for several types of user-created and system-created files:

Presets: Text files (JSON format) that include complete configuration settings for the instrument, or a subset of configuration settings for selected parameters. See [Presets](#).

Images: Full-frame picture files (TIFF format) that can be used for video test signal outputs. See [Test Signal](#).

Logos: Picture files (PNG format) that can be used as an overlay on top of the current background test signal image. See [Overlay](#).

Firmware: System firmware packages that can be used to upgrade the system firmware. See [Upgrade Instrument Firmware](#).

Logs: Syslog files that are saved in volatile memory but can be downloaded to your computer. See [Syslog](#).

Captures: Network packet capture files (pcap format) that can be created from network traffic that is sent and received from the PTP and IP ports. See [Network Packet Capture](#).

You can upload to the instrument, download from the instrument, rename, or delete these files using the File Manager.

On the SPG9000 web interface, select the **System** tab and then select the **File Manager** section.

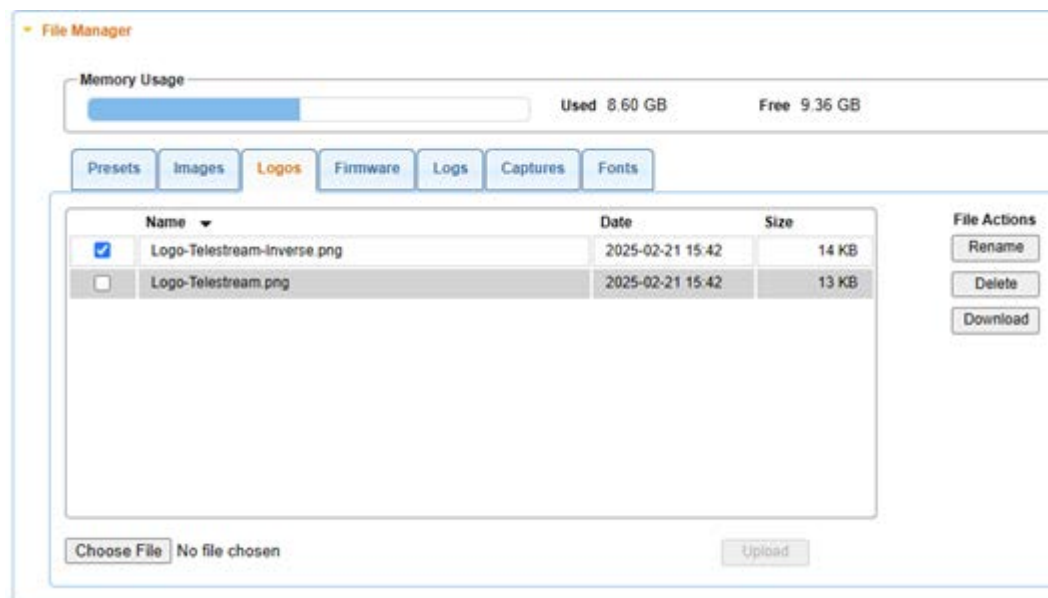

The gauge at the top of the section indicates the current storage memory usage, with the approximate used space and free space displayed.

Note: The memory usage also includes the space used by the operating system and SPG9000 software, not just the space for user files. Therefore, approximately 6-7 GB of space will be shown as “Used” for a SPG9000 system that has no saved user files.

Below the memory usage gauge are a set of tabs that correspond to each type of file. Select the tab to view the files of that type.

Within the tab you will see a table of files, including the filename, date that the file was created, and approximate file size. The checkbox in the leftmost column of each row is used to select one or more files upon which an action can be performed. Select a file and buttons will be enabled on the right side of the table:

Rename: Select to rename the checked file. You can only rename one file at a time, so if two or more files have their checkboxes selected, this button will be unavailable.

Delete: Select to remove the checked file(s) from SPG9000 storage.

Download: Select to download the checked file(s) to your local computer. Your web browser might open a Save As dialog box where you can complete the process, or the file will be automatically saved to the folder configured in your browser settings.

Below the table of files are controls to upload new files from your local computer to the SPG9000.

1. Select **Choose File** to open a file selection dialog box from your web browser. Select a file from your local computer and select **Open**.
2. On the SPG9000 web interface, the selected filename will be displayed to the right of the button. Select **Upload** to complete the process.

Network Packet Capture

For troubleshooting issues with the media ports (PTP 1 & 2 and IP 1 & 2), you can capture network packets on any of these interfaces for offline analysis using programs such as [Wireshark](#). The "pcap" file format is used for packet capture files.

Select the **System** tab and then select the **File Manager** section. Select the **Captures** tab within that section.

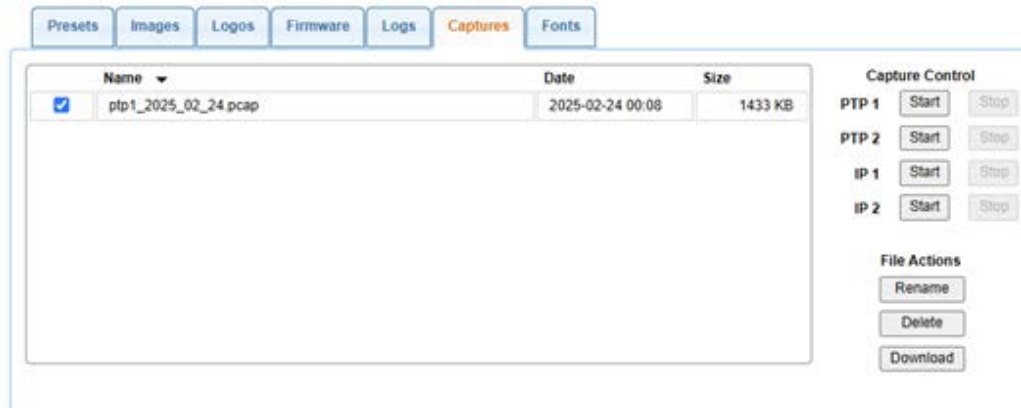

Packet capture is manually controlled from the Start and Stop buttons. These buttons will be disabled if there is no SFP module installed for the corresponding port, or if the port is currently disabled. See [Configuration Settings for PTP Network Interfaces](#) and [Configuration Settings for IP Network Interfaces](#). The capture control buttons are independent for each of the four media ports. Both received and transmitted packets are captured for each port.

Note: The SPG9000-PTP license must be enabled to capture packets for the PTP 1 and PTP 2 interfaces, and the SPG9000-IP license must be enabled to capture packets for the IP 1 and IP 2 interfaces.

The SPG9000 does not forward all Ethernet packets to the internal CPU. Notably, high-bandwidth ST 2110 traffic is filtered by hardware because these packets do not need to be processed by the system. Therefore, the SPG9000 will only capture management plane and control plane protocols such as:

- PTP (Precision Time Protocol)
- ARP (Address Resolution Protocol)
- DHCP (Dynamic Host Configuration Protocol)
- IGMP (Internet Group Management Protocol)
- LLDP (Link Layer Discovery Protocol)
- mDNS (multicast DNS)

When capture is stopped, a new pcap file will be created with a filename that includes the interface name, date, and sequence number. You can rename the file in the SPG9000's storage location or download it to your computer. Deleting the file on the SPG9000 will free its storage space.

Note: Some browsers may consider .pcap files as insecure and block the file download. It is safe to keep these files.

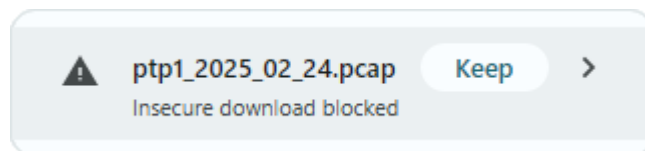

Fonts

The ID text overlay feature uses a system font for character rendering. You can choose the most appropriate font file for the language(s) you will use for ID text. See [ID Text](#) for additional configuration options.

Select the **System** tab and then select the **File Manager** section. Select the **Fonts** tab within that section.

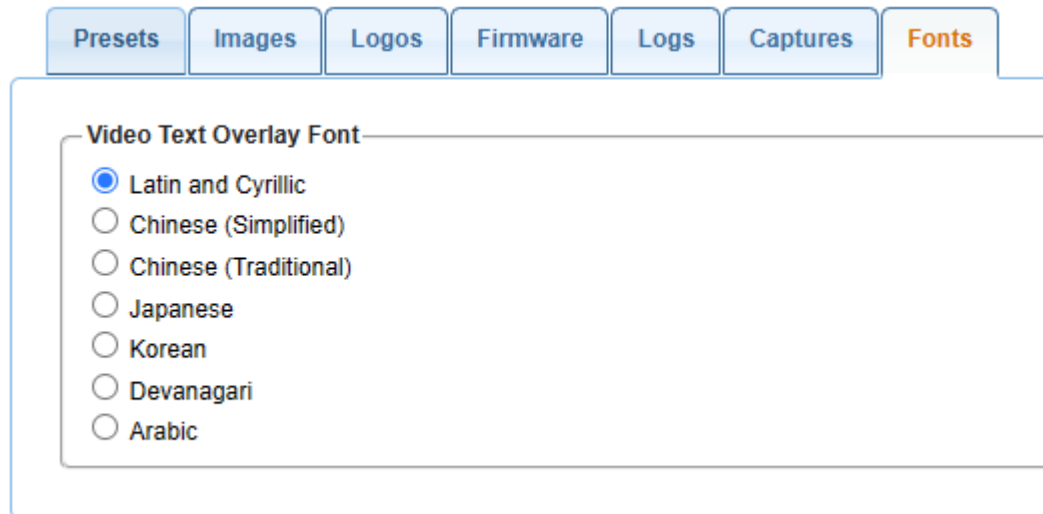

Note: The Action buttons available for other file types are not used for font files. You cannot upload, download, rename or delete the system font files.

Widely used characters, such as uppercase and lowercase Latin letters (with or without accent marks), Arabic numerals, punctuation marks and other symbols are available in every font.

System Status and Monitoring

The SPG9000 has multiple features for monitoring the status of the instrument and its reference signals. The front panel has colored LED indicators for quickly checking several status items, and a set of menus accessed from the STATUS button for more detailed information. The web interface also shows the same indicators on the banner at the top of the page and has a Status tab with detailed information. The web services API has several messages for getting the status of the reference, GNSS, and PTP functions.

Indicators

There are nine colored LED indicators on the front panel of the instrument:



These indicators are mirrored on the web interface, on the right side of the banner at the top of the page. When a physical front-panel indicator changes state, the web page indicator also changes.

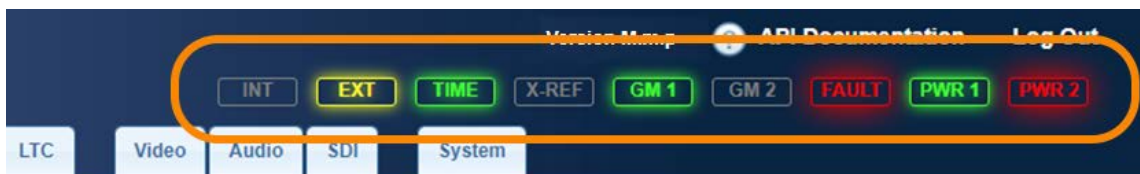

The front-panel indicators are grouped according to function:

Reference

The INT and EXT indicators (located under the REF button) show the status of the reference source. See [Reference Sources](#).

Reference Source	EXT LED State	INT LED State	Operational Status
Internal	Off	Solid green	Good
	Off	Blinking green	Warming up
Genlock Input	Solid green	Off	Locked
	Solid yellow	Off	Near Loss of Lock
	Solid red	Solid green	Unlocked
GNSS Signal ¹	Solid green	Off	Locked
	Blinking green	Off	Secondary reference is active and locked. See Secondary Reference .
	Solid yellow	Off	FOM is less than the GNSS signal warning threshold. See Signal Warning Threshold .
	Blinking yellow	Off	Secondary reference is active but has a lock warning
	Solid red	Solid green	Unlocked or Holdover
PTP Follower ²	Solid green	Off	Locked
	Solid yellow	Off	The reference is locked to the PTP time, but the time from the grandmaster is near the lock range limit of the system.
	Solid red	Solid green	Unlocked or Holdover

1. Option SPG9000-GNSS must be licensed to select GNSS Signal as the reference source.
2. Option SPG9000-PTP must be licensed to select PTP Follower as the reference source.

Time

The INPUT indicator (located under the TIME button) shows the status of the main time-of-day (MTOD) source. On the web interface, the INPUT indicator is labeled TIME. See [Time-of-Day Sources](#) for information on the MTOD source.

Time of Day Source	(TIME) INPUT LED State	Operational Status
Internal	Off	Time is based on the internal main time-of-day register. This might have been previously set by an external source or by manual input.

Time of Day Source	(TIME) INPUT LED State	Operational Status
VITC Input	Solid green	VITC data is present in the genlock input signal and is being used for the MTOD source.
	Solid red	There is no genlock input signal, or the signal is present and there is no VITC data detected, or the VITC data is discontinuous.
LTC Input	Solid green	The LTC input signal is present and is being used for the MTOD source.
	Solid yellow	The timing of the LTC input signal and the genlock input signal are the same frame rate, but the relative timing is outside the SMPTE ST 12 specification.
	Solid red	The LTC input signal is missing, the LTC data is discontinuous, or the LTC frame rate is badly timed relative to the genlock input signal.
GNSS Signal ¹	Solid green	The system is using the time from the GNSS receiver as the MTOD source.
	Solid red	The system is not locked to the GNSS signal.
PTP Follower ²	Solid green	The system is using PTP time as the MTOD source.
	Solid red	The system is not locked to a PTP leader.

1. Option SPG9000-GNSS must be licensed to select GNSS Signal as the time and reference source
2. Option SPG9000-PTP must be licensed to select PTP Follower as the time and reference source

The X-REF indicator (also located under the TIME button) is for future use.

PTP

The GM 1 and GM 2 indicators (located under the PTP button) show the grandmaster status of the PTP 1 and PTP 2 instances respectively. See [PTP Configuration](#). Option SPG9000-PTP must be licensed to enable PTP operation.

GM LED State	PTP Status
Bright green	Active Leader
Dim green	Passive Leader
Red	Faulty
Off	Listening, Disabled, or Follower

FAULT

The FAULT indicator is illuminated when there is a problem with the instrument hardware.

FAULT LED State	Instrument Condition	Examples
Off	The instrument is operating properly.	
Solid yellow	A fault condition exists, but the instrument is still usable.	<ul style="list-style-type: none"> The phase-locked loops (PLLs) are unlocked. A power supply module has reached the TWH limit. See Temperature-Weighted Hours.
Blinking red	A fault condition exists that has the potential to damage the instrument hardware.	<ul style="list-style-type: none"> The main fans have stopped. The internal temperature is too high.
Solid red	A fault condition exists that renders the instrument unusable.	<ul style="list-style-type: none"> A fan speed is out of range. An internal voltage is out of range.

See [System Status](#) to view the detailed diagnostic data. If the FAULT indicator is blinking red or solid red, record the fault details, unplug the instrument from the power source, and contact Telestream customer support.

PWR 1 and PWR 2

These two indicators show the status of the two power supply modules.

Note: If the SPG9000 was purchased with option SPG9000-SPW, only one power supply module is installed in the instrument. If it was purchased with option SPG9000-DPW, two power supply modules are installed in the instrument. A second or replacement power supply can be added at any time by purchasing option SPG9000-ACC-DPW.

When one power supply module is installed, the corresponding PWR 1 or PWR 2 indicator is on and the other indicator is off.

PWR1 / PWR2 Indicator State	Power Supply Module Condition	Description	User Actions
Green	No faults	Normal operation	None

PWR1 / PWR2 Indicator State	Power Supply Module Condition	Description	User Actions
Yellow	Warning	<ul style="list-style-type: none"> • A marginally out-of-range power supply voltage is detected. • The supply has exceeded the specified TWH. See Temperature-Weighted Hours. • The power supply fan has stopped. 	<ol style="list-style-type: none"> 1. Install a second power supply module. 2. Remove the faulted power supply module for repair.
Red	Fault	The power supply voltage is out of range.	<ol style="list-style-type: none"> 1. Install a second power supply module. 2. Remove the faulted power supply module for repair.

When two power supplies are installed, both PWR 1 and PWR 2 indicators are on.

PWR1 / PWR2 Indicator State	Power Supply Module Condition	Description	User Actions
Off	Not installed	The power supply is not properly installed; the system is only detecting one power supply.	Check that the module is fully inserted into its rear panel slot.
Bright green	No faults	This is normal operation for the active power supply.	None
Dim green	No faults	This is normal operation for the inactive (backup) power supply.	None
Yellow	Warning or fault in the active supply	<ul style="list-style-type: none"> • A marginally out-of-range power supply voltage for the active supply is detected. • The supply has exceeded the specified TWH. See Temperature-Weighted Hours. • The active supply fan has stopped. 	<p>If the status of the inactive supply is not faulted (dim green), remove the faulted power supply module for repair. The other supply becomes active.</p> <p>If the status of the inactive supply is also faulted (red), remove that power supply module for repair first.</p>

PWR1 / PWR2 Indicator State	Power Supply Module Condition	Description	User Actions
Red	Fault or no power	<ul style="list-style-type: none"> The power cable for the supply is unplugged, or there is no power from the source. The power supply voltage of the active supply is out of range. The fan of the backup supply has stopped. <hr/> <p>Note: In the case of a failed fan on both supplies, the instrument operates as long as the voltage is adequate.</p>	<ul style="list-style-type: none"> Verify the power cable is connected to the power supply module and the power cable is connected to the power source. Remove the associated power supply module for repair.

Status Information

Detailed status information can be viewed on the Status tab of the web interface. The displays are updated in real-time, so the user can see changes as they occur. A subset of important status information can also be viewed from the front-panel STATUS menu.

Web Interface for Status

On the SPG9000 web interface, click the **Status** tab.

The web page Status contents are organized into several main sections:

Reference includes information about the status of the primary and secondary reference sources, the genlock input signal, and the GNSS receiver status.

Time includes the current time-of-day from its primary source, any local time offsets, status of any time code input, and the current value of the program time counter.

PTP 1 and **PTP 2** include status for the two PTP instances.

System includes diagnostic information for the system hardware, including the power supply modules.

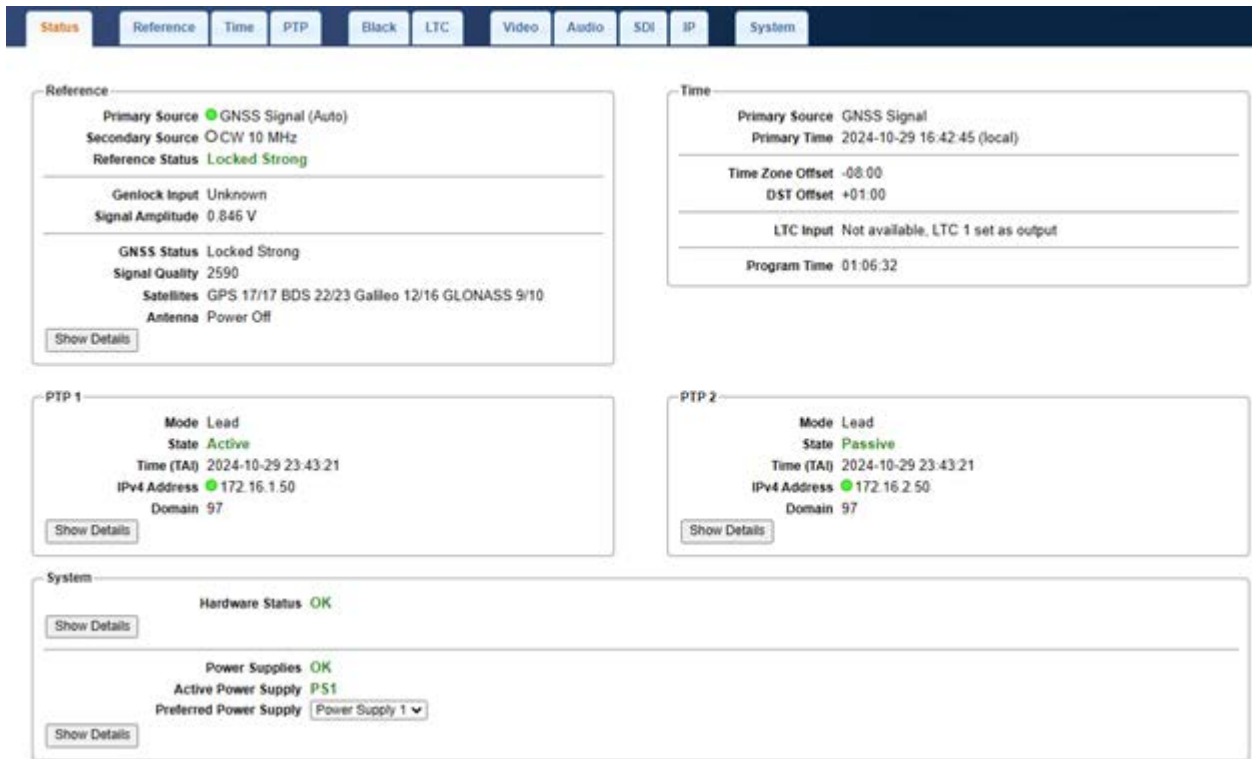

Front-Panel Menu for STATUS

To use the front panel of the SPG9000 for this process, press **STATUS**. See [Menu Operations](#) for details of using the front-panel menus.

The table shows the submenus for the STATUS menu.

STATUS :

FAULT

ALERT

REFERENCE

TIME :

PTP 1 : Only available if the SPG9000-PTP license is enabled

PTP 2 : Only available if the SPG9000-PTP license is enabled

GNSS : Only available if the SPG9000-GNSS license is enabled

The front-panel menus for STATUS are multiple-page menus (see [Multiple-Page Menus](#)), so the user can press the left and right arrow buttons to see all the available information for the current menu.

The FAULT submenu provides additional details if the FAULT indicator is illuminated. See [FAULT](#). If the indicator is not lit, the submenu will display "No faults".

The ALERT submenu provides additional details if there are any signal warnings, such as a loss of lock on the reference source. The menu will update in real-time, so if the condition clears, the menu will change to display "No alerts".

Reference Status

The Reference section on the Status tab contains information about the current reference source, the genlock input signal, and the received GNSS signal.

Note: Option SPG9000-GNSS must be licensed to view GNSS signal status. Without the option, these items are not shown on the web page.

The screenshot shows a web interface titled "Reference" with the following information:

- Primary Source** ● GNSS Signal (Auto)
- Secondary Source** ○ CW 10 MHz
- Reference Status** Locked Strong

- Genlock Input** Signal Present
- Signal Amplitude** 1.358 V

- GNSS Status** Locked Strong
- Signal Quality** 2645
- Satellites** GPS 16/19 BDS 21/21 Galileo 16/17 GLONASS 8/8
- Antenna** Power Off

A "Show Details" button is located at the bottom left of the panel.

Primary Source

Displays the primary reference source, one of:

- Internal
- Genlock Input
- GNSS Signal
- PTP Follower

The colored indicator shows the health of the primary source. Green indicates that the SPG9000 is able to lock to the source, and red indicates that the SPG9000 is not able to lock to the source.

If the primary source is GNSS Signal, a secondary source can be configured. In this mode, if the primary source is active, "(Active)" or "(Auto)" will be displayed after the source type. See [Secondary Reference](#).

Secondary Source

Displays the secondary reference source, if available. If the secondary source is active, "(Active)" or "(Auto)" will be displayed after the source type.

The colored indicator shows the health of the secondary source. Green indicates that the SPG9000 is able to lock to the source, and red indicates that the SPG9000 is not able to lock to the source.

If the secondary source is set to CW 10 MHz and the primary source is active, the SPG9000 can only detect signal presence on the genlock input but not its format. Therefore, the indicator would be blank if the signal is present and red if the signal is missing.

Reference Status

Displays the status of the current reference source. The status text is colored green, yellow, or red indicating good, warning, or error status respectively.

Reference Source	Status Value	Status Color	Description
Internal	Off	Green	The internal oven-controlled MEMS oscillator is used as the frequency reference.
Genlock Input	Locked	Green	Locked to the genlock input signal
	Near Loss of Lock	Yellow	The system is locked but within 1×10^{-6} of the limits of the tune range.
	Unlocked	Red	The system is unable to lock to the genlock input signal.
	Unlocked - Waiting for Manual Lock	Red	The system is waiting for user input to manually relock. This happens when the Lock Action Mode is set to Manual. See Lock Action Mode .
	No Signal	Red	There is no detectable signal at the genlock input.

Reference Source	Status Value	Status Color	Description
GNSS Signal ¹	Locked Strong	Green	Locked to the GNSS signal with 8 or more satellites reporting a carrier-to-noise ratio (C/N) of 40 dB or better
	Locked Nominal	Green	Locked to the GNSS signal with 4 or more satellites reporting C/N of 30 dB or better
	Locked Minimum	Green	Locked to the GNSS signal with 4 or more satellites reporting C/N of 10 dB or better
	Locked (possible jamming or spoofing)	Yellow	Locked to the GNSS signal but the receiver is reporting possible jamming (signal interference from external sources) or spoofing (incorrect signals received from external sources).
	Holdover	Yellow	The system has previously locked to the GNSS signal but is now unlocked. The holdover mode continues until the system relocks.
	Adjusting Phase	Yellow	The system has a good GNSS signal and is now adjusting its time base and frame timing to align with the GNSS signal within 150 ns.
	Acquiring Position	Yellow	The system is acquiring multiple satellite fixes to compute a new position that be stored in non-volatile memory.
	Bad Position	Yellow	The system has detected that the stored position is different from the current position. The position will be reacquired.
	Acquiring Satellites	Yellow	The system is receiving satellite data to determine which signals to use.
Unlocked	Red	The system is unable to lock to the GNSS signal because there is no signal or the signal quality is too low.	

Reference Source	Status Value	Status Color	Description
PTP Follower ²	Locked 50 ns	Green	The system is locked to the PTP leader with an offsetFromMaster value of 50 ns or less, and the system phase is within 50 ns of the PTP-derived timing.
	Locked 100 ns	Green	The system is locked to the PTP leader with an offsetFromMaster value of 100 ns or less, and the system phase is within 100 ns of the PTP-derived timing.
	Locked 250 ns	Green	The system is locked to the PTP leader with an offsetFromMaster value of 250 ns or less, and the system phase is within 250 ns of the PTP-derived timing.
	Locked 1 μ s	Green	The system is locked to the PTP leader with an offsetFromMaster value of 1 μ s or less, and the system phase is within 500 ns of the PTP-derived timing.
	Holdover	Yellow	The system has a valid PTP time from a previous lock, but the PTP instance is no longer tracking the leader.
	Adjusting Phase	Yellow	The PTP instance is tracking within 1 μ s of the PTP leader and the system is now adjusting its time base and frame timing to align with the PTP-derived timing.
	Listening	Yellow	The PTP instance is waiting to receive Announce and Sync messages from a PTP leader in the same domain.
	Unlocked	Red	The PTP instance is disabled, initializing, or faulty (possibly because the link is down).

1. Option SPG9000-GNSS must be licensed to select GNSS Signal as the time and reference source
2. Option SPG9000-PTP must be licensed to select PTP Follower as the time and reference source

Genlock Input

Displays information about the received genlock input signal (from the REF LOOP connectors on the back panel). Detailed information is available when the reference source is Genlock Input. Simple signal detection is the only available status when the reference source is not Genlock Input.

Reference Source	Genlock Input Status	Description
Genlock Input	NTSC Burst	The system is locked to the genlock input signal and the input format is NTSC Burst.
	PAL Burst	The system is locked to the genlock input signal and the input format is PAL Burst.
	Any of the HD tri-level formats, such as 1080 59.94i or 1080 25p	The system is locked to the genlock input signal and the input format is HD Tri-Level. The specific tri-level sync format is displayed. See Web Interface for Genlock Input .
	CW 10 MHz	The system is locked to the genlock input signal and the input format is 10 MHz CW (continuous wave).
	Signal Present	There is a detectable signal on the genlock input, but the system cannot lock to it. This usually indicates a mismatch between the expected genlock input format and the format of the received signal.
	No Signal	There is no detectable signal on the genlock input.
Internal or GNSS Signal or	Signal Present	There is a detectable signal on the genlock input, but the system cannot identify the specific format when the reference source is not Genlock Input.
PTP Follower	No Signal	There is no detectable signal on the genlock input.

Signal Amplitude

Displays the peak-to-peak signal level (in volts) measured at the genlock input. The instrument can lock to signals within -8 to $+6$ dB of the nominal signal level for NTSC, PAL, and HD tri-level formats and 0.5 to 2V for the CW 10 MHz signal.

If the displayed signal amplitude is greater than expected, the loop-through input on the back panel might be unterminated. Connect the second connector to the genlock reference input of another device or add a 75 Ω terminator.

GNSS Status

Displays the status of the received GNSS signal. The possible values and what they mean are listed in the table.

Note: Option SPG9000-GNSS must be licensed for the GNSS status items to appear on the web interface.

GNSS Status Value	Description
Locked Strong	The GNSS signal has data from 8 or more satellites with a carrier-to-noise ratio (C/N) of 40 dB or better.
Locked Nominal	The GNSS signal has data from 4 or more satellites with C/N of 30 dB or better.
Locked Minimum	The GNSS signal has data from 4 or more satellites with C/N of 10 dB or better.
Locked (possible jamming or spoofing)	The GNSS receiver is reporting possible jamming (signal interference from external sources) or spoofing (incorrect signals received from external sources) of the received signal.
Acquiring Position	The system is acquiring multiple satellite fixes to compute a new position that will be stored in non-volatile memory.
Unusable Signal	The pulse-per-second (PPS) signal from the GNSS receiver is questionable.
Acquiring Satellites	The system is receiving satellite data to determine which signals to use.
Low Signal	Some satellites are in view, but none are in fix.
No Signal	No satellites are in view. This is normal for a short time after the signal is applied but if this status persists it usually means one of three problems: there is a problem in the antenna or cable; the antenna is blocked from direct line of sight to the satellites; the power is not getting to the antenna.

Signal Quality

Displays the sum of C/N from all satellites currently in fix. A value of about 200 or higher is usually sufficient for Locked Strong status.

Satellites

Displays the number of satellites in-fix and in-view for each satellite constellation. For example, "GPS 16/17" means 17 GPS satellites are in-view, and 16 of those are in-fix. A satellite whose signal is received by the internal GNSS receiver is counted in-view, but it must be used in the time and position calculation to be counted in-fix. A satellite with a low C/N value or that is low in the sky (close to the horizon) is not used.

Antenna

Displays the status of the external GNSS antenna; the table explains what each value means:

Antenna status value	Description
Normal Operation	The external GNSS antenna is operating normally.
Power Off	The antenna is not powered from the instrument. This is a normal condition if the antenna is powered from an external source. See GNSS Receiver Settings to change the antenna power settings.
Short Circuit	The antenna is shorted. A shorted antenna does not damage the internal GNSS receiver. If a splitter is used on the antenna, it might appear as a short at DC but still pass through the RF signal, which would allow the internal GNSS system to function.
Open Circuit	An open circuit condition occurs if no antenna is connected or if the current load is less than expected because a splitter or DC block is being used.

Show Details

Click to open a panel on the web interface that provides details information about the received GNSS data. The position data of the GNSS antenna is shown along with a table with data of every satellite that is currently in view.

Latitude 45.457788
 Longitude -122.790513 View in Google Maps
 Altitude 45.213

GNSS ID	Satellite	Signal	C/N (dB)	Health	Used
Galileo	7	L1-A	32	ok	no
Galileo	7	E5a	30	ok	no
Galileo	1	L1-A	39	ok	yes
Galileo	1	E5a	40	ok	yes
GPS	14	L1 C/A	46	ok	yes
GPS	14	L5-I	44	ok	yes
GPS	7	L1 C/A	48	ok	yes
Galileo	27	L1-A	48	ok	yes
Galileo	27	E5a	47	ok	yes
GPS	13	L1 C/A	42	ok	no
BDS	45	B1C	45	ok	yes
BDS	45	B2-a	36	ok	yes
Galileo	19	L1-A	41	ok	yes
Galileo	19	E5a	35	ok	yes
GLONASS	12	L1 C/A	43	ok	yes
GLONASS	23	L1 C/A	29	ok	no

Latitude and Longitude

Displays the position in degrees of the GNSS antenna, which might be located at a distance from the GNSS receiver inside the SPG9000. The latitude value is a positive number (0 to 90) for the northern hemisphere and a negative number (–90 to 0) for the southern hemisphere. The longitude value is a positive number (0 to 180) for the eastern hemisphere and a negative value (–180 to 0) for the western hemisphere.

Altitude

Displays the altitude of the GNSS antenna location in meters relative to sea level.

View in Google Maps

Click to open a new browser tab with the location of the GNSS antenna shown at <https://google.com/maps>. This can be used as a diagnostic aid to confirm that the GNSS signal is showing the correction position if there are concerns that the signal is being spoofed.

GNSS ID

Indicates the Global Navigation Satellite System for this satellite.

GNSS ID	System Name	Operator	Coverage
GPS	Global Positioning System	United States	Global
GLONASS	Global Navigation Satellite System	Russia	Global
Galileo	Galileo	European Union	Global
BDS	BeiDou Navigation Satellite System	China	Global
QZSS	Quasi-Zenith Satellite System	Japan	Regional (Asia-Oceania, centered around 135° E longitude)

Satellite

Displays the space vehicle identifier for this satellite. Each GNSS constellation has its own numbering system for its set of satellites.

Signal

Displays the signal identifier. The GNSS receiver of the SPG9000 can receive signals from both the L1 and L5 bands, but this also requires an external antenna that also

supports L1 and L5 frequency bands. If only the L1 signals are visible in this table, it usually means the antenna does not support L5 bands.

Bands	Frequencies	Constellations
L1	1575.42 MHz	GPS, Galileo, QZSS
	1561.098 MHz	BeiDou
	1602 MHz	GLONASS
L5	1176.45 MHz	GPS, Galileo, BeiDou, QZSS

C/N (dB)

Displays the carrier-to-noise ratio in decibels of the satellite signal. Values above 10 are usable for a nominal fix and values above 40 are used for a strong fix.

Health

Reports the satellite's health status. If the status is not OK, the satellite is reporting an issue and the receiver would not use its data for a timing and position solution.

Used

Indicates if this satellite signal is used by the receiver for the timing and position solution. Satellite data is usually used unless the vehicle is low in the sky (close to the horizon) or its C/N value is low.

Time Status

The Time section on the Status tab contains information about the current time-of-day source, local offsets, time code inputs, and the program time counter.

Time	
Primary Source	LTC Input
Primary Time	2023-04-11 08:41:29 (local)
Time Zone Offset	-08:00
DST Offset	+01:00
LTC Input	2023-04-11 08:41:29
LTC Format	30 fps drop-frame
LTC Amplitude	1.87 V
LTC Timing	0.01 ms (ST 12 OK)
Program Time	00:00:22

Primary Source

Displays the current main time-of-day (MTOD) source, one of:

- Internal
- VITC Input
- LTC Input
- GNSS Signal
- PTP Follower

Primary Time

Displays the current main time-of-day value (date and time) including offsets for the local time zone and daylight saving time if applicable.

Time Zone Offset

Displays the current time zone offset relative to UTC. For example, Central European Time (CET) is shown as +01:00 and Pacific Time for North America is shown as -08:00.

DST Offset

Displays the current daylight saving time offset. For standard time, this is 00:00. For daylight saving time (in regions that observe it), the offset is almost always 01:00.

VITC Status

Indicates the presence or absence of the Vertical Interval Time Code (VITC) data on the genlock input signal. When VITC is present, its detected line number in the NTSC or PAL input signal is displayed. The status shows "Discontinuous" for a few seconds if there is an unexpected change in the received time code counter sequence.

VITC Input

Displays the received time code value. If the date and time zone information is encoded (described in SMPTE ST 309), the displayed format is YYYY-MM-DD HH:MM:SS. If the ST 309 data is missing, only the HH:MM:SS digits are displayed.

LTC Input

Displays the received Linear Time Code (LTC) value. LTC 1 must be set to Input mode for the time code to be available. If the date and time zone information is encoded

(described in ST 309), the displayed format is YYYY-MM-DD HH:MM:SS. If the ST 309 data is missing, only the HH:MM:SS digits are displayed.

Note: If the reference source is Genlock Input and the time-of-day source is either VITC Input or Internal, the VITC status is displayed instead of the LTC status.

LTC Format

Displays the detected format of the LTC input signal, such as "30 fps drop-frame".

LTC Amplitude

Displays the detected signal level in volts of the LTC input signal

LTC Timing

Displays the timing offset in milliseconds between the LTC input signal and the genlock input signal. The offset should be within $-32\ \mu\text{s}$ to $+160\ \mu\text{s}$, according to SMPTE ST 12-1. If the measured value is within these limits, a status of ST 12 OK is displayed. If the measured value is outside these limits a status of ST 12 Warning is displayed.

Program Time

Displays the current value of the program time counter. See [Program Time Counter](#).

PTP Status

The PTP 1 and PTP 2 sections on the Status tab contain information about the PTP instances corresponding to the two networks ports labeled PTP 1 and PTP 2 respectively.

Note: Option SPG9000-PTP must be licensed for the PTP status items to appear on the web interface.

Main PTP Status

The PTP status sections include some common items that are always visible as in the example, and a details section that depends on the mode and state of the PTP instance.

PTP 1

Mode Lead
 State Active
 Time (TAI) 2023-08-14 21:53:47
 IPv4 Address ● 192.168.2.198
 Domain 97

[Show Details](#)

Mode

Displays the mode of the PTP instance: Lead, Follow, or Ordinary Clock.

State

Displays the state of the PTP instance according to Table 27 of IEEE 1588-2019.

State Name	IEEE 1588 State	Description
Initializing	INITIALIZING	Temporary state when the PTP instance is re-started after some configuration changes
Faulty	FAULTY	Fault state for the instance, usually because the Ethernet link is down or the IP address is mis-configured. Check the rear panel port indicators (see PTP 1-2 Ports) for link status. See Configuration Settings for PTP Network Interfaces for the IP address settings.
Disabled	DISABLED	PTP instance is currently disabled.
Listening	LISTENING	PTP instance is waiting to receive Announce messages from any PTP leaders on this domain.
Pre-master	PRE_MASTER	Temporary state before the instance becomes a lead clock for the domain
Active or Active Leader	MASTER	Normal state for a leader that is the grandmaster (GM) for the domain. The reference and time-of-day source of this instrument is used for followers in this domain to lock to the GM. If the PTP Mode is set to Ordinary Clock, the state name is shown as Active Leader.
Passive	PASSIVE	Normal state for a leader that is not the GM for the domain. Another PTP leader is functioning as the GM, but this instance can assume the GM role if the Best Master Clock Algorithm (BMCA) decides so. At that point, the instance transitions from Passive to Active.
Uncalibrated	UNCALIBRATED	Temporary state while the PTP instance is making clock adjustments so it can lock to the GM. The instance should transition to the Tracking state when calibration is complete.

State Name	IEEE 1588 State	Description
Adjusting	SLAVE	The follower is locked to the GM for this domain, but the current Offset From Master value is greater than 1 μ s.
Tracking or Follower Tracking	SLAVE	Normal state for a follower that is locked to the GM for this domain and the current Offset From Master value is less than 1 μ s. If the PTP Mode is set to Ordinary Clock, the state name is shown as Follower Tracking.

Time (TAI)

Displays the current time value that is being used by the PTP instance in its messages. PTP uses International Atomic Time (TAI, Temps Atomique International), which is different from Coordinated Universal Time (UTC) by exactly 37 seconds (as of 2025). TAI is continuous and does not use leap seconds. See [Leap Second Management](#).

The Primary Time value displayed at the top right of the Status tab is based on UTC, with adjustments for time zone and DST offsets. Therefore, it differs from PTP TAI time by at least 37 seconds. See [Primary Time](#).

IPv4 Address

Displays the link status and IP address for the PTP 1 or PTP 2 port. See [Configuration Settings for PTP Network Interfaces](#) to configure the IP address parameters.

A colored indicator is used for the link status:

Red: the SFP module is uninstalled, the fiber is not connected, or the link is down for any other reason.

Yellow: the link is active but the interface is waiting for a DHCP server to assign its address.

Green: the link is up. The IPv4 address is displayed next to the indicator.

White: the port is disabled and not in use.

Domain

Displays the domain number for the PTP instance.

Details of Leader PTP Status

The PTP status sections display some information only when the PTP Mode is set to Leader.

Click **Show Details** to see the information. The button changes to Hide Details.

PTP 2

Mode Lead
 State Active
 Time (TAI) 2023-04-19 20:14:01
 IPv4 Address 192.168.2.51
 Domain 120

Hide Details

Profile SMPTE ST 2059-2
 Communication Model Both Multicast and Mixed

Priority 1 128
 Priority 2 128

Clock Identity 00:90:56:FF:FE:01:0F:AB
 Clock Class 6
 Clock Accuracy Within 100 ns (0x21)
 Time Source GNSS

Profile

Displays the PTP profile in use for this instance:

- SMPTE ST 2059-2, typically used for video broadcast applications.

Note: Grandmasters send PTP Management messages once per second with a Synchronization Metadata (SM) TLV. Followers using this profile decode the received SM values.

- AES67, typically used for professional audio applications
- IEEE 1588-2019 Default

Communication Model

Displays the communication model in use by the profile:

- Both Multicast and Mixed: Leader can use either multicast or mixed models, depending on the communication models used by its followers.
- Unicast: All PTP messages are sent to specific IPv4 destination addresses.

Priority 1 and Priority 2

Displays the priority 1 and priority 2 values used by this leader in Best Master Clock Algorithm (BMCA) calculations. A lower number indicates a higher priority.

If the dynamic priority feature is active, the current priority, base priority and offset will be displayed as "98 (100-2)," for example. See [Dynamic Priority](#) for details.

Clock Identity

Displays the clock identity of this leader instance. The clock identity is an 8-byte value that is constructed from the first 3 bytes of the MAC address of the Ethernet port, followed by 0xFF FE, followed by the last 3 bytes of the MAC address. For example, a MAC address of 00-90-56-01-10-01 (as viewed in the Network Settings section of the System tab, see [MAC Address](#)) corresponds to a clock identity of 00:90:56:FF:FE:01:10:01.

Note: The first 3 bytes (00:90:56) of the clock identity values used by the SPG9000 correspond to the Organizationally Unique Identifier (OUI) of Telestream, LLC.

Clock Class

Displays the clock class attribute of this leader instance, according to Table 4 of IEEE 1588-2019. Some common values:

- 6: Instance is directly synchronized to a primary reference time source (such as GNSS).
- 7: Instance was previously using clock class 6 but is now in holdover mode.
- 13: Reference source is Genlock Input and the time-of-day source is a time code input (LTC or VITC) or internal time.
- 14: Instance was previously using clock class 13 but is now in Stay Genlock mode.
- 187: Instance is in Ordinary Clock mode and can be a follower in this domain.
- 248: Default value, used if the instrument is using an internal reference.

Clock Accuracy

Displays the clock accuracy attribute of this leader instance, according to table 5 of IEEE 1588-2019. Both the description and the numeric value (in hexadecimal) of the clock accuracy are displayed.

Time Source

Displays the time source attribute of this leader instance, according to table 6 of IEEE 1588-2019. The SPG9000 can use any of these values:

- GNSS
- PTP
- Hand Set (Internal time-of-day)
- Serial Time Code (LTC or VITC)

Details of Follower PTP Status

The PTP status sections display some information only when the PTP Mode is set to Follower.

Click **Show Details** to see the information. The button changes to Hide Details.

PTP 1

Mode Follow
 State **Tracking**
 Time (TAI) 2023-04-19 20:08:12
 IPv4 Address 192.168.2.50
 Domain 120

Profile SMPTE ST 2059-2
 Communication Model Multicast

GM Clock Identity 00:90:56:FF:FE:01:0F:AB
 GM Clock Class 6
 GM Clock Accuracy Within 100 ns (0x21)
 GM Time Source GNSS

Offset From Master -6 ns
 Path Delay 2.11 μ s
 Leader-Follower Delay 2.12 μ s
 Follower-Leader Delay 2.12 μ s

	Instant.	Average
Announce Rate	1	1
Sync Rate	17	16
Delay_Req Rate	6	7
Delay_Resp Rate	6	7

SMPTe Synchronization Metadata

Frame Rate	60000/1000
Locking Status	Locked
Time Address Flags	Non drop-frame, Color Frame ID not in use
Local Offset	-07:00:37
Next Jump Time	2023-11-05 09:00:37
Jump Seconds	-3600
Next Jam Time	2023-04-20 07:00:37
Previous Jam Time	2023-04-19 07:00:37
Previous Jam Offset	-07:00:37
Daylight Saving	Current DST in effect, Next jump not in effect, Previous jam in effect
Leap Second	Other

Profile

Displays the PTP profile in use for this instance: SMPTE ST 2059-2, AES67, or IEEE 1588-2019 Default

Communication Model

Displays the communication model in use by the profile:

- Multicast: All PTP messages are sent using the assigned multicast IPv4 destination address for PTP (224.0.1.129).
- Unicast: All PTP messages are sent to specific IPv4 destination addresses.
- Mixed Multicast/Unicast: Leaders use multicast for Announce, Sync, Follow_Up, and Management messages. Followers use unicast for Delay_Req messages and the leader also sends the Delay_Resp message as unicast.

GM Clock Identity

Displays the clock identity information that was sent in the Announce message from the leader. See [Clock Identity](#).

GM Clock Class

Displays the clock class information that was sent in the Announce message from the leader. See [Clock Class](#).

GM Clock Accuracy

Displays the clock accuracy information that was sent in the Announce message from the leader. See [Clock Accuracy](#).

GM Time Source

Displays the time source information that was sent in the Announce message from the leader. See [Time Source](#).

Offset From Master

Displays the current Offset From Master measurement, defined as the time error between the lead clock and the follower clock as calculated from the PTP message timestamps. This can be a positive or negative offset, ideally close to zero. A stable PTP lock typically has an Offset From Master value of 100 nanoseconds or less.

Path Delay

Displays the current Path Delay measurement, defined as the mean of the Leader-Follower Delay and Follower-Leader Delay measurements. Typically, these delay values are a few microseconds or less.

Leader-Follower Delay

Displays the current Leader-Follower Delay measurement, computed from the timestamps used with Sync and Follow_Up messages. The leader-follower delay is $t_2 - t_1$. See the messages example illustration.

Follower-Leader Delay

Displays the current Follower-Leader Delay measurement, computed from the timestamps used with Delay_Req and Delay_Resp messages. The follower-leader delay is $t_4 - t_3$. See the messages example illustration.

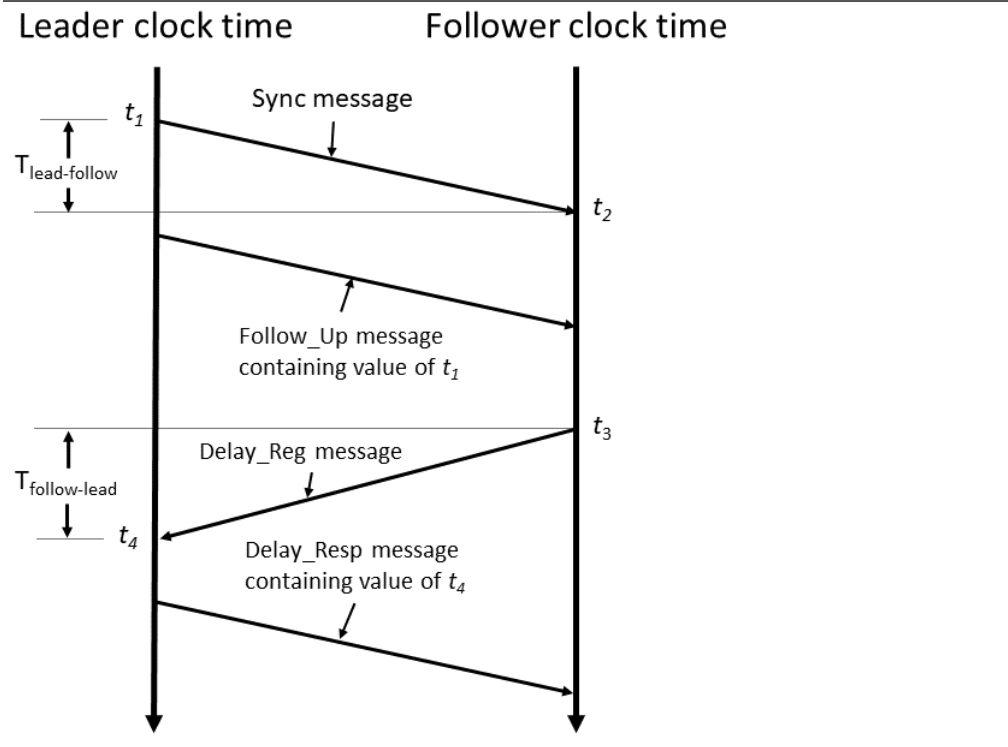

Announce Rate

Displays the instantaneous and average message rates for Announce messages received from all leaders. This rate can be used to verify that messages are being received from at least one leader and at the expected rate.

Sync Rate

Displays the instantaneous and average message rates for Sync messages received from all active leaders.

Delay_Req Rate

Displays the instantaneous and average message rates for Delay_Req messages received from visible followers.

Delay_Resp Rate

Displays the instantaneous and average message rates for Delay_Resp messages received from all leaders.

Note: All messages received on the Ethernet port are counted, including those from other domains.

SMPTE Synchronization Metadata

This table displays the values decoded from the most recent Management message received with the SMPTE ST 2059-2 Synchronization Metadata (SM) TLV. The PTP profile must be set to ST 2059-2 for this data to be sent from the leader and received by the follower.

System Status

The System section at the bottom of the Status tab displays diagnostic information for the instrument hardware.

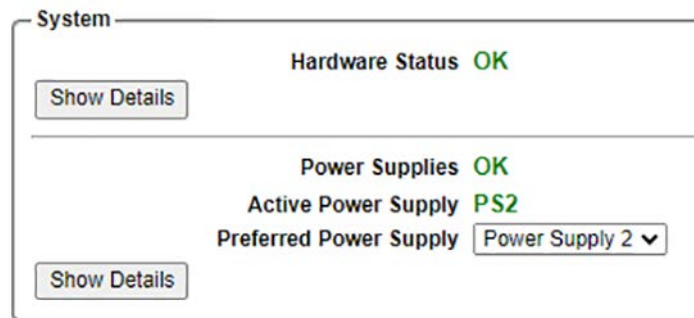

Hardware Status

Indicates if the system is operating normally, or if there are any hardware faults or warnings. Select **Show Details** to open a panel with detailed diagnostic information, including:

- Power-On Self Test (POST) results
- Voltage measurements
- Fan speed measurements
- Temperature sensor measurements
- Oven-controlled MEMS oscillator diagnostic values
- Phase-locked loop (PLL) diagnostic values
- Real-time clock (RTC) battery status
- Other internal diagnostic values

If any values are displayed with a Warning or Error indicator, as in the example, the user might need to contact Telestream Technical Support.



Note: The error indicator is displayed when operating with two power supplies but only one supply is connected to the power source. Connect the second supply to the power source to clear the error condition. If the error indicator is still displayed after the power source is connected to both supplies, replace the faulty supply.

Power Supplies

Shows the state of the power supply modules in the instrument. See [Power Supply Monitoring and Replacement](#) for information on power supply operation.

Select **Show Details** to open a panel with power supply information:

- Measured DC voltage from the power supply
- Number of hours in which the power supply was active or on standby
- Load test history

Reference and Time Sources

This section describes the frequency and time-of-day references for the SPG9000 and how they are used to provide synchronization of its various outputs.

Theory of Operation

The SPG9000 functions by synchronizing its internal clock to a stable frequency source and an accurate time-of-day source. Its outputs are in turn synchronized to that internal clock, ensuring that all devices locked to the SPG9000 are all synchronized with each other.

Epoch-Based Synchronization

The SPG9000 uses epoch-based synchronization. An epoch is a fixed moment in time that is an absolute reference for subsequent events. The SMPTE epoch (defined in ST 2059-1) and the PTP epoch (defined in IEEE 1588-2019) are both 00:00:00 on January 1, 1970 TAI (*Temps Atomique International*). At this time, we can consider video and audio signals of various formats and frame rates to all be aligned with each other.

A video signal with a frame rate of 29.97 (30/1.001) frames per second has a frame duration of about 33.367 ms, but video of 25 fps has a frame duration of 40 ms. At the epoch, and exactly every 1001 seconds afterwards, the two frame sequences are aligned. At any arbitrary time relative to the epoch, we can precisely compute the expected phase of these (or any other) frame rates.

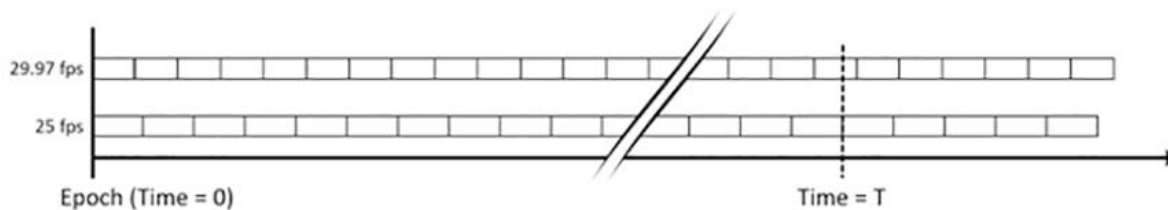

The SPG9000 uses a main time-of-day (MTOD) value that represents the integer and fractional number of seconds since the epoch. For example, a time value of 1677608972.00000000 corresponds to February 28, 2023 at 18:29:32 TAI. TAI time does not include leap seconds, and as of 2025, UTC time is behind TAI by exactly 37 seconds.

When the SPG9000 is synchronized to a GNSS signal it receives a pulse-per-second (1 PPS) signal and a time-of-day value in a data message from its internal GNSS receiver. When synchronized to another PTP grandmaster, it computes the time-of-day value from the exchange of PTP messages. In either case, the SPG9000 adjusts its own MTOD to align with the externally received time so the seconds of the MTOD increment at the same time as the 1 PPS signal.

The SPG9000 also uses three frame-reset signals to synchronize its outputs (Black, LTC, SDI) that can be set to different frame rates:

Frame Reset	Clock Rate	Video Format or Frame Rate (fps)
1	2.997 Hz	NTSC, 29.97, 59.94, 23.98, 47.95
2	6.250 Hz	PAL, 25, 50
3	3.000 Hz	24, 30, 48, 60

When locked to an absolute time source or when in internal mode, the three frames are all aligned as if they started at the epoch. This enables the frames to have predictable and consistent timing relationships and line up every 4004 seconds.

Phase Adjustment

When the SPG9000 is initially powered up and locks to the external reference, there is a phase difference between the external and internal clocks. The SPG9000 forces the internal clock to match the external reference for the initial lock and a quick startup.

When the instrument is locked to an external reference source, its internal clock is continually and slowly adjusted to align with the external reference clock. These adjustments are small so the SPG9000 remains locked without any sudden synchronization or abrupt phase changes.

Afterward, in normal operation, there could be a disruption to the external reference, such as GNSS signal loss. In this case the SPG9000 goes into holdover mode and uses its internal clock to maintain the timing based on the signal history just before signal loss. If the instrument remains in holdover mode for an extended period, a timing offset from the external reference accumulates.

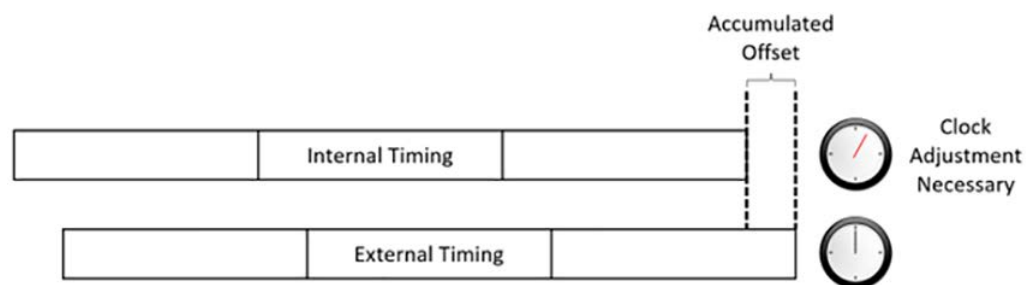

When the external reference is restored, the SPG9000 finds the actual offset between its internal clock to the reference source. The SPG9000 then goes into holdover recovery

mode to re-align the internal clock to the reference clock. The SPG9000 can slowly make this adjustment within clock tolerances that are compliant with SMPTE standards or the SPG9000 can force the adjustment for instant recovery. The stay legal mode (adjustment-within-clock-tolerances method) can take a long time to recover (about 300 seconds for 64 μ s line of timing error) but no synchronization shock occurs.

Reference Sources

There are four choices for the Reference source of the instrument.

Internal

The system uses its internal oven-controlled MEMS oscillator as the timing reference for the instrument. External devices can synchronize to this SPG9000 and synchronize relative to each other, but the SPG9000 itself has independent timing relative to any unconnected devices.

Genlock Input

The system uses the video sync signal received at the loop-through connectors labeled REF LOOP, typically a NTSC or PAL black burst analog video signal, an HD tri-level signal, or a 10 MHz continuous wave (CW) signal. See [Genlock Reference](#).

GNSS Signal

The system uses the PPS output from an integrated GNSS receiver as the timing reference for the instrument. See [GNSS Receiver Settings](#) for configuring the GNSS receiver.

Note: The SPG9000-GNSS option must be licensed for this reference source to be available.

PTP Follower

The system uses an internal PPS signal that is synchronized to an external PTP grandmaster. This source is only available if at least one of the PTP instances is configured as a follower. See [Configuration Settings for PTP Instances](#).

Note: The SPG9000-PTP option must be licensed for this reference source to be available.

Secondary Reference

When the primary reference source of the SPG9000 is configured for the GNSS signal, a secondary reference source may also be configured. This provides additional resiliency

and stability in situations where the GNSS signal may be unreliable. When the system switches from primary (GNSS) to secondary reference, the time-of-day is maintained and the secondary source is used as a frequency reference only.

Two choices are available for the secondary reference source:

- CW 10 MHz signal on the Genlock Input
- PTP Follower

The CW 10 MHz secondary source would typically be used with an external rubidium or cesium atomic clock, to provide a higher-accuracy frequency reference than the SPG9000's internal oscillator that is normally used in holdover mode.

The PTP Follower secondary source is useful as a backup source from a PTP grandmaster from another network, such as an adjacent building or truck.

The reference can be set to automatically switch from the primary source to the secondary source when the GNSS signal is lost, or you can manually switch between sources. For example, the GNSS signal can be used to obtain the accurate time-of-day value, then manually switch to CW 10 MHz for a more stable frequency reference. As required, you could periodically switch back to GNSS to reacquire the time-of-day and then return to the CW signal.

Time-of-Day Sources

The SPG9000 maintains a main time-of-day (MTOD) value that represents the current TAI time. An accurate time-of-day source is necessary for epoch-based synchronization as described above. The MTOD can be modified by various offsets when creating time code outputs. For example, the leap seconds offset is added to TAI time to create UTC time, then a time-zone offset and a daylight-saving-time offset could be applied to the MTOD to create the local time.

There are five options for the MTOD source. The time-of-day source is constrained by the reference source, with seven combinations possible:

Reference	Time-Of-Day Source	Notes
Internal	Internal	
	LTC Input	Only available when LTC 1 is configured as Input. See LTC 1 Mode .
Genlock Input	Internal	
	VITC Input	Only available when Genlock Input format is NTSC or PAL. See Configuration Settings for Genlock Input .
	LTC Input	Only available when LTC 1 is configured as Input. See LTC 1 Mode .

Reference	Time-Of-Day Source	Notes
GNSS Signal	GNSS Signal	
PTP Follower	PTP Follower	

Internal

The system uses a user-supplied date and time value that is entered from the front-panel interface, the web interface, or the application programming interface. The system can also be configured to update the internal time from an external Network Time Protocol (NTP) server using the management network interface. When set, the MTOD accurately tracks real time. The internal time is maintained by a battery-backed, real-time clock (RTC) that preserves the time when the system is powered off. The RTC is automatically updated with the time when the system initially locks to a GNSS signal or PTP leader.

VITC Input

The system reads the date and time from the vertical interval time code (VITC) decoded from the received genlock input signal. The genlock input format must be NTSC Burst or PAL Burst because other genlock input formats (HD tri-level or CW 10 MHz) do not carry VITC data. If the time code only includes time information (hours, minutes, seconds, and frames) but not the date information (year, month, and day), according to SMPTE ST 309, the internal date (from the RTC) is used.

LTC Input

The system reads the date and time from the linear time code (LTC) signal received on the LTC 1 pins of the LTC/GPI connector. See [LTC/GPI Connector](#). LTC 1 can be configured as input or output (see [LTC 1 Mode](#)) and therefore must be set to input for this time source to be available. If the time code only includes time information (hours, minutes, seconds, and frames) but not the date information (year, month, and day), according to ST 309, the internal date (from the RTC) is used.

GNSS Signal

The system uses the date and time information decoded from the received GNSS signal. This time-of-day source is automatically selected and is the only option when the reference source is set to GNSS Signal.

Note: The SPG9000-GNSS option must be licensed for this reference source to be available.

PTP Follower

The system uses the date and time data received from the PTP follower instance. This time-of-day source is automatically selected and is the only option when the reference source is set to PTP Follower.

Note: The SPG9000-PTP option must be licensed for this reference source to be available.

Reference and Time Sources

The reference and time-of-day sources are closely related, and should be configured together.

Web Interface for Reference

On the SPG9000 web interface, click the **Reference** tab.

The screenshot displays the web interface configuration for the Reference and Time Sources. It is organized into three main sections:

- Reference:**
 - Primary Source: Genlock Input (dropdown menu)
 - Loss of Lock Action: Stay at Current Frequency (dropdown menu)
- Genlock Input:**
 - Format: NTSC Burst (dropdown menu)
 - Lock Action Mode: Auto (dropdown menu)
 - Lock Now (button)
- Genlock Timing:**
 - Vertical Delay: 0 lines (input field)
 - Horizontal Delay: 0.00000 μs (input field) and 0.0 ns (input field)
- GNSS Receiver:**
 - GNSS Constellation: GPS + BeiDou + Galileo + GLONASS (dropdown menu)
 - Antenna Power: Off (dropdown menu)
 - Cable Delay: 0.00 μs (input field)
 - Position: Fixed (dropdown menu)
 - Reacquire Fixed Position (button)
 - Signal Warning Threshold: Locked Warning (dropdown menu)

Front-Panel Menu for REFERENCE

To use the front panel of the SPG9000 for this process, press **REF**. See [Menu Operations](#) for details of using the front-panel menus.

The table shows the submenus for the REFERENCE menu.

REFERENCE :	
PRIMARY SOURCE	
SECONDARY SOURCE	Only available if PRIMARY SOURCE is GNSS Signal
ACTIVE SOURCE	Only available if SECONDARY SOURCE is not None
GENLOCK :	Only available if PRIMARY SOURCE is Genlock Input
PTP FOLLOWER	Only available if PRIMARY SOURCE is PTP Follower
LOSS OF LOCK ACTION :	Not available if PRIMARY SOURCE is Internal
HOLDOVER RECOVERY	Only available if PRIMARY SOURCE is GNSS Signal or PTP Follower
GNSS RCVR :	Requires SPG9000-GNSS license to be enabled

Configuration Overview

Setting the reference and time-of-day sources to the configuration is a multistep process for each of the four reference sources:

Set GNSS Signal Source

1. Configure the GNSS receiver. See [GNSS Receiver Settings](#). Wait for a Locked signal. See [GNSS Status Value](#).
2. On the **Reference** tab, in Primary Source, select **GNSS Signal**. The time-of-day source automatically changes to GNSS Signal.
3. Set the [Loss of Lock Action](#) and [Holdover Recovery](#) behavior.
4. Configure the [Secondary Reference](#) if desired.

Set PTP Follower Source

1. Configure one or both of the PTP instances as a follower or Ordinary Clock. See [Configuration Settings for PTP Instances](#). Wait for the PTP instances to reach the Tracking state. See [PTP Status](#).
2. On the **Reference** tab, in Primary Source, select **PTP Follower**. The time-of-day source automatically changes to PTP Follower.
3. If both PTP instances are configured as followers, configure the single or dual follower modes. See [PTP Follower](#).
4. Set the [Loss of Lock Action](#) and [Holdover Recovery](#) behavior.

Set Genlock Input Source

1. On the **Reference** tab, in Primary Source, select **Genlock Input**.
2. Configure the [Configuration Settings for Genlock Input](#) including Genlock Timing.
3. Set the [Loss of Lock Action](#) and [Holdover Recovery](#) behavior.

4. If LTC Input is the required time-of-day source, configure the LTC 1 connector pins to Input mode. See [LTC 1 Mode](#).
5. On the SPG9000 web interface, click the **Time** tab.
6. In Primary Reference, select one of VITC Input, LTC Input, or Internal.
7. Configure the time code input settings if applicable. See [LTC/VITC Mode](#) and [SMPTE 309 Data](#).
8. Set the [Internal Date/Time](#) if applicable.

Set Internal Source

1. On the **Reference** tab, in Primary Source, select **Internal**.
2. If LTC Input is the required time-of-day source, configure the LTC 1 connector pins to Input mode. See [LTC 1 Mode](#).
3. On the SPG9000 web interface, click the **Time** tab.
4. In Primary Reference, select either LTC Input or Internal.
5. Configure the time code input settings if applicable. See [LTC/VITC Mode](#) and [SMPTE 309 Data](#).
6. Set the [Internal Date/Time](#) if applicable or synchronize the internal time from a remote NTP server. See [Network Time Protocol](#).

Configuration Settings for Reference

The reference settings are configured from the Reference tab of the web interface.

Reference

Primary Source PTP Follower ▾

PTP Follower Dual Follower, Port 1 Priority ▾

Loss of Lock Action Stay at Current Frequency ▾

Holdover Recovery Stay Legal ▾

To use the front panel for this process, see [Front-Panel Menu for REFERENCE](#).

Primary Source

Selects the current reference source for the instrument, as described in the [Reference Sources](#).

Reference	Time-Of-Day Source	Notes
Internal	Internal	
	LTC Input	Only available when LTC 1 is configured as Input. See LTC 1 Mode .

Reference	Time-Of-Day Source	Notes
Genlock Input	Internal	
	VITC Input	Only available when Genlock Input format is NTSC or PAL. See Format .
	LTC Input	Only available when LTC 1 is configured as Input. See LTC 1 Mode .
GNSS Signal	GNSS Signal	
PTP Follower	PTP Follower	

The GNSS Signal option is only available if the SPG9000-GNSS license is enabled. The PTP Follower option is only available if the SPG9000-PTP license is enabled, and at least one PTP instance is configured as a follower. See [Configuration Settings for PTP Instances](#).

Secondary Source

Selects the secondary reference source that is used when the primary reference source is unlocked or manually deselected. The secondary source is only available when the primary source is configured to GNSS Signal.

Genlock Input (10 MHz CW): Selects the Genlock Input source for a 10 MHz CW signal. Other genlock formats, such as NTSC Burst, PAL Burst, or HD Tri-Level sync signals are not available for the secondary reference source.

PTP Follower: Selects a PTP Follower. This option is only available if at least one PTP instance is configured as a follower. See [Configuration Settings for PTP Instances](#).

None: Disables the secondary reference source. If the primary source is unlocked, the instrument will directly go to holdover mode.

Active Source

Selects the active source when both primary and secondary reference sources are configured.

Auto: Automatically switches from primary to secondary reference when the primary source is unlocked, and switches back to the primary source when the signal is restored.

Primary: Manually selects the primary reference source, even if the signal is missing or unusable.

Secondary: Manually selects the secondary reference source, even if the signal is missing or unusable.

Note: The reference status on the web interface includes colored indicators for the health of the primary and secondary reference sources, so you can check the signal quality prior to manually switching sources. See [Reference Status](#).

PTP Follower

Selects how PTP instances are used for the reference source. This setting is only applicable when the reference source is set to PTP Follower. If only one PTP instance is set to follower mode, that instance is used. If both PTP instances are available as followers, then this setting determines which instance (or both) is used for the reference source.

PTP 1 Only or **PTP 2 Only**: Uses the specified instance as the reference source. The other PTP instance still operates as a follower and takes performance monitoring measurements if it is tracking its leader. This is useful if the user wants the second PTP instance strictly as a monitoring node on the PTP network.

Dual Follower, Port 1 Priority or **Dual Follower, Port 2 Priority**: Uses either instance as the reference source, with the specified instance as the preferred source. This selection is useful when redundant networks are used, such as with SMPTE ST 2022-7. If the preferred PTP follower loses its lock, the other instance becomes the reference source. The instrument goes into holdover mode briefly during this transition. If both instances lose their PTP lock, the instrument enters holdover mode. If one instance relocks to its PTP grandmaster, it resumes its role as the reference source. If both instances relock, the priority instance is the reference source.

Loss of Lock Action

Selects the instrument's behavior when a loss of lock event occurs. This setting is not applicable when the reference source is set to Internal.

Stay at Current Frequency: Sets the system timing to keep operating at the current frequency from just prior to the loss of lock event. This mode is called Stay Genlock™ when the reference source is Genlock Input, and *holdover* when the reference source is either GNSS Signal or PTP Follower.

Use Internal Frequency: Sets the system timing to use the internal clock at the frequency of the current calibration until the reference source is recovered.

Holdover Recovery

Selects the instrument's behavior when the reference signal is restored after a loss of lock. This setting is only applicable if the reference source is set to GNSS Signal or PTP Follower.

Stay Legal: Adjusts the system clock to match the external reference while staying within the specified frequency offset and frequency rate of change specifications for NTSC and PAL reference signals.

Jam Phase: Adjusts the system clock to match the external reference immediately. This causes a synchronization shock to the system.

Fast Slew: Adjusts the system clock to match the external reference at a rate 25 times faster than the Stay Legal rate, but does not jam and cause synchronization shock.

Web Interface for Time of Day

On the web interface, select the **Time** tab.

The screenshot shows the 'Time of Day' configuration panel. It includes a 'Primary Source' dropdown menu set to 'Internal', an 'Internal Date/Time' field showing '11/28/2023' with a calendar icon, a time field showing '02:07:00 PM' with a clock icon, and a 'Time Zone Offset' field set to '-08:00'. An 'Update Now' button is located on the right side of the panel.

Depending on what Primary Source is selected in the Reference tab (Internal, GNSS Signal, PTP Follower, Genlock Input), the Primary Source in Time of Day will have different options with different options following.

The screenshot shows the 'Time of Day' configuration panel with 'Primary Source' set to 'LTC Input'. It includes an 'LTC/VITC Mode' dropdown menu set to 'Follow', an 'SMPTE 309 Data' dropdown menu set to 'Ignore', and a 'Time Zone Offset' field set to '-08:00'. A 'Synchronize Now' button is located on the right side of the panel.

Front-Panel Menu for TIME OF DAY

To use the front panel of the SPG9000 for this process, press **TIME** and then select the **TIME OF DAY** option. See [Menu Operations](#) for details of using the front-panel menus. The table shows the menus for TIME OF DAY.

TIME :	
TIME OF DAY :	
SOURCE :	
INTERNAL	Only available if SOURCE is Internal
TIME CODE MODE :	Only available if SOURCE is LTC Input or VITC Input
ST 309 DATA :	Only available if SOURCE is LTC Input or VITC Input
TIME ZONE OFFSET :	
NTP CLIENT :	
NTP SERVER :	
DST SCHEDULE :	
PROGRAM TIME :	
JAM SYNC :	
LEAP SECOND :	

Configuration Settings for Time of Day

Configuring the time of day provides a point of reference for the SPG9000. There are several potential sources for this and several aspects of the internal time.

Primary Source

Selects the current time source for the instrument, as described in [Time-of-Day Sources](#). When the reference source is changed, the time-of-day source can be coerced to a valid combination. For example, if the reference source is changed to GNSS Signal, the time source also changes to GNSS Signal. Choose the required reference source before choosing the time-of-day source.

Internal Date/Time

Sets the main time-of-day (MTOD) and the internal real-time clock (RTC) to the specified date and time. These values can only be set manually if the time source is Internal. Click the Update Now button to change both time and date to the new values.

Time Zone Offset

Sets the offset from UTC (in hours and minutes) for the local time zone. A leading plus or minus sign represents time zones west or east of UTC respectively. For example, an offset of +01:00 would be used for Central European Time (CET) and an offset of -05:00 would be used for Eastern Standard Time (EST).

LTC/VITC Mode

Selects the synchronization mode when time code (either LTC or VITC) is used as the time-of-day source. This setting is only available if the time-of-day source is either LTC Input or VITC Input.

Time of Day

Primary Source

LTC/VITC Mode

SMPTE 309 Data

Time Zone Offset

Follow: The time of day follows the time code on the input signal if the signal is stable for at least 100 consecutive frames. If the time code input has any discontinuity, the MTOD also jumps to the new value.

Synchronize Once: The time code on the input signal is continuously monitored until a stable signal is received (at least 100 consecutive frames). At that time, the time of day synchronizes (one time) to this reference. After that, the MTOD counts according to the internal clock.

Synchronize Now: The time of day attempts to synchronize with the time code on the input signal when the user clicks the Synchronize Now button. A total of ten attempts to synchronize are made. After ten attempts, no further attempts are made to synchronize regardless if synchronization occurred or failed. A stable signal of at least 100 consecutive frames is needed.

SMPTE 309 Data

Sets the mode for handling date and time zone information that can be present in the time code data according to the SMPTE ST 309M. This setting is only available if the time-of-day source is either LTC Input or VITC Input.

Ignore: The hours, minutes, seconds, and frames digits of the time code input are used to set the MTOD, but the date and time zone information from the time code input are ignored. The date from the internal real-time clock and the user-specified time zone offset are used instead. This setting is appropriate if the received time code input lacks the date and time zone information, which is possible because ST 309M is not mandatory for ST 12 time code.

Use as Input: The date, time zone, and daylight saving information from the time code input are used to set the MTOD (along with the hours, minutes, seconds and frames digits). For example, if the received time code value is 2023-01-01 20:00:00 with a signaled time zone offset of UTC-08:00, the MTOD is set to 2023-01-02 04:00:37 (TAI). The extra 37 seconds represents the offset from UTC (time code input) and TAI (uses for MTOD). However, in this mode the time code data on LTC and VITC outputs are recalculated using the user-specified time zone offset and any daylight saving time offset. This mode is useful if the incoming time code data is from a different time zone than the outputs the user intends to create.

Use as Output: The date, time zone, and daylight saving information from the time code input are used to set the MTOD. The information is also used for time code outputs. The user-specified time zone offset is ignored. This mode ensures that time code outputs match the time code input.

Network Time Protocol

The SPG9000 can function as a Network Time Protocol (NTP) server, to distribute time to client devices on the same network as the management interface. The SPG9000 can also function as an NTP client to initialize the internal time and date from a remote NTP server.

Web Interface for NTP

On the web interface, click on the **Time** tab.

The screenshot shows two configuration panels. The top panel, titled "NTP Client", contains two input fields for "Remote Servers" with the values "0.pool.ntp.org" and "1.pool.ntp.org". Below these is a "Last Update" field showing "Not Updated" and a button labeled "Update Internal Time Now". At the bottom of this panel is a checkbox for "Update on Restart" which is currently unchecked. The bottom panel, titled "NTP Server", contains a "Service Level" dropdown menu set to "Stratum 1 only" and a "Rate Limiting" checkbox which is checked and labeled "Enable".

Front-Panel Menu for NTP

To use the front panel of the SPG9000 for this process, press TIME and then select the NTP option. See [Menu Operations](#) for details of using the front-panel menus. The table shows the menus for NTP.

TIME :
TIME OF DAY :
NTP CLIENT :
 UPDATE
 REMOTE SERVER 1
 REMOTE SERVER 2
 UPDATE ON RESTART
NTP SERVER :
 SERVICE LEVEL
 RATE LIMITING
DST SCHEDULE :
PROGRAM TIME :
JAM SYNC :
LEAP SECOND :

Configure Settings for NTP Client

The SPG9000 only functions as an NTP client when the reference source is set to either Genlock Input or Internal and the time-of-day source is set to Internal. When the time-of-day source is set to GNSS Signal or PTP Follower, the MTOD continuously follows the accurate time source. When the time-of-day source is Internal, NTP is not used to continuously update the MTOD; instead, NTP updates the current UTC time one time and the internal clock accurately tracks real time from that starting point.

Remote Servers

Specify one or two remote NTP servers; use an IP address or a host name (fully qualified domain name). If the first server does not respond, the second server is used.

Note: If you use host names for the remote NTP server(s), you will need to configure the DNS server to resolve the name. See [Configuration Settings for NETWORK](#).

Update Internal Time Now

Press to manually update the MTOD from the remote NTP server. If the request is successful, the Last Update time is updated with the current local time. This time can be used to determine how long the instrument has been running with the internal clock since it was updated using NTP.

In addition to using the web interface or front-panel interface, the internal time can also be updated from the remote NTP server from a General Purpose Interface input action, or from an API request. See [General Purpose Interface](#) and [HTTP API](#).

Update on Restart

When this option is enabled, the SPG9000 automatically makes a request to the NTP server shortly after the instrument is powered on. This is useful if the power-on default preset includes an Internal time-of-day source and the instrument is frequently powered off and on again, such as in a mobile production truck.

Configure Settings for NTP Server

The SPG9000 can be an NTP server for other clients on the local network. This is useful to distribute accurate time from a GNSS or PTP source to devices that only have a standard network interface.

NTP uses stratum levels to describe the expected accuracy of the system clock. Stratum 0 is defined as the reference clock, such as the internal GNSS receiver or PTP engines within the SPG9000. The stratum level is increased for each “hop” in the network from that reference. Therefore, when the SPG9000 is using the GNSS signal or PTP follower as the time-of-day source, it identifies itself as a stratum 1 server in its NTP messages. A client that receives time from the SPG9000 is a stratum 2 device, and so on.

When the SPG9000 does not have a GNSS or PTP time source, it cannot claim to be a stratum 1 server. When the time-of-day source is Internal, or is a time code input (LTC or VITC), the SPG9000 uses stratum 12 for its NTP messages. This value should be low enough that if a higher stratum server is available, client uses it instead of the SPG9000; but if the SPG9000 is on an isolated network with no other NTP server options, it can still distribute time.

Service Level

Select the operational mode of the NTP server.

Disabled: The SPG9000 does not respond to requests from remote NTP clients.

Stratum 1 only: The NTP server only functions when the time-of-day source is either a GNSS signal or PTP follower.

Stratum 1 or Stratum 12: The NTP server always functions using the stratum level that corresponds to the current time-of-day source.

Note: For a few minutes after the instrument is powered on, responses from the NTP server indicates it is still uninitialized. After the server determines the clock is stable, it responds using stratum 1 or stratum 12, as appropriate.

Rate Limiting

Enable or disable rate limiting for received requests. The NTP server of the SPG9000 has an algorithm to guard against denial-of-service (DoS) attacks. The server will limit the rate at which each individual client may request the time. The long-term average message rate from the client may not exceed one request every 8 seconds. This limit applies to each separate source IP address, so the server can respond to hundreds of messages per second as long as they originate from multiple IP addresses, with each address observing the 1 message per 8 second limit.

Note: It is recommended to only disable the rate limiting function if the SPG9000 is only accessible from a trusted network.

Genlock Reference

When the reference source is set to Genlock Input, additional configuration is necessary. The Genlock Input settings are configured from the Reference tab on the web interface and from the REFERENCE : GENLOCK submenu from the front-panel interface.

Web Interface for Genlock Input

On the web interface, click the **Reference** tab and set the Primary Source to **Genlock Input**. The sample shows a Genlock Input section with additional configuration settings.

Front-Panel Menu for GENLOCK

To use the front panel of the SPG9000 for this process, press **REF** and then select the **GENLOCK** option. See [Menu Operations](#) for details of using the front-panel menus. The table shows the menus for GENLOCK. The GENLOCK submenu is only available when the SOURCE is Genlock Input.

REFERENCE :

SOURCE

GENLOCK :

INPUT FORMAT

TIMING :

Not available if INPUT FORMAT is 1 pps

Vertical

Horizontal Coarse

Horizontal Fine

ACTION MODE

MANUAL LOCK

LOSS OF LOCK ACTION

HOLDOVER RECOVERY

GNSS RCVR :

Requires SPG9000-GNSS license to be enabled

Configuration Settings for Genlock Input

The additional configuration of Genlock Input helps the SPG9000 use the incoming signal.

Format

Selects the expected format for the input signal received at the REF LOOP connector:

NTSC Burst: Sets the expected input format as NTSC black burst (525 lines at 59.94 interlaced fields per second). The signal can have a black level at either 7.5 IRE (NTSC-M) or 0 IRE (NTSC-J, as used in Japan).

PAL Burst: Sets the expected input format as PAL black burst (625 lines at 50 interlaced fields per second).

HD Tri-Level: Sets the expected input format as a tri-level sync signal. The SPG9000 supports genlock using one of several different tri-level formats:

1080 60i	1080 30p	1080 24sF	720 60p
1080 59.94i	1080 29.97p	1080 23.98sF	720 59.94p
1080 50i	1080 25p		720 50p
	1080 24p		
	1080 23.98p		

The instrument automatically detects the specific frame rate, scan type (interlaced, progressive, or segmented frame), and number of lines (1080 or 720) for the input HD tri-level signal.

CW 10 MHz: Sets the expected input format as a continuous wave (CW) signal at 10 MHz frequency.

Lock Action Mode

Selects the behavior after a loss of lock condition and the system is able to relock to the genlock input signal.

Auto: The instrument automatically relocks to the genlock input signal when possible. This could potentially cause a disruption (synchronization shock) to the system timing.

Manual: The instrument waits for the user to manually relock. This mode is useful to avoid synchronization shock at an inconvenient time. While waiting for approval, the EXT indicator (on the front panel and the web interface banner) is red, and the reference status on the web interface shows "Unlocked - Waiting for Manual Lock".

Click **Lock Now** to force the genlock.

Genlock Timing

The Genlock Timing settings adjust the timing offset of the SPG9000 clock relative to the input signal. The selections are only available when the reference source is set to Genlock Input.

The total timing offset is a combination of whole lines (vertical delay) and partial lines (horizontal delay). A negative value means the clock is advanced relative to the genlock input.

Vertical Delay

Enter an integer number of lines in 1-line increments.

Horizontal Delay

The horizontal delay value is the sum of a coarse value (in microseconds) and a fine value (in nanoseconds). Enter the horizontal coarse value in increments of the clock used for the output format. For NTSC and PAL, a 54 MHz clock is used so each coarse step is about 0.0185 μ s. For HD tri-level sync formats, a 74.25 MHz clock (integer frame rates) or a 74.1758 MHz clock (non-integer frame rates) is used so each coarse step is about 0.0135 μ s. Enter the horizontal fine value in increments of 0.1 ns.

The range of the timing adjustment depends on the selected signal format:

Format	Vertical (lines)	Horizontal Coarse (μ s)	Horizontal Fine (ns)
NTSC	± 525	± 63.5556	± 10.00
PAL	± 1250	± 64.0000	± 10.00
1080 60i	± 562	± 29.6296	± 7.00
1080 59.94i	± 562	± 29.6593	± 7.00
1080 50i	± 562	± 35.5556	± 7.00

Format	Vertical (lines)	Horizontal Coarse (μ s)	Horizontal Fine (ns)
1080 30p	± 562	± 29.6296	± 7.00
1080 29.97p	± 562	± 29.6593	± 7.00
1080 25p	± 562	± 35.5556	± 7.00
1080 24p	± 562	± 37.0370	± 7.00
1080 23.98p	± 562	± 37.0741	± 7.00
1080 24sF	± 562	± 37.0370	± 7.00
1080 23.98sF	± 562	± 37.0741	± 7.00
720 60p	± 375	± 22.2222	± 7.00
720 59.94p	± 375	± 22.2444	± 7.00
720 50p	± 375	± 26.6667	± 7.00
CW 10 MHz	± 1125	± 64.0000	n/a

GNSS Receiver Settings

If the reference source is set to GNSS Signal, additional configuration of the internal GNSS receiver might be necessary.

Note: The SPG9000-GNSS license must be enabled for these menus to be available.

Web Interface for GNSS Receiver

On the SPG9000 web interface, click the **Reference** tab.

GNSS Receiver

GNSS Constellation

Antenna Power

Cable Delay μ s

Position

Signal Warning Threshold

Front-Panel Menu for GNSS RCVR

To use the front panel of the SPG9000 for this process, press **REFERENCE** and then select the **GNSS RCVR** option. See [Menu Operations](#) for details of using the front-panel menus. The table shows the menus for GNSS RCVR.

REFERENCE :

SOURCE
 GENLOCK:
 LOSS OF LOCK ACTION :
 HOLDOVER RECOVERY
 PTP FOLLOWER

GNSS RCVR : Requires SPG9000-GNSS license to be enabled

CONSTELLATION
ANTENNA POWER
CABLE DELAY
POSITION
ACQUIRE POSN
SIGNAL WARNING

Configuration Settings for GNSS Receiver

The additional configuration of the GNSS receiver helps the SPG9000 find and track the satellite and satellite signal.

GNSS Constellation

Selects the satellite constellation to track. The SPG9000 can receive data from up to four different global navigation satellite systems and one regional system:

GNSS	System Name	Operator	Coverage
GPS	Global Positioning System	United States	Global
GLONASS	Global Navigation Satellite System	Russia	Global
Galileo	Galileo	European Union	Global
BeiDou	BeiDou Navigation Satellite System	China	Global
QZSS	Quasi-Zenith Satellite System	Japan	Regional (Asia-Oceania, centered around 135° E longitude)

Select one of the specific combinations of available systems:

- GPS Only
- BeiDou Only
- Galileo Only
- GPS + GLONASS
- GPS + BeiDou

- GPS + Galileo
- GPS + QZSS
- GPS + BeiDou + Galileo + GLONASS

For most applications, the GPS + BeiDou + Galileo + GLONASS selection is the best choice because more satellites are available to compute the timing solution.

Antenna Power

Selects the power setting for the GNSS Antenna connector on the rear panel:

- Off:** No power is supplied to the GNSS antenna
- 3.3 Volt:** Supplies 3.3 V DC to power the GNSS antenna
- 5 Volt:** Supplies 5 V DC to power the GNSS antenna

CAUTION: To avoid antenna damage, do not turn on the DC antenna power until you know the antenna is designed to handle the specific voltage. Antenna damage can occur if the antenna is not designed to handle the selected voltage.

When the GNSS ANT connector is configured to provide power to the antenna, the rear panel POWER indicator is on:

- Blinking green means an open circuit. This occurs if no antenna is connected or if the current load is less than expected because a splitter or DC block is being used.
- Solid red means the connected antenna is shorted. A shorted antenna does not damage the GNSS receiver. If a splitter is used on the antenna, it might appear as a short at DC but still pass through the RF signal, which would allow the internal GNSS system to function.
- Solid green means the current load of the antenna is within the nominal range.

Cable Delay

Sets a delay value to compensate for the cable length from the antenna to the instrument. The propagation delay depends on the cable type but is typically 5 nanoseconds per meter. The timing delay can be adjusted to a maximum of 99 microseconds. The delay value is negative to compensate for the positive delay from the physical cable.

Position

Selects the mode in which the GNSS receiver calculates time and position information:

- Fixed:** An averaged position is stored in flash memory, and only the time is calculated each second. This provides greater stability of the time information and

allows operation with fewer satellites. This mode is well suited to installations such as a broadcast facility, where the antenna and instrument do not move.

Mobile: Recalculates both the position and time each second. This allows for compensation of velocity and acceleration, so the frequency and timing information stay correct while moving, at the expense of some stability. This mode is required if the antenna and instrument are moving, such as an electronic news gathering vehicle.

For applications where the position changes occasionally, but where the antenna and instrument are not moving, then either mode can be applicable. Mobile mode might start up faster since it does not need to average 60 fixes to establish a fixed location. However, fixed mode can operate with fewer satellites when the position is stored.

Signal Warning Threshold

Selects the GNSS status level below which a warning notification would occur.

There are several possible ways a user can be notified:

- If the reference source is set to GNSS Signal, the EXT indicator on the front panel and the web page is yellow. See [Indicators](#).
- A message at the warning severity level is sent to the system log. A message at the informational severity level that includes GNSS signal information is also sent to the system log every 32 seconds, even if the signal status has not dropped below the warning threshold. See [Syslog](#).
- An SNMP trap message is sent. See [SNMP](#).
- If the reference source is set to GNSS Signal, a Lock Warning alarm can be signaled. See [General Purpose Interface](#).

Select the signal warning threshold level. See [GNSS Status](#) for a complete list of status levels.

Locked Warning: The GNSS receiver is reporting possible jamming (signal interference from external sources) or spoofing (incorrect signals received from external sources) of the received signal.

Locked Minimum: The GNSS signal has data from 4 or more satellites with a carrier-to-noise ratio (C/N) of 10 dB or better.

Locked Nominal: The GNSS signal has data from 4 or more satellites with C/N of 30 dB or better.

Locked Strong: The GNSS signal has data from 8 or more satellites with a carrier-to-noise ratio (C/N) of 40 dB or better.

For example, if the threshold is set to Locked Warning, a notification occurs if the GNSS Status is in any of the unlocked states (from No Signal to Acquiring Position). If the threshold is set to Locked Strong, a notification occurs if the GNSS Status is any other state.

Daily Jam Sync

For installations that use drop-frame time code, such as NTSC black outputs with VITC, a daily jam sync event is required.

Drop-frame time code (defined in ST 12-1) is used for non-integer frame rates, specifically 29.97 (30/1.001) and 59.94 (60/1.001) frames per second. In actuality, video frames aren't dropped; instead, the frame counter skips two counts every minute, except for every 10th minute. For example:

HH:MM:SS;FF	Description
12:06:23;29	30 fps time code normally counts frames from 00 to 29 each second. When the seconds digits change from 23 to 24, the frame counter rolls over from 29 to 00.
12:06:24;00	
...	
12:07:59;29	The 00 and 01 frame counts are skipped when the minutes digits change, in this case from 07 to 08. The frame digits skips from 29 to 02.
12:08:00;02	
...	
12:09:59;29	When the minutes digits change to 00, 10, 20, 30, 40, or 50, the frames digits do not skip 00 and 01, but roll over from 29 to 00.
12:10:00;00	

There are 107,892 frames counted in a time code hour, such as from 00:00:00;00 to 01:00:00;00, but the true frame rate of 30/1.001 results in approximately 107,892.108 frames per hour, that is, with 0.108 more fractional frames every hour. The drop-frame algorithm corrects for most of the difference between 30 fps count and 30/1.001 frame rate, but there is a small difference that accumulates approximately 2.6 frames every 24 hours.

To prevent that offset from diverging indefinitely, the solution is to perform a regular (daily) jam sync. At the scheduled time, 2 or 4 additional frame counts are skipped.

Web Interface for Jam Sync

On the SPG9000 web interface, click the **Reference** tab.

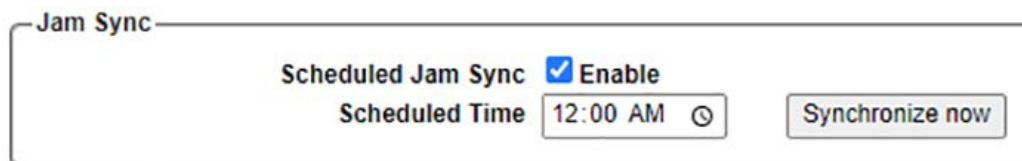

Front-Panel Menu for JAM SYNC

To use the front panel of the SPG9000 for this process, press **TIME** and then select **JAM SYNC**. See [Menu Operations](#) for details of using the front-panel menus. The table shows the menus for JAM SYNC.

TIME :

TIME OF DAY :

NTP CLIENT :

NTP SERVER :

DST SCHEDULE :

PROGRAM TIME :

JAM SYNC :**MANUAL****MODE****SCHEDULED TIME**

LEAP SECOND :

Configuration Settings for Jam Sync

The jam sync configuration enables the jam sync and defines when it happens.

Scheduled Jam Sync

Select to enable a daily jam sync. We recommend this when using 30 fps drop-frame time code on any outputs, but is not needed when working exclusively with integer frame rates such as PAL and 25 fps.

Scheduled Time

Enter the local time of day (hours and minutes) for the daily jam sync. Typically, a time such as 02:00 am is used in broadcast applications, when the viewing audience is small. The selected time must have minutes digits of 00, 10, 20, 30, 40, or 50 past the hour.

Daylight Saving Time Management

In several parts of the world, daylight saving time (summer time) is in effect during warmer months so darkness occurs at a later time in the day. Typically, local clocks are advanced one hour in the spring and return to standard time (winter time) in autumn.

On the SPG9000, a daylight saving time offset is used (along with the time zone offset) to compute the local time that can be used in time code outputs.

Web Interface for Daylight Saving Time

On the SPG9000 web interface, click the **Time** tab.

The screenshot shows the 'Daylight Saving Time' configuration page. It includes the following fields:

- Scheduled Mode:** A dropdown menu set to 'Disable'.
- Offset:** A text input field containing '+01:00'.
- Once Date/Time:** A date picker set to '01/01/2022' and a time picker set to '12:00 AM'.
- Recurring Start:** A dropdown set to 'Second', a day dropdown set to 'Sunday', a month dropdown set to 'March', and a time picker set to '02:00 AM'.
- Recurring End:** A dropdown set to 'First', a day dropdown set to 'Sunday', a month dropdown set to 'November', and a time picker set to '02:00 AM'.

Front-Panel Menu for DST SCHEDULE

To use the front panel of the SPG9000 for this process, press **TIME** and then select the **DST SCHEDULE** option. See [Menu Operations](#) for details of using the front-panel menus. The table shows the menus for DST SCHEDULE.

TIME :

TIME OF DAY :

NTP CLIENT :

NTP SERVER :

DST SCHEDULE :

MODE

OFFSET

ONCE DATE/TIME

RECURRING START

RECURRING END

PROGRAM TIME :

JAM SYNC :

LEAP SECOND :

Configuration Settings for Daylight Saving Time

The daylight saving time configuration allows the SPG9000 to change the internal time as needed when DST starts and ends.

Scheduled Mode

Selects the daylight saving schedule mode used by the instrument:

Disable: No daylight saving time offset is used.

Once: At the specified time, the daylight saving offset is applied and the mode resets to Disable. That is, only a single time change is scheduled until the user sets a new schedule.

Recurring: Use the rules defined by the Recurring Start and Recurring End menus to keep an indefinite schedule of DST changes. We recommend this mode for most applications.

Offset

Enter the time offset (hours and minutes) to apply when the daylight saving event occurs. For the Once mode, the offset is applied a single time. Use a positive offset to advance the local clock to daylight saving time or a negative offset to return the local clock to standard time.

Once Date/Time

Enter the date and local time of day (hours and minutes) for the daylight saving time event to occur for Once mode.

Recurring Start

Enter the relative date and local time of day for daylight saving time to begin. The relative date is described using the day of the week and the ordinal number (for example First, Second, Last) of that day within the month. The rules (as of 2025) for daylight saving time in several parts of the world are listed:

Regions	Start	End
Most of United States and Canada	Second Sunday in March at 02:00	First Sunday in November at 02:00
European Union	Last Sunday in March at 01:00 UTC	Last Sunday in October at 01:00 UTC
Parts of Australia	First Sunday in October at 02:00	First Sunday in April at 03:00

Note: In European countries that observe daylight saving time, the local clocks change simultaneously at 01:00 UTC, which can be 01:00, 02:00, or 03:00 local time. Be sure to use local time when setting the DST start and end times on the SPG9000.

Recurring End

Enter the relative date and local time of day for daylight saving time to end.

Leap Second Management

A leap second is a one second adjustment that can be applied to UTC time to accommodate the difference between TAI time and the observed solar time, which varies due to irregularities in the earth's rotation. A leap second can be added at the discretion of the International Earth Rotation and Reference Systems Service (IERS). As of 2025, the most recent leap second was at the end of 2016.

Leap seconds are typically inserted just before 00:00:00 UTC on July 1 or January 1. For example, the positive leap second inserted at the end of 2016 resulted in a time sequence of:

2016-12-31 23:59:59	
2016-12-31 23:59:60	Normally the seconds digits would roll over from 59 to 00.
2017-12-31 00:00:00	

A hypothetical negative leap second would cause the time sequence to roll over from 23:59:58 to 00:00:00 (skipping the 59th second), but a negative leap second has never happened since the introduction of leap seconds in 1972.

If a leap second is scheduled to occur, it is signaled by GNSS data. GPS, Galileo, and BeiDou satellites send the date and time of the next leap second adjustment and the current number of leap seconds in their respective data messages. A "leap second pending" flag is set in the data message several months before the event. When the actual leap second occurs, the UTC offset is updated and the flag is cleared. A PTP grandmaster that is synchronized to GNSS can also signal this information to its followers using the ST 2059 synchronization metadata.

Because leap second adjustments always happen at 00:00:00 UTC, this could be an inconvenient time for some applications. For example, that time would be 19:00 in the Eastern time zone of the United States and Canada, at the start of prime-time television programming. Therefore, the SPG9000 has the ability to postpone the adjustment by up to 24 hours. The user can choose a time such as 04:00 in the local time zone, when there are few viewers.

In some installations the GNSS signal is not available, such as when the SPG9000 is used in a mobile production truck that does not have clear access to the sky. In these situations, the current leap second offset between UTC and TAI time must be configured differently. You can manually enter the offset or you can query a web service for the offset.

Web Interface for Leap Second

On the SPG9000 web interface, click the **Time** tab. The leap second configuration parameters depend on the time-of-day source. For GNSS Signal and PTP Follower time sources, you can configure the time when leap second adjustments are applied.

The screenshot shows a web interface for Leap Second configuration. It has a title "Leap Second" and two main settings: "Mode" is set to "Use GNSS Time (00:00 UTC)" with a dropdown arrow, and "Scheduled Time" is set to "12:00 AM" with a clock icon.

When the time-of-day source is Internal, LTC Input, or VITC Input, you can configure the offset between UTC and TAI time.

The screenshot shows a web interface for Leap Second configuration. It has a title "Leap Second" and three main settings: "UTC to TAI Offset" is set to "37" with the unit "seconds" and a "Query Web" button; "Update on Restart" is checked; and "Announce as Valid" is checked.

Front-Panel Menu for LEAP SECOND

To use the front panel of the SPG9000 for this process, press **TIME** and then select the **LEAP SECOND** option. See [Menu Operations](#) for details of using the front-panel menus. The table shows the submenus for the LEAP SECOND menu.

TIME :

TIME OF DAY :
NTP CLIENT :
NTP SERVER :
DST SCHEDULE :
PROGRAM TIME :
JAM SYNC :

LEAP SECOND :

MODE :	Only available if primary reference source is GNSS Signal or PTP Follower
OFFSET :	Only available if primary reference source is GNSS Signal or PTP Follower
UTC-TAI OFFSET :	Only available if primary reference source is Internal or Genlock Input
QUERY ON RESTART :	Only available if primary reference source is Internal or Genlock Input
ANNOUNCE VALID :	Only available if primary reference source is Internal or Genlock Input

Configuration Settings for Leap Second

The leap second configuration depends on the time-of-day source.

- For GNSS Signal and PTP Follower time sources, you can configure the time when the leap second adjustments are applied via the following settings:
 - Mode
 - Scheduled Time
- For Internal, LTC Input, and VITC Input time sources, you can configure the offset between UTC and TAI Time via the following settings:
 - UTC to TAI Offset
 - Query Web
 - Update on Restart
 - Announce as Valid

Mode

Select when the leap second adjustment should be made:

Use GNSS Time (00:00 UTC): Use the default behavior of making the adjustment at 00:00 UTC, regardless of the local time zone.

Defer to Schedule Time: Defer the leap second adjustment up to 24 hours, to the specified local time.

Scheduled Time

Enter the local time (hours and minutes) for the leap second adjustment.

UTC to TAI Offset

Enter the integer number of seconds between UTC and TAI. As of 2025, this value is 37 seconds.

Note: The text box on the web interface will be highlighted in red if the offset value is not yet trusted to be correct after the system has powered up. The value is trusted when it is updated or confirmed from this text box, or when the web server is successfully queried for the current value.

Query Web

Press to update the UTC to TAI offset value from a trusted server hosted by the International Earth Rotation and Reference Systems Service (IERS).

Note: You will need to configure the DNS server to resolve the address of the IERS server. See [Configuration Settings for NETWORK](#).

Update on Restart

When this option is enabled, the SPG9000 automatically makes a request to the IERS server shortly after the instrument is powered on. This is useful if the power-on default preset includes an Internal time-of-day source and the instrument is frequently powered off and on again, such as in a mobile production truck.

Announce as Valid

When this option is enabled, the SPG9000 assumes the UTC to TAI offset value is trusted to be correct, and will assert the appropriate flag in PTP Announce messages to indicate the validity.

Program Time Counter

As an alternate to the time-of-day, a program time counter can be used as a time code source for any output. This counter can represent elapsed time, such as the time code associated with program content during the editing process.

The program time counter starts counting from the user-specified initial value. Program time can be reset to this value at any time using the user interface, the web services API, or the general purpose interface.

Web Interface for Program Time

On the SPG9000 web interface, click the **Time** tab.

The screenshot shows a web interface titled "Program Time". It contains the following elements:

- Initial Time:** A text input field containing "01:00:00".
- Apply Initial Time Now:** A button with a green border and text.
- Alarm:** A checkbox labeled "Enable" which is currently unchecked.
- Alarm Time:** A text input field containing "00:00:00".

Front-Panel Menu for PROGRAM TIME

To use the front panel of the SPG9000 for this process, press **TIME** and then select the **PROGRAM TIME** option. See [Menu Operations](#) for details of using the front-panel menus. The table shows the submenus for the PROGRAM TIME menu.

TIME :

TIME OF DAY :

NTP CLIENT :

NTP SERVER :

DST SCHEDULE :

PROGRAM TIME :

RESET

INITIAL TIME

ALARM

ALARM TIME

JAM SYNC :

LEAP SECOND :

Configuration Settings for Program Time

The program time configuration includes a reset of the time counter and alarms to note when the selected value is reached.

Initial Time

Set the initial time for the program time counter, in hours, minutes, and seconds (HH:MM:SS).

Apply Initial Time Now

Click to reset the program time counter to the initial value.

Alarm

Check this box to enable the program time alarm. When the program time counter reaches the alarm time, a notification event is generated in the system log, and an output pin of the general purpose interface can be asserted. See [Syslog](#) and [General Purpose Interface](#).

Alarm Time

Enter the required program time counter value (in the format HH:MM:SS) to trigger the alarm.

PTP Operation

Precision Time Protocol (PTP) is defined by IEEE Std 1588™-2019, *IEEE Standard for a Precision Clock Synchronization Protocol for Networked Measurement and Control Systems*. The protocol is used to synchronize clocks using an IP network.

The SPG9000 has two dedicated network interfaces for PTP. The instrument can operate as a leader or grandmaster (GM), providing accurate time-of-day to a set of followers that are synchronized to it, or it can operate as a follower to another GM. Each PTP instance can also be configured as an Ordinary Clock that adapts between leader and follower in response to other PTP devices on the network. As either a leader or a follower, the SPG9000 outputs (black burst, time code, etc.) are synchronized to PTP time.

Note: The SPG9000-PTP license must be enabled for the PTP ports to be operational.

Theory of Operation

PTP operates by exchanges of IP messages between leaders and followers. Through these messages the time of the grandmaster clock is distributed to all other instances so they are all synchronized and share the same time.

A PTP instance is an implementation of the PTP protocol engine that is associated with one or more physical network interfaces. The SPG9000 has two PTP instances; each uses one network port. The two instances are independent of each other, and can operate in different modes and run at different interface speeds.

Messages Types

There are seven different PTP message types used by the PTP implementation in the SPG9000. Four timing messages (Sync, Follow_Up, Delay_Req, and Delay_Resp) are used to exchange time information between leaders and followers:

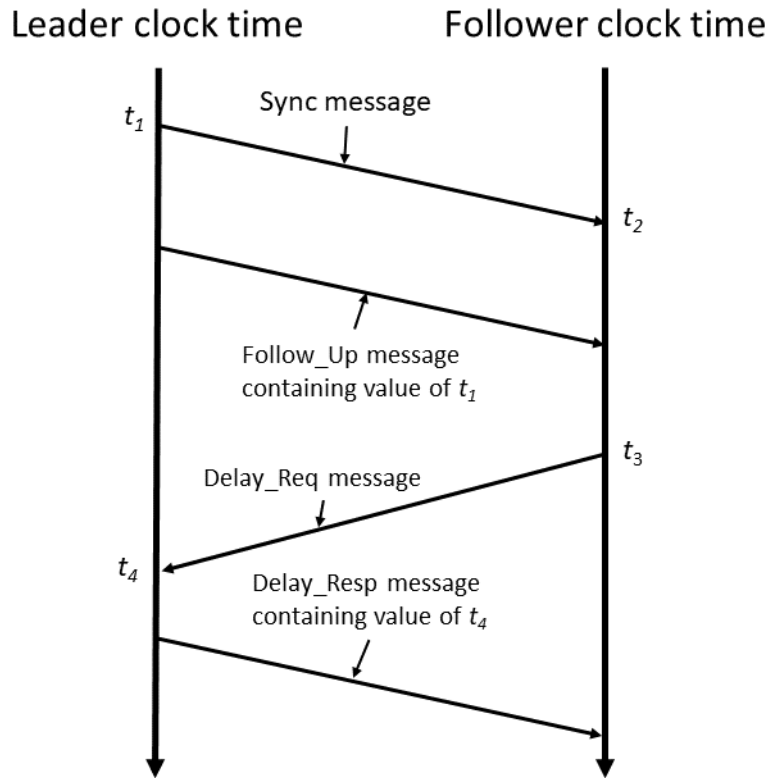

Sync

The Sync message is sent by the leader and is used to measure the propagation delay from the leader to follower. The Sync message might contain the timestamp indicating when it was transmitted, or that timestamp might be in the Follow_Up message. The receiver must timestamp the Sync message upon receipt. These two timestamps are usually called t_1 and t_2 and provide the first delay measurement: leader-to-follower delay or $t_2 - t_1$.

Follow_Up

The Follow_Up message is sent when the PTP network hardware does not insert the t_1 timestamp into the Sync message. Instead, the t_1 timestamp is included in a corresponding Follow_Up message; this is called two-step operation. If the Sync message does include its t_1 timestamp, the Follow_Up message is not required; this is called one-step operation.

A leader instance on the SPG9000 uses two-step operation and sends both Sync and Follow_Up messages. A follower instance on the SPG9000 can operate with either one-step or two-step leaders.

Delay_Req

The Delay_Req message is sent by the follower. The timestamp at which it is transmitted (t_3) is noted by the follower but is not included in the message. When this Delay_Req message is received by the leader, it timestamps the receive time of the message as t_4 .

Delay_Resp

The Delay_Resp message is sent from the leader to the follower in response to the associated Delay_Req message. The response contains the t_4 timestamp from when the leader received the Delay_Req message. When the follower receives the Delay_Resp message, it has the second pair of timestamps needed to calculate the second delay measurement: follower-to-leader delay or $t_4 - t_3$.

Announce

The Announce message is sent by the leader to advertise its capabilities. This message contains the clock quality and priority settings needed for the [Best Master Clock Algorithm](#) to evaluate which instance is the best leader.

Management

Management messages are typically used by external systems to query and update data sets used by the PTP instance through in-band messaging. For the SPG9000, Management messages are used to broadcast synchronization metadata from the leader to its followers when the ST 2059-2 profile is used. See [Synchronization Metadata](#).

Signaling

Signaling messages carry information, requests, and commands between PTP instances. For the SPG9000, Signaling messages are used only for unicast negotiation. See [Unicast](#).

IEEE 1588-2019 also defines three other PTP message types (Pdelay_Req, Pdelay_Resp, and Pdelay_Resp_Follow_Up) that are used for the peer-to-peer delay mechanism. These are not used by the SPG9000; it only utilizes the end-to-end delay mechanism.

Domains

A PTP domain is a set of PTP instances that are synchronized to the grandmaster of the domain. The domain number is used to identify all the devices within this set.

Multiple domains may coexist on the same physical network. For example, on a given network, one leader and several followers can use domain 100 and a second leader and its followers use domain 101. The two domains are completely independent and can use different communication models and profiles if needed, such as ST 2059-2 for

media devices and AES67 for audio-only devices. With two PTP instances, the SPG9000 can be configured to use two different domains simultaneously.

Clock Types and Modes of Operation

PTP defines three types of clock devices:

Ordinary Clock: This is a PTP instance that has a single port in its domain. Both PTP instances of the SPG9000 are always Ordinary Clocks, as are PTP-capable audio-visual devices such as cameras or microphones.

Boundary Clock: This is a PTP instance that has multiple ports in its domain. This is typically a PTP-capable network switch in which one port is a follower to a leader and the other ports are leaders to followers. Boundary Clocks are frequently used—and strongly recommended—in larger broadcast and media networks.

Transparent Clock: This is a PTP instance (typically a PTP-aware network switch) that does not function as a leader or a follower but instead updates the time information in PTP messages that it forwards.

An Ordinary Clock may be constrained to only function in one of three modes:

Leader Only: The instance either serves as the grandmaster for the domain or it is a passive leader, ready to take over as the active grandmaster if the BMCA determines that it should.

Follower Only: The instance only synchronizes with a separate leader within the domain. If no leader is available, the instance listens for a new leader.

Ordinary Clock: The instance can adapt to network conditions and either follow a higher priority leader or it can become the leader for the domain.

Most media networks utilize a strict hierarchy with Leader Only devices serving as the active grandmaster or as passive backup leaders, and Follower Only devices at the network edge. However, there are situations where the unconstrained Ordinary Clock mode is very useful.

For example, a large live stadium event may require multiple mobile production units, and accurate time from a GNSS signal may not be available in some vehicles. The SPG9000 in one vehicle can be set to Ordinary Clock mode and locked to a grandmaster in another vehicle that does have a GNSS time source. If that GM is dropped from the network, the Ordinary Clock can become the new leader and assume the GM role for the domain. Its time is continuous from the previous GM time source, even without the availability of a direct time source from GNSS.

Best Master Clock Algorithm

The Best Master Clock Algorithm (BMCA) is the mechanism PTP instances use to determine which of the potential leaders should be the active leader. PTP instances do not negotiate which instance should be the active leader; instead, they each independently use the BMCA to arrive at the same result.

The BMCA uses information sent by each leader in Announce messages. These values are compared across all leaders to determine the best leader. The comparisons are made in a specific order:

- 1. Priority 1** is a user-configurable number in the range 0-255. Priority values must be in the range 0-128 for the instance to become an active leader. Because this value is considered first by the BMCA, it takes precedence over all other values. This can force a device to be the active leader even if its clock is not the most accurate. Therefore, Priority 1 values are typically set to the same number (for example 128) for all potential leaders in the domain, to let clock quality metrics determine the best leader. More complex networks can use Priority 1 to define a specific fail-over sequence. For example, the SPG9000 grandmasters are configured with Priority 1 of 10, spine switches (Boundary Clocks) are configured with Priority 1 of 20, and leaf switches (also Boundary Clocks) are configured with Priority 1 of 30.
- 2. Clock Class** is a number that indicates the current state and performance of the time and frequency source. Specific values are listed in Table 4 of IEEE 1588-2019. For example, the SPG9000 uses class 6 when it is locked to a GNSS signal and class 7 when it is in holdover mode after GNSS signal loss. A lower Clock Class number is better for BMCA purposes, so in this example an SPG9000 that is locked to GNSS is better than an SPG9000 currently in holdover mode.
- 3. Clock Accuracy** is a number that represents a conservative estimate of the expected accuracy of the clock. Specific values are listed in Table 5 of IEEE 1588-2019. For example, when the SPG9000 is locked to a GNSS signal, it uses a Clock Accuracy value of 0x21 (hex), which corresponds to an estimate of “within 100 ns”. If the SPG9000 is in holdover mode after GNSS signal loss, the Clock Accuracy changes to 0x26, or “within 25 μ s”.
- 4. Variance, or Offset Scaled Log Variance**, is an estimate of the inherent precision of the timestamps generated by the local clock. The SPG9000 uses a conservative value of 14848 for the Offset Scaled Log Variance value that is included in its Announce messages, which corresponds to a variance measurement of about $8.5 \times 10^{-22} s^2$.
- 5. Priority 2** is the second user-configurable number used by the BMCA. This value is typically used to designate primary, secondary, etc. leaders in a network with multiple leaders. The Priority 2 number is also in the range 0-255 (with a default of 128), with lower numbers representing higher priorities.
- 6. Clock Identity** is the final tie-breaker when comparing PTP instances using the BMCA. Because the Clock Identity is created from the MAC address of the instance network interface, and MAC addresses are unique within a network, the Clock Identity of two devices should never be the same.

The Clock Class, Clock Accuracy, and Offset Scaled Log Variance values are collectively called the Clock Quality.

Dynamic Priority

The SPG9000 includes a mechanism to control the behavior of the BMCA by dynamically adjusting the Priority 1 or Priority 2 value during normal operation. Dynamic Priority is useful to avoid grandmaster changes that might not be necessary.

Consider two SPG9000 systems, called “primary” and “backup” for the purpose of this example. Each is configured as a PTP leader with a GNSS reference source. The BMCA will choose one SPG9000 (primary) to be the active leader, by the lower Clock Identity value if all else is equal. If the GNSS signal is lost on the active leader, its Clock Class would change from 6 to 7 as the SPG9000 went into holdover mode. The BMCA would choose the backup SPG9000 to be the new active leader because its Clock Class is still 6. This is all expected and desired behavior.

However, when the GNSS signal is restored for the primary SPG9000 and holdover recovery completes, that leader would change its Clock Class back to 6. At that time, the BMCA would select the primary SPG9000 as the active leader, just as it was before the previous grandmaster change to the backup.

Strictly speaking, the second grandmaster change was not necessary, because both primary and backup SPG9000s are synchronized to the same GNSS signal and both have the same clock class. In some environments, it might be desirable to maintain the backup as the active leader and avoid the second GM change. Some ST 2110 systems might interrupt active IP connections when the GM is changed.

The SPG9000 can use Dynamic Priority mode to automatically adjust the Priority 1 or Priority 2 values in response to grandmaster changes, to prevent subsequent GM changes. The current priority value of the active leader is the configured (base) priority minus a configurable offset. The current priority of all passive leaders is the base priority with no offset applied.

For example, the primary leader is initially configured with a Priority 2 value of 100, the backup leader has a Priority 2 value of 101, and the dynamic offset is set to 2. When the leaders begin operation, the primary leader will become active since it has the better priority (lower number):

Leader	State	Clock Class	Priority 2
Primary	Active	6	100
Backup	Passive	6	101

At that point, the offset is applied to the active leader, so the new priorities are:

Leader	State	Clock Class	Priority 2
Primary	Active	6	98 (100 - 2)
Backup	Passive	6	101

Upon GNSS signal loss on the primary SPG9000, its Clock Class changes and the backup assumes the active leader role. Since the primary leader is no longer active, its Priority 2 resets to the base value.

Leader	State	Clock Class	Priority 2
Primary	Passive	7	100
Backup	Active	6	101

As before, the active leader then applies the dynamic offset:

Leader	State	Clock Class	Priority 2
Primary	Passive	7	100
Backup	Active	6	99 (101 - 2)

When the GNSS signal returns for the primary SPG9000, its Clock Class changes. But since the backup SPG9000 has a better Priority 2 (lower number), it remains the active leader.

Leader	State	Clock Class	Priority 2
Primary	Passive	6	100
Backup	Active	6	99 (101 - 2)

At a later time, if there is a GNSS signal loss to the backup, then the process will repeat in reverse and the primary GM will again become active. The two SPG9000s can operate indefinitely without intervention. The active leader will be determined by the Clock Class, and will not switch unnecessarily.

At a convenient time, you can manually reset the Dynamic Priority on the active leader, which will remove the dynamic offset and allow the PTP clocks to apply the BMCA and choose the best lead clock. Normally, this will result in a GM change back to the primary SPG9000.

After a GM becomes active, it will wait for an interval before applying the dynamic offset. This is necessary to allow all the potential GMs time to apply the BMCA and ensure the best GM has been chosen. The length of this delay is the announce period multiplied by the announce timeout count, multiplied by 2.

This example explains a use case for dynamic priority using priority 2. There are also use cases for dynamic priority for priority 1. Some of these use cases involve GMs that are not locked to a reference such as GNSS, but are in internal or Ordinary Clock mode.

Communication Models

PTP can operate over several types of networks. The SPG9000 only uses Internet Protocol version 4 (IPv4) for message transport.

PTP messages are carried by User Datagram Protocol (UDP) packets using port 319 for event messages (Sync and Delay_Req) and port 320 for general messages (Announce, Follow_Up, Delay_Resp, Management, and Signaling).

Depending on the profile and mode, PTP can use one of three different communication models:

Multicast

Using IPv4 multicast, multiple hosts on the local network receive all messages destined for the multicast group address. Hosts use the Internet Group Management Protocol (IGMP) to join or leave specific multicast groups. The multicast group address for PTP is 224.0.1.129.

With full multicast operation, the leader can send one Announce, Sync, or Follow_Up message to the multicast group address and it is received by all followers. However, every exchange of Delay_Req and Delay_Resp messages between each follower and the leader is received by all instances.

The multicast communication model is the simplest model from a configuration perspective. A follower simply joins the PTP multicast group and it discovers the leader from the Announce messages it receives.

The leader sets the rate for the Announce and Sync messages that it sends. The leader also includes the maximum allowed Delay_Req message rate as a parameter within the Delay_Resp message. Ideally, the follower uses that value to set its Delay_Req message rate. This rate is typically the same as the Sync message rate.

Because any potential leader in a network receives multicast Announce messages from the active leader, it can use the BMCA to determine if it is better. If so, it sends its own Announce messages and transitions from passive to active state. The previous active leader also receives the new Announce messages and also concludes that it is no longer the best leader. It stops sending Announce messages and transition to the passive state.

Unicast

Unicast operation is the usual method of point-to-point communication on IP networks, but for PTP there is additional configuration and additional complexity. Each follower is required to be configured with the Unicast Discovery List of the set of possible leaders.

When a unicast follower starts operation, it first sends a Signaling message to each address in the Unicast Discovery List. This message includes type-length-value (TLV) parameters to request the leader start sending Announce messages to the follower.

The leader may grant or deny the request. If denied, the follower can try again by sending a new request with a slower message rate.

After the follower starts receiving Announce messages from one or more leaders, it uses the BMCA to determine the preferred leader. It then sends additional Signaling messages to that leader with TLVs to request the leader send Sync and Delay_Resp messages at the requested rates. Again, the leader might grant or deny those requests and the follower can try again with slower message rates. When the follower starts receiving Sync and Delay_Resp messages, it can synchronize with the leader clock.

Leaders using the unicast model do not communicate with each other. Therefore, the leaders do not use the BMCA and are in the active state as long as they are serving followers that have grants for Announce, Sync, and Delay_Resp messages.

If the unicast communication model is used, all PTP instances in the domain must use unicast. If the followers in the network do not have the same set of leaders in their respective Unicast Discovery Lists, they may choose different leaders. It is important to configure all unicast followers the same way.

Mixed Multicast/Unicast

Mixed mode utilizes multicast for Announce, Sync, Follow_Up and Management messages and unicast for Delay_Req and Delay_Resp messages. This mode minimizes the message processing load for leaders, so they can support a larger number of followers. The mode also reduces the message processing load for followers because each one does not have to receive and discard the Delay_Req and Delay_Resp messages from the other followers. Multicast is used for messages that can be shared among all followers. Unicast is used for one-to-one messages.

A mixed mode follower does not need to be configured with a Unicast Discovery List. It receives Announce messages from the leader and it can extract the IP address from the Announce message for the unicast destination address for subsequent Delay_Req messages. Mixed mode also does not require unicast negotiation.

The multicast and mixed multicast/unicast communication models may co-exist in the same domain. Followers can use either model and leaders must support both. A leader responds to received Delay_Req messages using the same model for the Delay_Resp message.

Mixed mode does not provide any advantage in a network that uses switches in Boundary Clock mode, because each port of the Boundary Clock is a leader with only one follower.

Profiles

A PTP profile is a set of features, constraints, and parameter values that are used for a PTP instance. Profiles are published by various organizations to suit the needs for their specific applications. The SPG9000 supports three profiles:

SMPTE ST 2059-2

Profile name	SMPTE profile for synchronization in a professional broadcast environment
Version	1.0
Profile identifier	68-97-E8-00-01-00
Organization	Society of Motion Picture and Television Engineers
Specification	SMPTE ST 2059-2:2021 (section 6)

AES67

Profile name	PTP profile for media applications
Version	1.0
Profile identifier	00-0B-5E-00-01-00
Organization	Audio Engineering Society Standards Committee
Specification	AES67-2018 (Annex A)

IEEE 1588-2019 Default

Profile name	Default delay request-response profile
Version	1.0
Profile identifier	00-1B-19-01-01-00
Organization	IEEE Precise Networked Clock Synchronization Working Group of the IM/ST Committee
Specification	IEEE Std 1588-2019 (Annex I.3)

Each profile includes a set of mandatory, optional, and prohibited PTP features; default values and permissible ranges for several PTP attributes and parameters; and other profile-specific behavior.

For the SPG9000 PTP instances, the profile-specific differences are:

- The SMPTE profile includes support for the SM TLV in Management messages. The grandmaster sends a Management message once per second and whenever its locking status changes. Each follower can use the TLV information to adjust its time code outputs. See [Synchronization Metadata](#).
- The Mixed Multicast/Unicast communication model is not available with the AES67 profile, only full multicast or full unicast.

- Parameters such as Announce and Sync message intervals have different default values and permissible ranges. See [Set Profile Parameters to Default](#).

Synchronization Metadata

The ST 2059-2 specification defines how a grandmaster can share metadata with its followers so they can generate time code outputs consistent with each other and with PTP time. The Synchronization Metadata (SM) TLV includes parameters such as the system frame rate (for example 25 fps for PAL-based time code outputs and 29.97 fps for NTSC-based time code outputs), the offset between TAI time and local time, and the time of the next daily jam sync. See [Daily Jam Sync](#).

On the SPG9000, a PTP instance configured as a leader with the ST 2059-2 profile sends Management messages with the SM TLV once every second. These messages can be sent as multicast messages for the multicast or mixed communication models, or as unicast messages to each follower for the unicast model.

Most SM TLV parameters are automatically inserted based on other configuration settings and the current state. For example, the Local Offset is calculated from the time zone offset (configured from the Time tab or front-panel menu), the current DST offset, and the difference between TAI and UTC (37 seconds). The Next Jam Time is calculated from the Jam Sync Scheduled Time converted to TAI time.

See [SMPTE Synchronization Metadata](#) for the user-configurable SM TLV parameters for the leader. See [Details of Follower PTP Status](#) for a description of the decoded SM TLV.

Asymmetric Delay Compensation

Asymmetric delay compensation allows correcting the follower timing for any asymmetric delay in the network. If the network only uses PTP-aware switches (Boundary Clocks or Transparent Clocks), delay asymmetry is typically not a problem.

Several factors can cause the propagation delay for PTP messages to be different for the leader-to-follower direction than the follower-to-leader direction. Unless corrected, this propagation delay asymmetry will cause an offset in the clock phase that will be equal to half of the difference of the two path delays.

There are five main causes of asymmetric delay:

- **Rate mismatch** in a switch is when two ports operate at different line speeds (for example 1 Gbps and 10 Gbps). In this case delay asymmetry occurs because of the effects of message processing; the entire message must be stored in a buffer before it is forwarded from the switch on the output port.
For example, using a 1 Gbps input port and a 10 Gbps output port, the switch must wait for the entire message to clock in at the slower rate before it can start outputting the message at the higher rate. Conversely, with a 10 Gbps input port and a 1 Gbps output port, the entire packet is received at the faster rate and the output can start sooner (but at a slower rate).
Although the total transit time is the same for both directions, the delay on the fast-in, slow-out direction is shorter for the packets which contain the PTP timestamps.

This effect is more significant at lower port speeds, such as the mismatch between 100 Mbps and 1 Gbps ports.

If the switch can operate as a Transparent Clock or Boundary Clock, the rate mismatch delay effect is corrected by the switch.

- **Traffic mismatch** between the two paths occurs when there is significantly higher traffic utilization on one path than on the other. PTP message processing may be delayed because the switch is busy processing other types of traffic. This effect can be quite large depending on the amount of traffic, the quality of the switch, and the number of switches in the network.
Transparent Clock switches insert residence time information to allow the follower to correct for this delay, and Boundary Clock switches correct for traffic mismatch effects because the switch port is a new leader for its follower or followers. Also, switches that support Differentiated Services give PTP Event messages priority over most other traffic types. See [DiffServ Code Points](#).
- **Route path difference** can happen if the leader-to-follower path takes a different route in the network than the follower-to-leader path. This is uncommon in local area networks, but it is not uncommon when PTP is used over wide area networks.
- **Message type mismatch** may happen when using the mixed multicast/unicast communication model. Some switches may process multicast Sync messages differently than unicast Delay_Req messages.
- **Cable delay variation** occurs when the propagation delay through the cable is different in one direction than the other. In electrical network cable, such as Category 5 cable, it can be due to the twist rate on the pairs, routing inside the sheath, or material differences. With optical fiber it is primarily due to cable length differences for the two strands.

See [Delay Asymmetry](#) for how to set the delay asymmetry correction factor for the follower instance.

PTP Configuration

Most PTP configuration parameters are set from the PTP tab of the web interface or by pressing the PTP button on the front-panel interface, but the network interface settings are configured from the System tab of the web interface or the SYSTEM : NETWORK menu of the front-panel menu.

Web Interface for Network Settings

On the web interface, click the **System** tab and then click **Network Settings**.

Network Settings

Addresses									
	Enable	SFP Module	Port Speed	RS-FEC	MAC Address	DHCP	IPv4 Address	Subnet Mask	Gateway
PTP 1	<input checked="" type="checkbox"/>	10 Gbps / 850 nm	10 Gbps	<input type="checkbox"/>	00-90-56-01-10-01	<input checked="" type="checkbox"/>	Waiting for DHCP	Waiting for DHCP	Waiting for DHCP
PTP 2	<input checked="" type="checkbox"/>	Not Installed	Auto	<input type="checkbox"/>	00-90-56-01-0f-ab	<input type="checkbox"/>	172.16.2.50	255.255.255.0	172.16.2.1
IP 1	<input checked="" type="checkbox"/>	25 Gbps / 850 nm	Auto	<input type="checkbox"/>	00-90-56-17-41-60	<input type="checkbox"/>	172.16.3.50	255.255.255.0	172.16.3.1
IP 2	<input checked="" type="checkbox"/>	25 Gbps / 850 nm	Auto	<input type="checkbox"/>	00-90-56-17-41-61	<input type="checkbox"/>	172.16.4.50	255.255.255.0	172.16.4.1

DiffServ Code Points (DSCP)			
	PTP Event	PTP General	RTP
PTP 1	EF (46)	DF (0)	
PTP 2	EF (46)	DF (0)	
IP 1			AF41 (34)
IP 2			AF41 (34)

Apply Changes Cancel Changes

Front-Panel Menu for NETWORK

To use the front panel of the SPG9000 for this process, press **SYSTEM** and then select the **NETWORK** option. See [Menu Operations](#) for details of using the front-panel menus. The table shows the NETWORK menu, and submenus for PTP 1 and PTP 2.

SYSTEM :

PRESET :

INFO :

NETWORK :

MGMT :

PTP 1 :

PORT

SPEED

DHCP

IP ADDRESS

SUBNET MASK

GATEWAY

MAC ADDRESS

DSCP (PTP Event)

DSCP (PTP General)

PTP 2 :

Same menu and submenus as PTP 1

IP 1 :

IP 2 :

FRONT PANEL :

WEB :

GENERAL PURPOSE INTERFACE :

POWER SUPPLY :

FIRMWARE UPGRADE
CALIBRATE OVEN
DIAGNOSTICS

Configuration Settings for PTP Network Interfaces

Before configuring PTP instance settings, check that the network interfaces for the two ports are configured appropriately for the network. The factory default settings are IPv4 addresses of 172.16.1.50 for PTP 1 and 172.16.2.50 for PTP 2. These almost certainly need to be changed for the local network.

Enable

Check this box to enable the network interface. This setting is distinct from the PTP Instance Enable selection (see [Instance](#)) because it is possible to enable the network interface but disable the PTP instance. In that case, the network interface would respond to ping messages but would not respond to PTP messages.

SFP Module

This is a read-only status of the SFP module. This is only displayed on the web interface. If no SFP module is detected, “Not Installed” appears in the status. If the interface is enabled, this text is red to highlight the error condition,

If an SFP module is detected, the status indicates the interface speed and the laser wavelength, if applicable. For example, this can help identify mismatches between short-reach (850 nm) and long-reach (1310 nm) transceivers on the SPG9000 side and the switch side of the link.

Port Speed

Selects the data rate of the network port. The **Auto** selection will select the most appropriate speed based on parameters read from the SFP module. In some cases, such as when Direct Attach Cables (DACs) are used, the port speed may not be available from SFP data. Select **1 Gbps** or **10 Gbps** to manually set the desired port speed.

MAC Address

This is a read-only value of the physical address of the network interface. The first three octets of a MAC address indicate an Organizationally Unique Identifier (OUI), to help identify equipment on the network. The OUI for Telestream is 00-90-56, so the MAC addresses always begin with these three octets.

The MAC address is also used to create the PTP clock identity, as seen on the PTP status (see [Clock Identity](#)). The OUI is followed by hexadecimal values of FF FE, followed by the three remaining digits of the MAC address. For example, a MAC address displayed as 00-90-56-01-10-01 in the network interface configuration would appear as a PTP clock

identity of 00:90:56:FF:FE:01:10:01. This makes it easier to identify SPG9000 units in the PTP network. The OUI for Tektronix is 08-00-11, so earlier SPG8000A units (Tektronix manufacture) use a clock identity starting with 08:00:11:FF:FE and recent SPG8000A units (Telestream manufacture) use a clock identity starting with 00:90:56:FF:FE.

DHCP

Check this box to enable Dynamic Host Configuration Protocol (DHCP) on the interface. In this case, a DHCP server must be present on the network and it assigns the IPv4 address, subnet mask, and gateway address. If the user enables DHCP, manual configuration of those values is disabled but the values provided by the DHCP server are displayed.

IPv4 Address

Enter the four octets of the IPv4 address, in dotted decimal notation. On the front-panel interface, an edit menu (see [Edit Menus](#)) is used to enter the address, using three digits for each octet with leading zeros if necessary. For example, an address displayed as 192.168.1.50 on the web interface appears as 192.168.001.050 on the front-panel interface. If DHCP is enabled, the IPv4 address supplied by the DHCP server is displayed instead and cannot be edited.

Subnet Mask

Enter the four octets of the subnet mask, in dotted decimal notation. If DHCP is enabled, the subnet mask supplied by the DHCP server is displayed instead and cannot be edited.

Gateway

Enter the four octets of the gateway address for this subnet, in dotted decimal notation. If DHCP is enabled, the gateway address supplied by the DHCP server is displayed instead and cannot be edited.

Note: When setting up connections and network addresses for the PTP and IP ports, care should be taken to isolate the ports. The default settings for the address, subnet mask, and gateway put the four ports on different subnets. If the ports are configured to use the same subnet, then ARP message responses may be sent on a different port than the port from which the ARP request was received. This can confuse the routing of signals.

Do not connect the ports to separate physical networks reusing the same addresses. This configuration results in inherently ambiguous unicast routing and requires advanced routing configuration to work correctly.

For multicast traffic, keeping the ports isolated does not cause an issue. The multicast packets will traverse across subnets so PTP and IP traffic will be unaffected. For unicast

and mixed mode PTP using layer 2 routing, the source and destination must be in the same subnet. This may impose some restrictions on how the networks are designed.

In a PTP network using boundary clocks, it is easy to set up each point-to-point link from the switch to the SPG9000 on a narrow subnet, such as using a 30-bit subnet mask. This should make it easy to define different address ranges for the two PTP ports.

DiffServ Code Points

Select the DSCP values for PTP Event messages and PTP General messages.

Differentiated Services (DiffServ) is a mechanism for applying quality of service (QoS) to IP networks. A DiffServ Code Point (DSCP) is a 6-bit value (between 0 and 63) that is included in the header of an IP packet. It identifies the type of traffic and its associated priority.

PTP messages types are grouped into two message classes:

- **Event** messages include Sync and Delay_Req.
- **General** messages include Announce, Follow_Up, Delay_Resp, Management, and Signaling.

PTP Event messages typically use the Expedited Forwarding (EF) class, which is intended for low-loss and low-latency traffic. EF is assigned a DSCP value of 46. It is important for the timestamp of transmitted Sync and Delay_Req messages to be as accurate as possible; this is why Event messages use a higher priority class.

PTP General messages can simply use the Default Forwarding (DF) class for best-effort traffic, which has a DSCP value of 0.

Apply Changes

Click to accept any changes made to the network settings since opening the panel on the web interface.

Cancel Changes

Click this button to cancel any changes made to the network settings and restore the previously saved settings.

Web Interface for PTP Instances

On the web interface, click the **PTP** tab for the configuration menus for the two instances. When the tab is first opened, the two sections labeled "PTP 1" and "PTP 2" are collapsed:

Status	Reference	Time	PTP	Black	LTC	System
> PTP 1	Follower Only	Mixed Multicast/Unicast	Domain: 120			
> PTP 2	Leader Only	Both Multicast and Mixed	Domain: 121			

The section headers for PTP 1 and PTP 2 each show a summary of the current configuration, displaying the selected mode, communication model, and domain number. This makes it easy to view the configuration of both instances together, in a table-like format. Click on a header to open that section to see the menus for that PTP instance.

The menus available for a PTP instance depend on the selected Mode, Profile, and Communication Model as noted. For example, the menus available for a Follower Only instance using the mixed multicast/unicast model are:

> PTP 2
Follower Only
Mixed Multicast/Unicast
Domain: 120

Instance Enable

Mode Follower Only ▾

Header Version 2.0 ▾

Profile SMPTE ST 2059-2 ▾
Set Profile Parameters to Default

Communication Model Mixed Multicast/Unicast ▾

Domain 120

Max Steps Removed 255

Delay Asymmetry 0 µs

Messages

Announce Timeout 3

The menus available for a Leader Only instance using the SMPTE profile are:

The screenshot shows the configuration interface for PTP 1. At the top, there are tabs for 'Leader Only' (selected), 'Both Multicast and Mixed', and 'Domain: 121'. The main configuration area includes:

- Instance:** Enable
- Mode:** Leader Only (dropdown)
- Header Version:** 2.0 (dropdown)
- Profile:** SMPTE ST 2059-2 (dropdown) with a 'Set Profile Parameters to Default' button.
- Communication Model:** Both Multicast and Mixed (dropdown)
- Domain:** 121 (text input)

Below these are three sections:

- Priority:** Priority 1 (128), Priority 2 (128), Dynamic Priority (Priority 2 dropdown), Dynamic Offset (2). An 'Applied: 126' label and a 'Restore' button are also present.
- Messages:** Announce Interval (1 s (1 Hz) dropdown), Announce Timeout (3), Sync Interval (125 ms (8 Hz) dropdown).
- SMPTE Synchronization Metadata:** Video Frame Rate (29.97 dropdown), Drop-Frame Flag (Enable dropdown), Color Frame ID Flag (Enable dropdown).

Front-Panel Menu for PTP Instances

To use the front panel of the SPG9000 for this process, press **PTP** repeatedly to alternate between the two instance submenus and then press **ENTER** for the selected instance. See [Menu Operations](#) for details of using the front-panel menus. The table shows the menus and submenus for PTP 1 and PTP 2.

PTP 1 :

INSTANCE	
MODE	
HEADER VERSION	
PROFILE	
COMMUNICATION MODEL	
DOMAIN	
PRIORITY 1	Not available for Follower Only mode
PRIORITY 2	Not available for Follower Only mode
DYNAMIC PRIORITY	Not available for Follower Only mode
DYNAMIC OFFSET	Not available for Follower Only mode
MAX STEPS REMOVED	Not available for Leader Only mode
DELAY ASYMMETRY	Not available for Leader Only mode

MESSAGES :	
ANNOUNCE INTERVAL	Not available for Follower Only mode for multicast and mixed models
ANNOUNCE TIMEOUT	
SYNC INTERVAL	Not available for Follower Only mode for multicast and mixed models
SMPTE SYNC METADATA :	Only available for Leader Only or Ordinary Clock modes and ST 2059-2 profile
Video Frame Rate	
Drop-Frame Flag	
Color Frame ID Flag	
UNICAST DISCOVERY LIST :	Only available for Follower Only or Ordinary Clock modes and Unicast communication model
IP 1 - IP 8	
PTP 2 :	Same menus as PTP 1

Configuration Settings for PTP Instances

The PTP Instances section on the Status tab contains information about the current reference source, the genlock input signal, and the received GNSS signal.

Instance

Check this box to enable the PTP instance. When disabled, the instance does not send or receive any PTP messages on the network interface. It may still respond to “ping” messages if the port is enabled but the instance is disabled. See [Enable](#).

Mode

Selects the operational mode of the PTP instance. See [Clock Types and Modes of Operation](#).

Leader Only: The instance only functions as a leader for this domain. It can be in the Active state, in which case it is the current grandmaster (GM), or it can be in the Passive state, in which case another leader in this domain is the current GM.

Follower Only: The instance only functions as a follower in this domain. If one or both of the PTP instances are configured as follower, the reference source for the instrument can be set to PTP Follower. See [Configuration Settings for Reference](#). If a follower instance is not used for the reference source, it can still lock to a leader for the domain and report its status information. See [PTP Status](#).

Ordinary Clock: The instance can function either as a leader or a follower, depending on network conditions. When the BMCA selects this instance, it assumes the Active leader role. But unlike a Leader Only instance that assumes a passive role when the BMCA selects another leader, an Ordinary Clock assumes a follower role and tracks the active leader.

Note: Do not configure both PTP instances of the same SPG9000 to use Ordinary Clock mode with a reference source of PTP Follower. This might lead to a “loop” whereby the instrument is synchronized to itself, which is an unstable configuration.

If the reference source is set to GNSS Signal (Clock Class 6 or 7), an Ordinary Clock instance can never be in the follower state per the IEEE 1588 specification. It can only be an active leader or a passive leader. Therefore, it is simpler to use the Leader Only mode for a GNSS reference source.

Header Version

Selects the version number (2) and minor version number (0 or 1) that are signaled in the second octet of the header of all transmitted PTP messages. Version 2.0 refers to the 2008 revision of the IEEE Std 1588 specification and version 2.1 refers to the 2019 revision. Some PTP devices will not accept version 2.1 messages, so selecting 2.0 may mitigate some interoperability issues. The SPG9000 will operate equally with either 2.0 or 2.1 header version.

Note: This selection does not affect any operational behavior of the PTP instance. It only affects the value signaled in the header of transmitted PTP messages.

Profile

Selects the PTP profile for the instance. See [Profiles](#).

SMPTE ST 2059-2: The SMPTE profile is the preferred profile for professional networked media applications.

AES67: The AES67 Media profile is typically used for audio-only applications or for video applications that cannot process the management SM TLV messages used by the SMPTE profile.

IEEE 1588-2019: The IEEE profile is the default for use with the delay request-response mechanism.

Set Profile Parameters to Default

Click this button to reset certain parameters to the default values for the selected profile.

	SMPTE ST 2059-2	AES67	IEEE 1588-2019
Domain 0	127	0	0
Priority 1	128	128	128
Priority 2	128	128	128

	SMPTE ST 2059-2	AES67	IEEE 1588-2019
Announce Interval	1 s (1 Hz)	2 s (0.5 Hz)	2 s (0.5 Hz)
Announce Timeout	3	3	3
Sync Interval	125 ms (8 Hz)	125 ms (8 Hz)	1 s (1 Hz)

Communication Model

Selects the communication model used by the instance. See [Communication Models](#). The list of available models depends on the selected Mode and Profile.

Multicast: With the multicast model, all PTP messages between the leader and its followers use multicast addressing.

Unicast: With the unicast model, all PTP messages between the leader and each individual follower use unicast addressing. Followers must be preconfigured with a list of addresses of possible leaders.

Mixed Multicast/Unicast: With the mixed model, leaders use multicast addressing for Announce, Sync, Follow_Up, and Management messages (SMPTE profile). Followers use the address from the Announce message to send unicast Delay_Req messages to that leader. The leader sends the Delay_Resp message back to the follower using its unicast address. The mixed model is only available for SMPTE and IEEE profiles, and for the Follower Only mode.

Both Multicast and Mixed: This selection is only available for the SMPTE and IEEE profiles and for the Leader Only mode. Leaders are required to simultaneously support followers that use Multicast and followers that use Mixed Multicast/Unicast models.

Domain

Select the domain number for this PTP instance, within the range 0-127. See [Domains](#).

The default domain number is profile dependent; SMPTE uses 127, and AES and IEEE profiles use 0. We advise using a different domain number from the default to prevent improperly configured devices from assuming the grandmaster role.

Priority 1 and Priority 2

Enter the priority 1 and priority 2 values for the leader, which are used for BMCA decisions. See [Best Master Clock Algorithm](#). These menus are not available for Follower Only mode. Priority values of 0-255 may be entered, but values of 128-255 are used for devices that will not become active leaders.

Dynamic Priority

Select the Priority 1 or Priority 2 to enable Dynamic Priority mode for this PTP instance or select Off to disable Dynamic Priority mode. See [Dynamic Priority](#).

Restore

Click this button to remove the dynamic offset from an active leader's priority value and to reset the priority to its initial base value. When Dynamic Priority is in effect, the Applied value will be displayed next to the configured value. If no Applied value is displayed, the Restore button has no effect.

When the priority of the active leader is restored to its base value, the BMCA will select the new grandmaster for the current conditions. In most cases this will be the original top priority leader.

Dynamic Offset

Select the offset to be used for Dynamic Priority mode, between 2 and 10. The selected value must be large enough to accommodate the base priority values of all potential grandmasters in the domain. For example, if the base priority values for four leaders (two SPG9000s with two leaders each) are 10, 12, 14, and 16, then the dynamic offset must be at least 7 for the fourth leader to have the lowest value if it becomes active.

Note: Do not choose a base Priority 1 or Priority 2 value less than the Dynamic Offset value, because the priority value cannot be less than 0 if the leader becomes active.

Max Steps Removed

Enter the upper limit for the stepsRemoved value for Announce messages received from the leader. This menu is not available for Leader Only mode.

Steps removed refers to the number of steps or hops between the PTP instance and the grandmaster. Each Boundary Clock in a path counts as a step or hop. A follower with a path to the grandmaster that goes through a PTP-unaware switch or Transparent Clock has a step count of 1. If the switch is replaced with a Boundary Clock, the step count is 2.

If the stepsRemoved value in a received Announce message is greater than or equal to the Max Steps Removed value, that Announce message is ignored.

Delay Asymmetry

Enter the delay asymmetry value for the follower instance. See [Asymmetric Delay Compensation](#).

The value must be a floating point number of microseconds between -99.999 and $+99.999$ μs , with 0.001 μs (1 ns) resolution. A positive value means the leader-to-follower propagation time is longer than the follower-to-leader propagation time, and a negative value means the opposite. This menu is not available for Leader Only mode.

Announce Interval

Select the time interval between successive Announce messages transmitted by the leader. The available choices are described both in terms of the time interval and the corresponding message rate. For example, an interval of 2 seconds represents a message rate of 0.5 messages per second.

This menu is not available for Follower Only mode with multicast or mixed multicast/unicast communication models. For Follower Only mode with unicast communication model, the Announce Interval setting is the requested value sent to a leader in a grant request Signaling message. See [Unicast](#).

Announce Timeout

Select the maximum number of Announce messages that are missing before the PTP instance assumes the leader is no longer present. After that time, instances in the domain start the process of selecting a new leader by the BMCA.

It is a good practice to configure all devices in the domain with the same announce interval and timeout count so they all respond in a similar time-frame. For example, using the multicast communication model with an Announce interval of 1 second and a timeout count of 3, a passive leader starts sending its own Announce messages 3 seconds after the active leader stops sending Announce messages.

Sync Interval

Select the time interval between successive Sync messages transmitted by the leader. The available choices are described both in terms of the time interval and the corresponding message rate. For example, an interval of 125 milliseconds represents a message rate of 8 messages per second.

The Sync Interval has a significant effect on the lock time and stability of PTP followers. The SMPTE profile default value of 8 messages per second was chosen to provide a trade-off between PTP performance and network load. Most PTP devices are optimized for the default rates. If other rates are chosen, additional testing is necessary to ensure acceptable performance.

This menu is not available for Follower Only mode with multicast or mixed multicast/unicast communication models. For followers using the unicast communication model, the Sync Interval setting is the requested value sent to a leader in a grant request Signaling message. See [Unicast](#).

Unicast Discovery List

Enter the IP addresses of up to 8 potential leaders. Use a value of 0.0.0.0 for entries that are not used. See [Unicast](#) for more about the Unicast Discovery List. These menus are only available for the unicast communication model and the Follower Only or Ordinary Clock modes.

Unicast Discovery List			
1	10.1.1.10	2	10.1.1.11
3	10.1.1.12	4	0.0.0.0
5	0.0.0.0	6	0.0.0.0
7	0.0.0.0	8	0.0.0.0

To use the front panel for this process, see [Front-Panel Menu for PTP Instances](#).

SMPTE Synchronization Metadata

When the ST 2059-2 profile is used, the active leader sends Management messages with the SM TLV at a rate of one per second. See [Synchronization Metadata](#).

Most parameters of the SM TLV are automatically computed, but three are user-configurable. These menus are only available for Leader Only and Ordinary Clock modes with the SMPTE profile.

SMPTE Synchronization Metadata	
Video Frame Rate	29.97 ▼
Drop-Frame Flag	Enable ▼
Color Frame ID Flag	Enable ▼

To use the front panel for this process, see [Front-Panel Menu for PTP Instances](#).

Video Frame Rate

Select the frame rate for the video outputs of the follower. Interlaced formats typically refer to fields per second, so be sure to choose the frames-per-second value. For example, NTSC uses 59.94 fields per second, which is 29.97 frames per second.

Drop-Frame Flag

Select whether the drop-frame format should be enabled or disabled for the time code outputs of the follower. Normally this flag is only enabled for a video frame rate of 29.97 fps or 59.94 fps.

Color Frame ID Flag

Select whether color frame identification should be enabled or disabled for the time code outputs of the follower. The color frame flag appears in the LTC and VITC code words, according to ST 12-1.

Synchronization Outputs

The SPG9000 has multiple outputs that can deliver synchronization signals to downstream devices that genlock to the SPG. There are six outputs (BLACK 1 to BLACK 6) that can generate signals such as NTSC or PAL black burst or HD tri-level sync. Four linear time code outputs (LTC 1 to LTC 4) can distribute time code to the facility. Two more outputs deliver audio reference signals: Word Clock and Digital Audio Reference Signal (DARS).

Black Outputs

The SPG9000 includes six outputs labeled BLACK 1 to BLACK 6, which can be configured for a variety of analog synchronization signal formats.

Web Interface for Black

On the web interface, click the **Black** tab for the configuration menus for the six outputs. When the tab is first opened, the six sections labeled Black 1 to Black 6 are collapsed:



Below these six output sections is an additional menu section to select the available frame rates for any outputs configured for HD tri-level sync formats. See [HD Tri-Level Frame Rate](#).

The section headers for Black 1 to Black 6 each show a summary of the current configuration, displaying the selected format and timing offsets. This makes it easy to

view the configuration of all outputs at one time, in a table format. Click a Black header to open that section and see the menus for that output.

▼ **Black 4** **NTSC** **Timing: 0 lines, 0.0000 μs** **VITC: Local (DST)**

Output

Format NTSC ▼

Field Reference Enable

10-Field Sequence ID Enable

Timing

Vertical Delay 0 lines

Horizontal Delay 0 μs 0 ns

Vertical Interval Time Code

Source Local (DST) ▼

Offset +00:00:00:00

Line Numbers 14 Enable 16 Enable

Drop-Frame (30 fps) Enable

Front-Panel Menu for BLACK

To use the front panel of the SPG9000 for this process, press **BLACK** repeatedly to select from the six output submenus and the two HD TRI-LEVEL SYNC RATE submenus. See [Menu Operations](#) for details of using the front-panel menus.

The table shows the submenus for the BLACK menu and the submenus for BLACK 1.

BLACK 1 :	
FORMAT	
FIELD REFERENCE	Only available if FORMAT is NTSC, NTSC-J, or PAL
10-FIELD SEQUENCE ID	Only available on Black 4-6 outputs and if FORMAT is NTSC or NTSC-J
TIMING :	Not available for 1 PPS format
Vertical	
Horizontal Coarse	
Horizontal Fine	
TIME CODE :	Only available if FORMAT is NTSC, NTSC-J, or PAL
SOURCE	
OFFSET	
DROP-FRAME	Only available if FORMAT is NTSC or NTSC-J
VITC 1	
VITC 1 LINE	

VITC 2**VITC2 LINE****BLACK 2-6**

Same menu options as Black 1

BLACK 1-3 : HD TRI-LEVEL SYNC RATE**BLACK 4-6 : HD TRI-LEVEL SYNC RATE**

Configuration Settings for Output

Configure the specific black output:

On the web interface, click the **Black** tab, and then click the specific Black section (1-6) to configure.

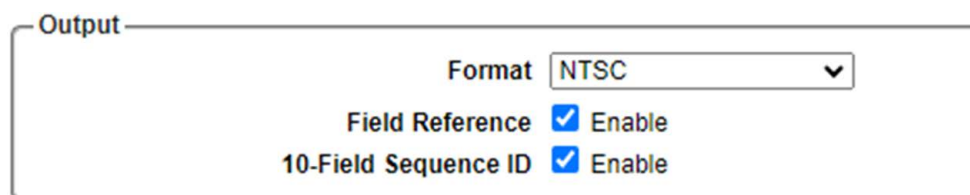

Output

Format

Field Reference Enable

10-Field Sequence ID Enable

To use the front panel for this process, see [Front-Panel Menu for BLACK](#).

Format

Selects the output format. The list of available formats in this menu is variable.

These formats are available on all outputs:

NTSC: Selects NTSC black burst (525 lines at 59.94 interlaced fields per second). The signal has a black level of 7.5 IRE, according to NTSC-M as used in North America and several other countries.

NTSC-J: Selects NTSC black burst with a black level of 0 IRE as used in Japan.

PAL: Selects PAL black burst (625 lines at 50 interlaced fields per second).

1 PPS: Selects a pulse-per-second signal. The signal level is 2 V for the Black 1-3 outputs and 5 V for the Black 4-6 outputs when unterminated. The signal levels are half those amplitudes into a 75 Ω termination.

This format is available on outputs 3-6, but not outputs 1-2:

CW 10 MHz: Selects a continuous wave (CW) signal with a frequency of 10 MHz and a signal level of 1.5 Vp-p.

The set of available HD tri-level sync formats depends on the selection in the Black Output HD Tri-Level Frame Rates menu. Either the set of non-integer rates or the set of integer rates is available for each of Black 1-3 and Black 4-6.

Frame Type	Non-Integer Rates	Integer Rates
Interlaced	1080 59.94i	1080 60i
		1080 50i
Progressive	1080 59.94p	1080 60p
		1080 47.95p
		1080 29.97p
		1080 23.98p
		720 59.94p
		720 50p
Segmented Frame	1080 23.98sF	1080 24sF

Field Reference

Check this box to enable the field reference signal. This menu is only applicable if the selected format is black burst (one of NTSC, NTSC-J, or PAL). When enabled, a 700 mV (white) signal appears for the complete active line duration on line 10 (NTSC) or line 7 (PAL) of field 1 only. This makes it easier to identify the first field in the 4-field (NTSC) or 8-field (PAL) sequence.

10-Field Sequence ID

Check this box to enable the 10-field sequence ID pattern as defined in ST 318M. This pattern is only defined for NTSC (and NTSC-J) and appears as a series of pulses on line 15 (odd fields) and line 278 (even fields). When enabled, the black output is aligned with Frame Reset 1 (2.997 Hz) and is therefore synchronized with other outputs that use this ID pattern. See [Epoch-Based Synchronization](#).

Note: This option is only available in outputs 4-6.

Configuration Settings for Timing

The Timing settings adjust the timing offset of the output signal relative to the internal frame reset. See [Epoch-Based Synchronization](#) to understand how frame resets are synchronized with respect to the reference source.

The total timing offset is a combination of whole lines (vertical delay) and partial lines (horizontal delay). A negative value means the internal clock is advanced relative to the frame reset.

On the web interface, click the **Black** tab, and then click the specific Black section (1-6) to configure.

The screenshot shows a 'Timing' configuration box. It contains two rows of controls. The first row is 'Vertical Delay' with a text input field containing '0' and the unit 'lines'. The second row is 'Horizontal Delay' with a spin button containing '0.0474' and the unit 'μs', followed by a text input field containing '0' and the unit 'ns'.

To use the front panel for this process, see [Front-Panel Menu for BLACK](#).

Vertical Delay

Enter an integer number of lines, in 1 line increments.

Horizontal Delay

Enter the horizontal delay values, the sum of a coarse value (in microseconds) and a fine value (in nanoseconds). Enter the horizontal coarse value in increments of the clock used for the output format. For NTSC and PAL, a 54 MHz clock is used so each coarse step is about 0.0185 μs. For HD tri-level sync formats, a 74.25 MHz clock (integer frame rates) or a 74.1758 MHz clock (non-integer frame rates) is used so each coarse step is about 0.0135 μs. Enter the horizontal fine value in increments of 0.1 ns.

The range of the timing adjustment depends on the selected signal format:

Format	Vertical (lines)	Horizontal Coarse (μs)	Horizontal Fine (ns)
NTSC and NTSC-J	± 525	± 63.5556	± 10.00
PAL	± 1250	± 64.0000	± 10.00
1080 60i	± 562	± 29.6296	± 7.00
1080 59.94i	± 562	± 29.6593	± 7.00
1080 50i	± 562	± 35.5556	± 7.00
1080 60p	± 562	± 14.8148	± 7.00
1080 59.94p	± 562	± 14.8296	± 7.00
1080 50p	± 562	± 17.7778	± 7.00
1080 48p	± 562	± 18.5185	± 7.00
1080 47.95p	± 562	± 18.5370	± 7.00
1080 30p	± 562	± 29.6296	± 7.00

Format	Vertical (lines)	Horizontal Coarse (μ s)	Horizontal Fine (ns)
1080 29.97p	± 562	± 29.6593	± 7.00
1080 25p	± 562	± 35.5556	± 7.00
1080 24p	± 562	± 37.0370	± 7.00
1080 23.98p	± 562	± 37.0741	± 7.00
1080 24sF	± 562	± 37.0370	± 7.00
1080 23.98sF	± 562	± 37.0741	± 7.00
720 60p	± 375	± 22.2222	± 7.00
720 59.94p	± 375	± 22.2444	± 7.00
720 50p	± 375	± 26.6667	± 7.00

Configuration Settings for VITC

Outputs configured to one of the black burst formats (NTSC, NTSC-J, or PAL) can also carry time code in the vertical blanking area of the video frame. Vertical Interval Time Code (VITC) on each output can use different time sources and independent offsets.

On the web interface, click the **Black** tab, and then click the specific Black section (1-6) to configure.

Vertical Interval Time Code

Source: Local (DST)

Offset: +00:00:00:00

Line Numbers: 14 Enable

Drop-Frame (30 fps) Enable

16 Enable

To use the front panel for this process, see [Front-Panel Menu for BLACK](#).

Source

Select the time source for the time code counter:

Disabled: No time code will be inserted in the video output signal.

Local (DST): Use the main time-of-day and the time zone offset and the daylight saving time offset to compute the local time.

Local (No DST): Use the main time-of-day and the time zone offset, but exclude any daylight saving time offset to compute the local time.

UTC: Use Coordinated Universal Time instead of a local time.

Program Time: Use the program time counter instead of a time-of-day value. See [Program Time Counter](#).

The VITC data includes the hours, minutes, seconds, and frames digits (in the format HH:MM:SS:FF) according to ST 12-1 and the year, month, day, and time zone information according to ST 309.

Offset

Enter a time offset (hours, minutes, seconds, and frames) relative to the selected source time. For example, you could use the time code for a different time zone than the system normal time zone by specifying an offset of ± 1 -or-more hours.

Line Numbers

Enter the required line numbers in the vertical interval and check the boxes to enable the lines. The SPG9000 can insert the VITC data into one or two different lines in the vertical interval. One line is always enabled; to disable VITC altogether, select **Disabled** from the **Source** menu. When two lines are enabled, they should be nonconsecutive lines.

According to ST 12-1, the preferred locations and limits for VITC are:

	NTSC	PAL
Preferred Line	14	19
Optional Line	16	21
Earliest Line	10	6
Latest Line	20	22

Drop-Frame (30 fps)

Check this box to enable drop-frame time code. This option is only available when the format is NTSC or NTSC-J. This option should be selected for most applications where the time code represents time-of-day; this is so the time code is similar to the real-time clock. See [Daily Jam Sync](#) for keeping 30 fps drop-frame time code aligned with the main time-of-day (MTOD).

Non-drop frame (NDF) time code is sometimes used in editing and post-production, typically when also using the Program Time source.

HD Tri-Level Frame Rate

The six black outputs of the SPG9000 are grouped into two sets (Black 1-3 and Black 4-6). In each group, any of the three outputs configured to HD tri-level sync formats must have an integer frame rate (30, 25, 24, etc.) or all have a non-integer frame rate (29.97, 23.98, etc.). If your application requires both 1080i 59.94 and 1080i 50 signals, for example, you must use any of Black 1-3 for one output and any of Black 4-6 for the other output. There are no restrictions on which outputs are NTSC or PAL.

On the web interface, click the **Black** tab, and then click the specific Black section (1-6) to configure.

Select either Integer Rates or Non-Integer Rates for Black 1-3 and Black 4-6.

Black Output HD Tri-Level Frame Rates

Black 1-3	Integer Rates (60, 50, 48, 30, 25, 24) ▼
Black 4-6	Non-Integer Rates (59.94, 47.95, 29.97, 23.98) ▼

To use the front panel for this process, see [Front-Panel Menu for BLACK](#).

Linear Time Code Input and Outputs

The SPG9000 has four sets of pins on the rear-panel LTC/GPI connector for LTC input and outputs. These can be configured as one input and three outputs, or as four outputs.

See [LTC/GPI Connector](#) for the connector pin diagram.

Web Interface for LTC

On the web interface, click the **LTC** (Linear Time Code) tab for the configuration menus for the four outputs. When the tab opens, the four sections LTC 1 through LTC 4 are collapsed as shown:

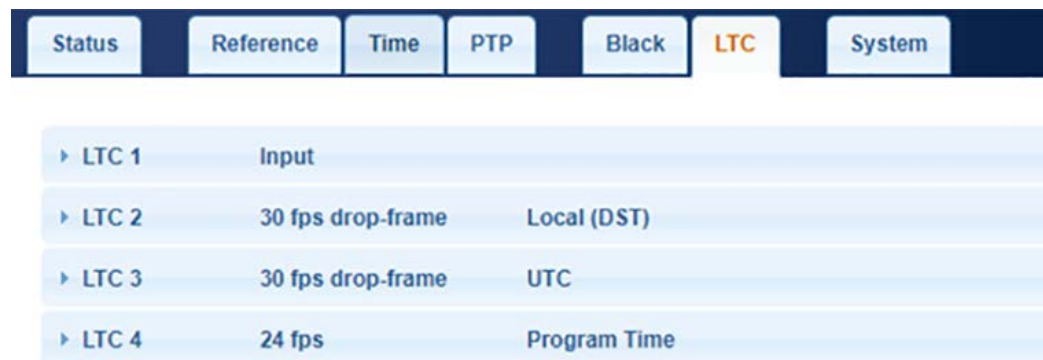

The section headers for LTC 1 to LTC 4 each show a summary of the current configuration, displaying the selected format and time source. This makes it easy to

view the configuration of all outputs at the same time, in a table-like format. Click on a header to open that section and see the menus for that output.

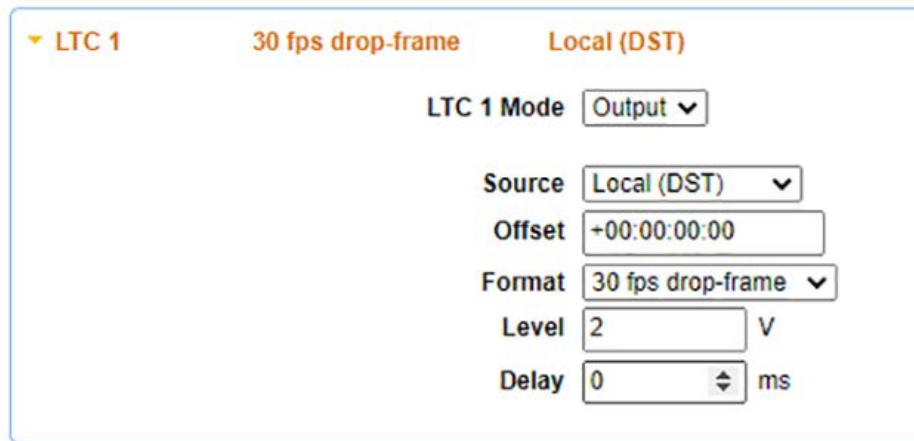

Front-Panel Menu for LTC

To use the front panel of the SPG9000 for this process, press **LTC** repeatedly to select from the four output submenus. See [Menu Operations](#) for details of using the front-panel menus.

The table shows the submenus for the LTC 1 menu.

LTC 1 :

MODE	Only available for LTC 1
FORMAT	
SOURCE	
OFFSET	
DELAY	
OUTPUT LEVEL	

LTC 2-4 :

Configuration Settings for LTC

These settings can be configured from both the web interface and the front-panel menus.

LTC 1 Mode

Select Output or Input for the LTC 1 pins on the rear panel connector. This menu is only available for LTC 1; LTC 2-4 are always configured as outputs. When LTC 1 is configured as an input, it can be used as a time-of-day source when the reference source is either Genlock Input or Internal. See [Configuration Settings for Time of Day](#).

Source

Select the time source for the time code counter:

Disabled: The LTC output is disabled.

Local (DST): Use the main time-of-day plus the time zone offset plus the daylight saving time offset to compute the local time.

Local (No DST): Use the main time-of-day plus the time zone offset, but exclude any daylight saving time offset to compute the local time.

UTC: Use Coordinated Universal Time instead of a local time.

Program Time: Uses the program time counter instead of a time-of-day value. See [Program Time Counter](#).

The LTC data includes the hours, minutes, seconds, and frames digits (HH:MM:SS:FF) according to ST 12-1 and the year, month, day and time zone information according to ST 309.

Offset

Enter a time offset (hours, minutes, seconds, and frames) relative to the selected source time. For example, you could use the time code for a different time zone than the system's normal time zone by specifying an offset of ± 1 or more hours.

Format

Selects the linear time code format and frame rate.

The LTC format refers to the allowed range of digits for the frame count, along with the method in which they are counted and roll over at the end of each second. For example, 24 fps time code counts frames from 00 to 23 each second, and then rolls over back to 00. 30 fps drop-frame time code counts frames from 00 to 29 in most seconds, but skips the 00 and 01 counts at specific times. See [Daily Jam Sync](#).

An LTC frame is the period over which the LTC codeword (80 bits long) is transmitted, aligned with the corresponding video frame. For example, a LTC frame rate of 25 fps results in an LTC signal with a bit rate of 2000 bps, with the start of each LTC frame aligned with the start of 25 fps video frames, such as PAL black outputs.

Select one of the LTC formats:

24 fps: Select 24 fps time code, with frames counted from 00 to 23 for every second.

25 fps: Select 25 fps time code, with frames counted from 00 to 24 for every second.

30 fps: Select non-drop frame time code, with frames counted from 00 to 29 for every second, at a frame rate of 30 fps.

30 fps drop-frame: Select drop-frame time code at a frame rate of 29.97 fps.

24 fps @ 23.98 Hz: frames are counted from 00 to 23 each second, but the frame rate is 23.98 fps. Five frames at this rate are aligned with four complete video frames at 29.97 fps.

Level

Enter the signal level for the LTC output. Valid values are from 0.5 V to 5.0 V in 0.5 V steps.

Delay

Enter the time offset (in milliseconds) by which the LTC frame will be delayed from its normal video frame alignment.

Audio Reference Outputs

The Word Clock output generates a simple 48 kHz square wave at an output level of $\pm 1.0\text{V}$ or 0-5 V.

The DARS (Digital Audio Reference Signal) output generates an AES3 digital audio signal that can be used as a synchronization reference for audio equipment.

Web Interface for Audio Reference Outputs

On the web interface, click the **Audio** tab, and then click **Reference Outputs**.

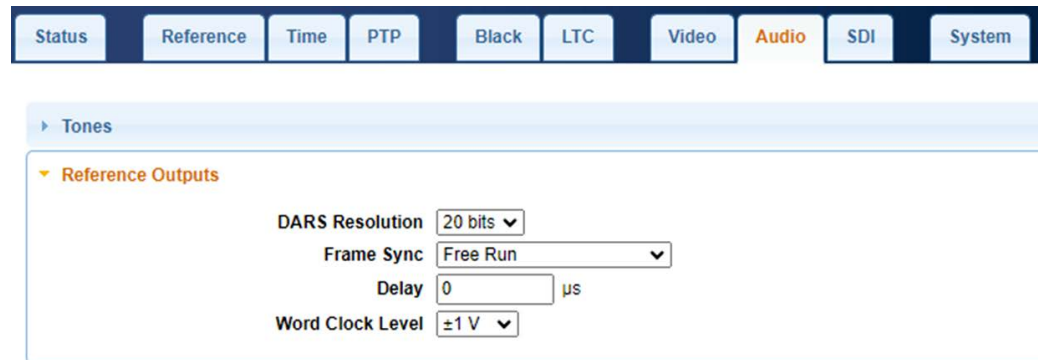

Front-Panel Menu for Audio Reference Outputs

To use the front panel of the SPG9000 for this process, press **AUDIO** and then select the **REFERENCE** option. See [Menu Operations](#) for details of using the front-panel menus.

The table shows the menus for AUDIO and the submenus for REFERENCE.

AUDIO :
 TONES :
REFERENCE :

DARS RESOLUTION
FRAME SYNC
DELAY
WORD CLOCK LEVEL

Configuration Settings for Audio Reference Outputs

DARS Resolution

Select the resolution of the AES3 signal, as 20 bits or 24 bits per sample.

Frame Sync

Select the frame reset signal to synchronize the Word Clock and DARS outputs:

Frame Reset 1 (2.997 Hz)

Frame Reset 2 (6.25 Hz)

Frame Reset 3 (3 Hz)

If a frame reset signal is not used to synchronize the Word Clock and DARS outputs, select **Free Run**.

For information on frame reset signals, see [Epoch-Based Synchronization](#).

Delay

Set the timing offset (in microseconds) of the Word Clock and DARS outputs relative to the internal reference. The delay value has a range of $\pm 160000 \mu\text{s}$ (0.16 s).

Note: The delay value has no effect when the Frame Sync parameter is set to Free Run.

Word Clock Level

Set the signal level voltage for the Word Clock output to either $\pm 1 \text{ V}$, when AC-coupled, or to 0–5 V, when DC-coupled.

Test Signal Generation

In addition to its main function as a synchronization source for a video facility, the SPG9000 can also generate test signals in a variety of different formats on multiple outputs. The SPG9000 includes four independent Serial Digital Interface (SDI) outputs and two network interfaces for IP (ST 2110) stream generation.

Note: The SPG9000-SDI license must be enabled for test signal generation using the SDI outputs.

The SPG9000-IP license must be enabled for test signal generation using the IP interfaces.

The SPG9000 uses a set of video sources and audio sources to define the test signal content, and a set of output interfaces for the test signal transport. In general, a specific source may be sent to multiple outputs. For example, you can configure a video source to generate a color bars video test pattern for a specific format, and re-use that video source for both SDI and IP outputs.

To completely configure the test signal generators, first configure the video and audio sources, then configure the SDI outputs and IP streams.

Video Sources

The SPG9000 has up to six video sources that can be independently configured. Each video source is described by its format (including image size, frame rate, and more), its test pattern (such as color bars), and its timing relative to the system clock.

Video sources are numbered from 1 to 6. Video source 1 is always associated with the SDI 1 output, source 2 with SDI 2, source 3 with SDI 3, and source 4 with SDI 4. Video sources 1 to 4 can also be used for IP video streams, so the same test signal will be used for both output types. Video sources 5 and 6 can only be used for IP video streams. If the SPG9000-IP license is enabled, all 6 sources are available. If only the SPG9000-SDI license is enabled, only sources 1-4 are available.

The complete set of formats supported by the SPG9000 is:

Image Size	Scan Type	Frame Rate	Sampling	Color Space	Bit Depth
720×486	Interlaced	29.97	4:2:2	YCbCr	10
720×576	Interlaced	25	4:2:2	YCbCr	10

Image Size	Scan Type	Frame Rate	Sampling	Color Space	Bit Depth		
1280×720	Progressive	60/59.94/50 30/29.97/25/24/23.98	4:2:2	YCbCr	10		
			4:4:4	YCbCr	10		
			4:4:4	RGB	10		
1920×1080	Progressive	60/59.94/50 30/29.97/25/24/23.98	4:2:2	YCbCr	10		
			4:4:4	YCbCr	10		
			4:4:4	RGB	10		
			4:4:4	YCbCr	12		
			4:4:4	RGB	12		
			4:2:2	YCbCr	12		
	Interlaced	30/29.97/25	4:2:2	YCbCr	10		
			4:4:4	YCbCr	10		
			4:4:4	RGB	10		
			4:4:4	YCbCr	12		
			4:4:4	RGB	12		
			4:2:2	YCbCr	12		
			Segmented	30/29.97/25/24/23.98	4:2:2	YCbCr	10
					4:4:4	YCbCr	10
					4:4:4	RGB	10
4:2:2	YCbCr	12					

Image Size	Scan Type	Frame Rate	Sampling	Color Space	Bit Depth
2048×1080	Progressive	60/59.94/50/48/47.95	4:2:2	YCbCr	10
		30/29.97/25/24/23.98	4:4:4	YCbCr	10
			4:4:4	RGB	10
			4:4:4	YCbCr	12
			4:4:4	RGB	12
			4:2:2	YCbCr	12
			30/29.97/25/24/23.98	4:4:4	XYZ
	Segmented	30/29.97/25/24/23.98	4:2:2	YCbCr	10
			4:4:4	YCbCr	10
			4:4:4	RGB	10
			4:4:4	YCbCr	12
			4:4:4	RGB	12
			4:2:2	YCbCr	12
			4:4:4	XYZ	12
3840×2160	Progressive	60/59.94/50	4:2:2	YCbCr	10
		30/29.97/25/24/23.98	4:2:2	YCbCr	10
			4:4:4	YCbCr	10
			4:4:4	RGB	10
			4:4:4	YCbCr	12
			4:4:4	RGB	12
			4:2:2	YCbCr	12
			4:4:4	RGB	12
4096×2160	Progressive	60/59.94/50/48/47.95	4:2:2	YCbCr	10
		30/29.97/25/24/23.98	4:2:2	YCbCr	10
			4:4:4	YCbCr	10
			4:4:4	RGB	10
			4:4:4	YCbCr	12
			4:4:4	RGB	12
			4:2:2	YCbCr	12
			4:4:4	RGB	12

Note: The IP outputs only support 4:2:2 YCbCr 10-bit progressive and interlaced formats at all frame rates and 4:4:4 RGB and YCbCr 12-bit progressive and interlaced formats up to 30 fps.

Web Interface for Video Sources

On the web interface, select the **Video** tab for the configuration menus for the four or six sources. When the tab is first opened, the Source sections are collapsed:

Status	Reference	Time	PTP	Black	LTC	Video	Audio	SDI	System
▶ Source 1	Source 1	1920x1080 59.94i				100% Color Bars			
▶ Source 2	Source 2	1920x1080 59.94i				100% Color Bars			
▶ Source 3	Source 3	1920x1080 59.94i				100% Color Bars			
▶ Source 4	Source 4	1920x1080 59.94i				100% Color Bars			

The section headers for Source 1 to Source 4 or Source 6 each show a summary of the current configuration, displaying the user-defined label, selected format, and selected video test signal. This makes it easy to view the configuration of all sources at the same time in a table format. Click a Video Source header to open that section and see the submenus for that source.

▼ Source 1 HD Bars 1920x1080 59.94i 100% Color Bars

Label

Current Destination Outputs SDI 1 (1.5G)
IP 1 (1.3 Gbps)

- ▶ Format
- ▶ Test Signal
- ▶ Time Code
- ▶ Overlay
- ▶ Timing

Select the header for Format, Test Signal, Time Code, Overlay, or Timing to open those subsections.

Note: The Time Code and Overlay subsections are only available for video sources 1-4.

Front-Panel Menu for VIDEO

To use the front panel of the SPG9000 for this process, press **VIDEO** repeatedly to select from the source submenus. See [Menu Operations](#) for details of using the front-panel menus.

The table shows the submenus for the VIDEO 1 menu.

VIDEO 1:

LABEL

FORMAT :

IMAGE SIZE

SCAN TYPE

FRAME RATE

SAMPLING

COLORIMETRY

TRANSFER CHAR

RANGE

TEST SIGNAL :

SIGNAL TYPE

TEST PATTERN :

Only available if SIGNAL TYPE is Test Pattern

COLOR BARS

LINEARITY

FLAT FIELD

MULTIBURST

MONITOR

PULSE BAR

TIMING

SDI

IMAGE FILE

Only available if SIGNAL TYPE is Image File

COMPONENT (for Y)

COMPONENT (for Cb)

COMPONENT (for Cr)

EDGE FILTER

AV TIMING MODE

TIME CODE :

SOURCE

OFFSET

DROP FRAME

Only available if the frame rate is 29.97 or 59.94 fps

OVERLAY :

ID TEXT :

(ENABLE)

EDIT	
SIZE	
BORDER	
X POS	
Y POS	
BURNT-IN TIME CODE :	
(ENABLE)	
SIZE	
DATE	
X POS	
Y POS	
LOGO	
(ENABLE)	
FILE	
X POS	
Y POS	
TIMING :	
VERTICAL	
HORIZONTAL	
RELATIVE TO	Only available for 270 Mbps and 1.485 Gbps SDI formats

Configuration Settings for Video Sources

Configure the specific video source:

1. On the web interface, select the **Video** tab.
2. Select the specific Source section (1-4 or 1-6) to configure.

To use the front panel for this process, see [Front-Panel Menu for VIDEO](#).

Label

Enter a user-defined label to identify the video source, such as “HDR UHD Color Bars” for example. The source label is used on the SDI output and IP stream configuration menus to make it easier to describe the source content.

Current Destination Outputs

Displays the current set of outputs for this source. If the source is used with an SDI output, the interface speed is also displayed. For 3G-SDI formats, “3G-A” indicates Level A mapping and “3G-B” indicates Level B mapping. If the source is used with an IP video stream, the estimated bit rate (including L2 overhead) is also displayed.

Format

The format of a video source is comprised of several interrelated parameters. Not all combinations are possible, so the user interface only shows available options for the current selection. Start to set the format with the first format parameter (image size) and continue in order.

Select the Source needed (1-4 or 1-8), then select **Format**.

▼ **Format**

Image Size ▼
Scan Type ▼
Frame Rate ▼ fps
Sampling Structure ▼
Colorimetry ▼
Transfer Characteristics ▼
Range ▼

Image Size

Select the size of the active video region as width-by-height (W×H). The SPG9000 supports these image sizes:

Standard Definition	High Definition, 2K	Ultra High Definition, 4K
720×486	1280×720	3840×2160
720×576	1920×1080	4096×2160
	2048×1080	

Note: The SD formats commonly referred as 525-line and 625-line have 486 and 576 lines of active video respectively.

Scan Type

Select the scan type, as progressive, interlaced, or segmented frame. Not all scan types are available for certain image sizes and frame rates.

Frame Rate

Select the number of frames per second for the video signal. Non-integer frame rates are written with a rounded decimal but the precise frame rate is used. For example, "59.94 fps" is displayed for the actual rate of 60/1.001 fps.

Note: For interlaced formats, the field rate is twice the frame rate. For example, “1080i 50” refers to 50 fields per second, which is 25 frames per second.

Sampling Structure

Select the sampling structure, a combination of:

- Color space: YCbCr, RGB, or XYZ;
- Color sub-sampling: 4:2:2 or 4:4:4; and
- Bit depth: 10-bit or 12-bit.

Not all sampling structures are available for certain image sizes, frame rates, and scan types.

Colorimetry

Select the colorimetry:

Auto

Rec. 709

Rec. 2020

The Auto option is usually the best selection for most applications. The colorimetry choice that is automatically used depends on the selected image size and transfer characteristics:

Image Size	SDR	HDR
Standard Definition	Rec. 601	not available
720-line High Definition	Rec. 709	not available
1080-line HD/2K	Rec. 709	Rec. 2020
2160-line UHD/4K	Rec. 2020	Rec. 2020

The Rec. 709 and Rec. 2020 options can be used to force a specific colorimetry for the current format.

Transfer Characteristics

Select the transfer characteristics:

SDR: Standard Dynamic Range

HDR HLG: High Dynamic Range, Hybrid Log-Gamma

HDR PQ: High Dynamic Range, Perceptual Quantization

Unspecified

Standard definition (720×486 and 720×576) and 720-line high-definition formats only use SDR. The 2K XYZ formats use unspecified transfer characteristics.

Range

Select either **Narrow** range or **Full** range quantization of the 10-bit or 12-bit sample values.

Narrow range is the default and widely used. For 10-bit formats, the video data range is from 4 through 1019 (with 0-3 and 1020-1023 reserved for SDI outputs), but the black (0%) level is 64 and the peak (100%) level is 940. This leaves “headroom,” which is space below 0% and above 100%.

Full range utilizes the entire set of 10-bit or 12-bit values, and is typically used with some HDR formats.

Test Signal

Use the test signal settings to select the needed video pattern and set parameters that affect its appearance.

Select the Source needed (1-4 or 1-6), then select **Test Signal**.

▼ Test Signal

Signal Type Test Pattern ▼

Test Pattern

Category Color Bars ▼

Pattern 100% Color Bars ▼

Description 100/0/100/0 color bars

Video Components Y Enable Cb Enable Cr Enable

Edge Filter Enable

AV Timing Mode Enable

Signal Type

Select the type of test signal for the video source.

Test Pattern: Select one of the predefined test patterns, such as color bars.

Image File: Select a TIFF image file that has been uploaded to the instrument.

Note: The Image File option is not available for video sources 5 and 6.

Test Pattern Parameters

The SPG9000 includes a large set of predefined test patterns, grouped into eight categories.

To select a specific test pattern:

1. Select the **Category** menu and highlight an option.

2. Select the **Pattern** menu and highlight an option. A short description of the selected test pattern appears below the menus.

The next sections describe the different test pattern categories, and the test patterns available in each category.

Color Bars

Color bar test patterns are widely used to verify the integrity of video signal paths and the correct calibration of display monitors. Each bar is a rectangular region of the image with a specific color value, usually expressed as a percentage, such as 75% or 100%. For example, 0% refers to the minimum value for each of the green, blue, and red (GBR) color components and 100% is the maximum value, regardless of whether the format is SDR or HDR. Most video formats use narrow-range quantization, so the 10-bit value corresponding to 0% is 64 (040h) and the value for 100% is 940 (3ACh). Full-range quantization uses the entire 10-bit range from 0-1023 for 0%-100%, although the values 0-3 and 1020-1023 are not used for SDI outputs because they are reserved values for SDI synchronization.

Color bars can also differ depending on the colorimetry used with the YCbCr color space. Standard definition uses Rec.601 coefficients to convert from GBR values to YCbCr, HD (750- and 1080-line formats) uses Rec.709 coefficients, and UHD (2160-line formats) uses Rec.2020 coefficients. Rec. 2020 is also used for 1080-line HD/2K formats when using HDR transfer characteristics. The SPG9000 generates the correct color values depending on the image size and transfer characteristics of the selected format.

Pattern	Description
100% Color Bars 75% Color Bars (100% White) 75% Color Bars (75% White)	Eight full-height bars of white, yellow, cyan, green, magenta, red, blue, and black. This pattern is available with three variations, at 100% value for all bars, at 75% value for colors and 100% for white, and at 75% value for all bars.
100% Color Bars Over Red 75% Color Bars Over Red	These variations on color bars are only available in the 720x576 image size. They consist of the 75% or 100% color bars signal on the top half of the raster, and a matching 75% or 100% red field on the lower half.
SMPTE EG 1 Color Bars	Color bars according to EG 1-1990. This pattern includes 75% color bars, reverse blue bars, -I and +Q sections, black, white, and pluge sections. This pattern is only available for YCbCr formats, since the -I and +Q sections contain color components outside the legal RGB gamut. For standard definition formats, this pattern is only available for the 720x486 image size.

Pattern	Description
SMPTE RP 219-1 HD Color Bars SMPTE RP 219-1 SD Color Bars SMPTE RP 219-2 UHD Color Bars	<p>Color bars according to RP 219-1:2014 and RP 219-2:2016. The RP 219-1 HD pattern is intended for 16×9 aspect ratio displays, with additional elements as compared to EG1 bars. The SPG9000 implementation includes –I and +Q sections, but unlike the similar sections in EG1 bars, they have additional luminance to stay within RGB gamut. The –2% patch of the pluge section is clipped to 0% black for XYZ formats. For SD, the color bars are the 4:3 aspect ratio version, as if converted from the 16:9 image with a center cut. The “sub-black valley” and “super-white peak” ramps are also included.</p> <p>The RP 219-2 pattern is available for UHD formats and 2K/4K formats that are wider than the 16:9 RP 219-1 pattern. The –I and +Q sections are not included.</p>
SMPTE RP 219 with Moving Box	Color bars based on RP 219-1, but with a black region cut out from the main color bars within which a smaller 100% white square moves vertically and horizontally, “bouncing” off the edges of the black region.
SMPTE EG 432-1 Color Accuracy	Split-screen color bars using values from RP 431-2-2007. The upper half of the pattern is essentially the same as 100% color bars, corresponding to the “–1” set of colors defined in Table A.4 of the RP. The lower half is a set of desaturated color bars, corresponding to the “–2” color patch values.
ARIB B28 HD Color Bars ARIB B66 UHD Color Bars	Color bars according to ARIB STD-B28 and STD-B66 for 1920×1080 HD and 3840×2160 UHD formats respectively. The B28 HD pattern is very similar to the SMPTE RP 219-1 bars, without the sub-black and super-white ramps added in the 2014 revision of RP 219. The B66 UHD pattern replaces the 75% white bar with a set of Rec. 709 color bars at 75%. The B66 standard also describes two optional 4K and 8K test sections with a “cyclone” pixel pattern, but these are not included in the SPG9000 version.
BT.2111 HLG Narrow Color Bars BT.2111 PQ Narrow Color Bars BT.2111 PQ Full Color Bars Sony S-Log3 Color Bars	Color bars according to ITU-R BT.2111. These patterns are intended for HDR systems. For best results, select the appropriate transfer characteristics value for the video format. The patterns include 100% color bars at the top, 75%/58%/68.5% color bars, a monochrome step scale from 0% to 109% luminance, a full-scale ramp, BT.709 color bars on the lower left and right, and near-black patches.

Pattern	Description
EBU 3373 HDR Color Bars	Color bars according to EBU Tech 3373, for use in the production of HDR HLG television. The pattern consists of 100% color bars, 75% bars, display-light BT.709 bars, scene-light BT.709 bars, full-range luma ramp, and red, green and blue saturation test patches. The two-sample interleave (2SI) test section from Tech 3373 is not included.
NBCU HDR-SDR Color Bars	“Fancy” color bars are defined by NBCUniversal for their single-master broadcast production and distribution workflow. This pattern is based on the BT.2111 color bars HLG pattern, but it also includes HDR highlight pillars and a LUT pyramid (ramps) on the top left, a clip text indicator (block letter “H”) in the 109% patch of the monochrome step scale section, and both display-light and scene-light BT.709 color bars on the bottom left and right.
EBU 3305 Color Bars with Motion	Color bars based on EBU Tech 3305. This document specifies the pattern definition for SD formats only, but the SPG9000 pattern has been extended to include HD/2K and UHD/4K image sizes. The pattern includes motion sequence 1 (“transmission alive check”), which consists of a thin black bar (with a white center line) that moves vertically within the large red field at the base of the pattern.

Linearity

Linearity test patterns are used to ensure that all expected signal values are processed by the digital system. Ramp patterns are widely used because they include every sample value in the tested range. Visually, a luma ramp (which has only the Y channel for a YCbCr signal or all three channels for an RGB signal) appears as a gradual transition from black to white. On a waveform monitor display set to SDR, the ramp appears as a straight diagonal line. If banding is seen on the displayed image, this could indicate a drop in resolution, such as when a 10-bit signal is viewed on an 8-bit display.

Pattern	Description
5-Step Staircase 10-Step Staircase	Series of vertical bars of equal steps on all three channels. These patterns are color-independent so they will appear differently in YCbCr, RGB, or XYZ color spaces. Since the range of valid levels is not evenly divisible by 5 or 10 steps, the first and last bars slightly exceed the valid range, but are still well within legal limits. For example, the valid range for 10-bit YCbCr formats is from 64–940 for the Y channel (876 steps) and from 64–960 for the Cb/Cr channels (896 steps). Therefore, the level of the first bar is 62 and the level of the last bar is 942/962, which results in equal step sizes across the pattern.

Pattern	Description
Valid Ramp Y Valid Ramp B-Y Valid Ramp R-Y Valid Ramp	The Valid Ramp is a matrix of three different ramps, designed to test the video component channels for YCbCr, and for gamut range testing in all color spaces. These three ramps are also available as individual patterns that span the picture width. First, the Y Valid Ramp spans from black to white, across the valid range of the luminance (Y) channel. Next, the B–Y Valid Ramp spans from yellow to cyan, across the valid range of the Cb color difference channel. Last, the R–Y Valid Ramp spans from cyan to red, across the valid range of the Cr color difference channel.
3 Channel Ramp	Wide ramp from the lower valid value to the upper valid value for all three channels. This pattern is color-independent, so it will appear differently in YCbCr, RGB, or XYZ color spaces. On each side of the ramp there are small plateaus at the blanking level (black) and at the valid level.
Limit Ramp	Wide ramp that spans the legal limit range (4–1019 for 10-bit formats and 16–4079 for 12-bit formats) for all three channels. On each side of the ramp there are small plateaus at the blanking level, the valid level, and the limit level.
Shallow Ramp Matrix	Vertical matrix of shallow ramps that together span the range between legal limits (4–1019 for 10-bit formats and 16–4079 for 12-bit formats). Each bit value is held for 16 pixels for 10-bit formats and for 4 pixels for 12-bit formats. There is overlap between the end of one ramp and the start of the next ramp.
Color Ramp Matrix	Vertical matrix of ramps across the colors available in the valid RGB gamut. Each set of ramps transitions between adjacent hues: red–yellow–green–cyan–magenta–blue–red. From the top of the pattern, the first three rows of ramps are at 25%, 50%, and 75% saturation. The fourth row of ramps includes fully saturated colors at 100% value. The next three rows of ramps are at 75%, 50%, and 25% value. The bottom row of ramps is monochrome.

Flat Field

Flat field patterns are full-frame images of a single color. They are used to verify uniform luminance and chromaticity levels for the entire span of the displayed image. For YCbCr formats, the SPG9000 uses Rec.601 colorimetry for SD image sizes, Rec.709 colorimetry for 720-line and 1080-line HD image sizes, and Rec.2020 colorimetry for 2160-line UHD image sizes.

Pattern	Description
0% Flat Field (Black) 50% Flat Field 100% Flat Field (White)	Full-frame monochrome flat fields.

Pattern	Description
100% Red Field	Full-frame color flat fields.
100% Green Field	
100% Blue Field	
100% Cyan Field	
100% Magenta Field	
100% Yellow Field	
Interlaced Field Test	Full fields, of 100% red for field 1 and 100% blue for field 2, are available only for interlaced formats. When viewed, the combined image should appear purple. If the image is red or blue, only one field from the interlaced signal is present.

Multiburst

Multiburst patterns consist of five or six sine wave packets, each of fixed frequency. This pattern is typically used for frequency response testing for one or three video channels, or for testing monitor resolution. The packets have a 60% amplitude range upon a 50% level, so a range between 20% and 80% levels.

For comparison to these peak limits, flat pedestals at 80% and 20% levels are present on the left side of the pattern. The set of packet frequencies used in each pattern is determined by the maximum bandwidth of the output format.

For 4:2:2 YCbCr formats, one multiburst pattern consists only of a Y channel signal, up to the maximum frequency limit, and the second multiburst pattern is identical for all three channels, up to half of the Y channel frequency limit.

For 4:4:4 formats, each multiburst pattern is identical for all three channels.

Pattern	Description
Multiburst 0.5–2.75 MHz	(SD formats only) Three channel pattern with packet frequencies of 0.5, 1.0, 1.5, 2.0, and 2.75 MHz.
Y Multiburst 0.5–5.75 MHz	(SD formats only) Y channel pattern with packet frequencies of 0.5, 1.0, 2.0, 3.0, 4.0 and 5.75 MHz.
Multiburst 1–15 MHz	(1.5G and 3G formats only) Three channel pattern with packet frequencies of 1, 3, 6, 9, 12, and 15 MHz.
Y Multiburst 15–30 MHz	(1.5G formats only) Y channel pattern with packet frequencies of 15, 18, 21, 24, 27, and 30 MHz.
Multiburst 15–30 MHz	(4:4:4 and fast-progressive 3G formats only) Three channel pattern with packet frequencies of 15, 18, 21, 24, 27, and 30 MHz.

Pattern	Description
Y Multiburst 35–60 MHz	(Fast-progressive 3G formats only) Y channel pattern with packet frequencies of 35, 40, 45, 50, 55, and 60 MHz.

Monitor

The monitor category of test patterns contains images that are used to verify correct color representation, luminance levels, and image geometry for display systems. Color reference charts extend beyond color bars by including more patches than fully-saturated primary colors. Pluge (Picture Line Up Generating Equipment) patterns are used to calibrate brightness at near-black levels. Aperture and convergence patterns are used to verify that the complete image is displayed and centered, and the RGB channels are correctly aligned.

ChromaDuMonde	Color reference chart, used with permission of DSC Laboratories. The pattern consists of a series of DSC standard color patches representing the six primary colors, 18 evenly spaced intermediate colors, and four skin tone reference patches. The 24 primary and intermediate colors will show as a hexagonal shape on a vectorscope display, providing a reference for comparison with a camera-generated image of a physical DSC ChromaDuMonde chart. The pattern also includes an 11-step crossed grayscale section and a center section with 0% black and 100% white patches.
SMPTE 303M Color Reference	Color reference chart according to SMPTE 303M, also known as the GretagMacbeth ColorChecker® chart. Cyan patch #18 cannot be reproduced properly in the RGB and XYZ color spaces because the red component lies at approximately -14%, which exceeds legal limits for RGB formats. This patch will appear as a cyan and black checkerboard pattern, where the cyan patches are of a different hue than the full cyan patch as seen in YCbCr formats because the red component is clipped at 0%. The color values used from SMPTE 303M are those with respect to the D ₆₅ illuminant.
Black-White Step Scale Black-Dark Gray Step Scale	Gray scale patterns according to §6.9 of SMPTE EG 432-1-2007. A series of ten different monochrome patches at increasing luminance values is centered on a gray background, to verify gray scale tracking. The ten steps of the black to white scale are normalized gamma-corrected values of 10% to 100% and the ten steps of the black to dark gray scale are 1/31 to 10/31.
Pluge and Luma Reference	Includes two elements to help in black and white balance. The left side of the pattern contains a pluge pattern, with three vertical bars of -2%, 0%, and +2% black. The right side of the pattern contains four gray boxes corresponding to luminance levels of 110 mV, 200 mV, 450 mV, and 700 mV (100% white) in the analog domain. The -2% patch of the pluge section is clipped to 0% black for XYZ formats.

Checkerboard	4×4 grid of alternating black and white patches, used to measure intra-frame contrast according to §6.8 of EG 432-1-2007.
Window	White square centered on a black background. This pattern can be used as an alternative to a full-field white pattern when it is useful for the average picture level (APL) to approximate normal program content.
Screensaver	Small 75% color bars (about 22% of screen width and 20% of screen height) in motion both vertically and horizontally on a black field, “bouncing” off the edges of the image.
Production Aperture	Includes single-pixel wide lines at the extreme edges of the active video area, marking the complete production aperture. Vertical lines are implemented as single-sample pulses with no edge filtering, so this pattern is not legal as a broadcast signal.
Clean Aperture	Grid pattern according to SMPTE RP 187-1995. The clean aperture is marked by the outer markers, with overscan markers at approximate 2.5% increments. The center 4:3 section of a 16:9 image has an additional set of aperture and overscan markers. Each line on the grid is implemented with two horizontal lines or a double-width pulse centered on two samples, because the actual aperture boundary and the center of the image each lie midway between lines and samples. This pattern is only available for 1080-line, 720-line, and standard definition formats.
Convergence Convergence 4:3	Grid pattern of equal size squares with a dot at the center of each square. Each line and dot is implemented as a single horizontal line or single-sample pulse. This pattern is used to verify convergence of RGB channels, and no color fringing should be visible on the white lines and dots when the channels are aligned.
EBU 3374 EOTF Validation	EOTF (Electro-Optical Transfer Function) chart for HDR calibration and monitoring. The center third of the pattern (vertically) consists of a monochrome step scale with full-range values in 10% steps from 0% to 50%, then 5% steps from 55% to 100%. The left side of the scale has a higher resolution section with steps of 0%, 3%, 6%, and 10% and the right side has a similar section with steps of 90%, 91%, 92%, and 95%.

BT.814 SD Pluge	Pluge patterns for SD and HD/UHD systems as defined in ITU-R BT.814-4.
BT.814 SDR Pluge	
BT.814 HDR Pluge	

The SD pattern is described in Annex 1. It includes three vertical rectangles on the left, at -1.8% , 0% and $+1.8\%$ black, respectively, and four rectangle on the right at luma levels of 100% (white), 63%, 35.2% and 15.1% respectively.

The SDR and HDR patterns for HD and UHD formats are defined in Annex 2. The left side of the image has a series of near-black stripes at approximately $\pm 1.8\%$. The center section has a single rectangle window at 100% white for the narrow-range SDR pattern and 38.2% for the HDR pattern. This level is the same luminance for both PQ and HDR HLG, at approximately 27 nits. The right side of the image has two near-black rectangle windows, at $+1.8\%$ and -1.8% .

Pulse Bar

The pulse and bar test signal is used to test bandwidth and group delay. The pulse has high-frequency content, so if the bandwidth of the signal path is good, the pulse waveform rises to the top of the bar. To view the phase response, examine the ringing on the base of the pulse waveform. If the ringing is low and symmetric, the group delay is good.

Pattern	Description
2T Pulse and Bar	<p>Two pulses of 2T half-amplitude width and full-scale amplitude. A positive pulse is added to a base level at the minimum valid value, and a negative pulse is added to a bar level at the maximum valid value. The 2T pulse is used for Short Time response testing and the bar is used for Line Time response testing.</p> <p>The type of 2T pulse depends on the signal format:</p> <ul style="list-style-type: none"> For SD-525 format, this is a 2T4 pulse. For SD-625 format, this is a 2T5 pulse. For HD and slow-progressive 3G formats, this is a 2T30 pulse. For 3G fast progressive formats, this is a 2T60 pulse. For UHD slow-progressive formats, this is a 2T60 pulse. For 6G and 12G fast-progressive formats, this is a 2T120 pulse. For 4:2:2 formats, chroma pulses are at half the bandwidth.
Color Pulses	<p>Eight color pulses of 2T half-amplitude width upon black and white backgrounds. The upper half of the pattern has positive pulses on a black background, testing each combination of the three color channels. The lower half of the pattern has a white background, so negative pulses are used to result in the same line colors. For example, the yellow pulse in the upper half is 100% red plus 100% green, resulting in yellow on a black background. At the same horizontal location in the lower half, a pulse of -100% blue added to the white background also results in a yellow line.</p>

Timing

The timing pattern is used to verify timing alignment between the three channels of a component video system.

Pattern	Description
Co-siting Pulse	One single-sample wide pulse in the center of the image, used to show the timing relationship and alignment between chroma and luma channels. Different amplitudes are used to distinguish the three channels.

SDI Pathological

A pathological test pattern is a flat field (or a matrix of several flat fields) with a specific set of 10-bit values that is designed to cause stress in an SDI system. These signals can be used to characterize system limits for cable lengths, for example:

An SDI signal is bit stream encoded using the NRZI (non-return-to-zero, inverted) format. The bit stream is scrambled so a long sequence of consecutive 1s or 0s is not usually transmitted. This is preferred because the receiver uses frequent signal transitions to synchronize with the signal. However, a specific sequence of bits at the scrambler input can result in a stressful sequence on the output. Because the scrambler equation is a 9th degree polynomial, the state of the scrambler will statistically be in the necessary initial state for the test signal on 1 out of every 512 lines. The stressful pattern then persists for the full active-video line.

The receiver equalizer can be stressed with a pattern with maximum DC content—or a long sequence of consecutive 1s or 0s—followed by a single bit at the other level. The phase-locked loop of the receiver can be stressed with a pattern that has a low frequency of level transitions, such as 20 consecutive 1s (or 0s) followed by 20 consecutive 0s (or 1s). The bandwidth of the signal path can be stressed with a pattern of as many transitions as possible, such as alternating 1s and 0s in the bit stream.

The equalizer test pattern creates an output signal with a DC bias because of the unequal distribution of bits at the high and low levels. Therefore, an additional component is added to the test pattern to ensure that both polarities of DC bias are generated. RP 198 defines a polarity control word, in which one bit of the first sample in the first active video line is alternated on successive frames. This method has been proven to be ineffective in some cases, so the SPG9000 uses a 10-bit counter for the polarity control word.

The SPG9000 includes “half-length” variations of these test patterns, so named because the output sequence is half the duration of the original patterns defined in SMPTE RP 198-1988. For example, the half-length equalizer test has a sequence repeat pattern of 9 + 1 bits instead of 19 + 1 bits, and the half-length, phase-locked loop test has a sequence repeat pattern of 10 + 10 bits instead of 20 + 20 bits.

The SDI pathological patterns in the SPG9000 are independent of color space and sampling structure, so the displayed color of each field is format-dependent. The RP 198 equalizer test field and PLL test field appear as a shade of magenta and a 24% gray field respectively, only for YCbCr 4:2:2 10-bit HD and SD formats.

Pattern	Description
SDI Checkfield	Checkfield pattern as defined in RP 198, the top half of the field is the equalizer test, which alternates 10-bit words of 300h and 198h. The scrambler output pattern uses 19 consecutive 1s or 0s followed by one bit at the other level. The bottom half of the field is the phase-locked loop test, which alternates 10-bit words of 200h and 110h. The scrambler output pattern uses 20 consecutive 1s or 0s followed by 20 consecutive bits at the other level. This pattern is not available for 2160-line UHD/4K formats because the two-sample interleave (2SI) encoding of those formats.
SDI Checkfield, Half-Length	Checkfield pattern similar to RP 198, but it can be used for all formats, including 6G-SDI and 12G-SDI. The equalizer test repeats a 10-bit word of 14Ch, resulting in an output sequence of 9 consecutive 1s or 0s followed by one bit at the other level. The PLL test repeats a 10-bit word of 218h to produce an output sequence of 10 consecutive bits at each level.
SDI Matrix, Half-Length	Matrix pattern made of the half-length signals, is suitable for all formats. The top third of the image is the equalizer test pattern, the middle third is the PLL test pattern, and the bottom third is the bandwidth test pattern. This pattern is not available for 2160-line UHD/4K formats with 12-bit sampling.
SDI Matrix and Rec.709 Bars	Matrix pattern made of the three half-length signals plus 100% narrow-range color bars, is available for HD/2K formats with YCbCr 4:2:2 10-bit sampling structure.
SDI Matrix and Rec.2020 Bars	Matrix pattern made of the three half-length signals plus 100% narrow-range color bars, is available for UHD/4K formats with YCbCr 4:2:2 10-bit sampling structure.
Equalizer Test, Full-Length	Full-field pattern of the equalizer test signal from RP 198, alternates 10-bit words of 300h and 198h. The scrambler output pattern uses 19 consecutive 1s or 0s followed by one bit at the other level.
Equalizer Test, Half-Length	Full-field pattern of the half-length equalizer test signal, repeats a 10-bit word of 14Ch. The scrambler output pattern uses 9 consecutive 1s or 0s followed by one bit at the other level.
PLL Test, Full-Length	Full-field pattern of the phase-locked loop test signal from RP 198, alternates 10-bit words of 200h and 110h. The scrambler output pattern uses 20 consecutive 1s or 0s followed by 20 consecutive bits at the other level.
PLL Test, Half-Length	Full-field pattern of the half-length, phase-locked loop test signal, repeats a 10-bit word of 218h. The scrambler output pattern uses 10 consecutive 1s or 0s followed by 10 consecutive bits at the other level.

Pattern	Description
Bandwidth Test	Full-field pattern of the half-length bandwidth test signal, repeats a 10-bit word of 277h. The scrambler output pattern uses 9 bits that alternate between levels with the 10 th bit repeated from the 9 th bit.

Image File Parameters

You can use your own image files as video test signals. These can be custom test patterns or photographic images, depending on your test signal requirements. You will need to upload the file to the SPG9000 before it can be selected.

The SPG9000 supports the Tag Image File Format (TIFF) for image files. There are several encoding options for TIFF files; the SPG9000 supports the RGB color space at 8-bit or 16-bit resolution per channel.

If the output format is configured for YCbCr sampling, the SPG9000 will convert the source RGB pixel values to the output sample values according to the **Colorimetry** setting (Auto, Rec. 709, or Rec. 2020). Similarly, the **Range** setting (Narrow or Full) is used to determine how source RGB pixel values should be processed. It is important to understand how the source image file is encoded so that the desired output signal is generated. For example, if the minimum (black) color level in the source file is 0 and the maximum (white) level is 65535 (16-bit) or 255 (8-bit), the image uses full range. Narrow range files will use 4096 (16-bit) or 16 (8-bit) for the black level and 60160 (16-bit) or 235 (8-bit) for the white level.

If the file image size is smaller than the output image size, the image will be centered and padding space will be black. If the file image size is larger than the output image size, the center of the larger image will be visible but the remainder will be cropped.

Image File

TIFF File Name

Image Size 1920x1080

Color Space RGB

Bits per Sample 16,16,16

Compression LZW

To select a specific image file:

1. If necessary, upload the file to the SPG9000. See [File Management](#).
2. Select the **TIFF File Name** menu and choose a file from the list. The file header is examined and metadata for the file is displayed. If the file format is unsupported, the corresponding metadata value will be highlighted in red text.
3. Select the **Load Image** button to load the TIFF file into the SPG9000 display memory. This will take a few seconds depending on the image size.

Video Components

Select or clear the checkboxes to enable or disable any of the constituent component channels of the test pattern. For example, if a YCbCr format is selected, you could disable the Cb and Cr (chroma) channels to only view the Y (luma) component of the current test pattern.

Edge Filter

Select or clear the checkbox to enable or disable the edge filter. When enabled, a low-pass filter is used for certain data transitions between adjacent levels to set rise times, pulse widths, and to prevent ringing on the output signal.

If the filter is disabled, the edges are not filtered. The filter should not be disabled in broadcast environments.

Note: The edge filter is not available when the Signal Type is set to Image File. It is the responsibility of the image file creator to ensure that pixel transitions within the image and at the left and right edges are appropriate for the test signal application.

AV Timing Mode

Select or clear the checkbox to enable or disable the AV timing mode. When enabled, the active video will switch to black for 4.5 seconds and then switch back to the current test signal for $\frac{1}{5}$ seconds in a repeating cycle. The embedded audio for an SDI output or the associated audio stream for an IP output will simultaneously be muted on all channels for the same duration that the video is blanked. The resulting “flash/pop” effect can be used to measure the audio-video delay using a Telestream waveform monitor such as the PRISM or WFM/WVR series.

To use AV Timing Mode with a ST 2110-20 video stream and a 2110-30 audio stream, you will need to enable the mode for the video source and also select the video source in the IP audio stream configuration. See [Configuration Settings for IP Streams](#).

Time Code

Video sources have an associated time code counter that are used when the burnt-in time code overlay is enabled, and when ancillary time code is enabled for SDI outputs. The same time code digits are used simultaneously for both purposes, so they are configured together with the video source.

Note: The time code configuration is only available for video sources 1-4, but not sources 5-6 as they are not used for SDI outputs and they do not support the overlay feature.

On the web interface, select the video Source (1-4), then select **Time Code**.

▼ Time Code

Source Local (DST) ▼

Offset +00:00:00:00

Drop-Frame (30 fps) Enable

Source

Select the time source for the time code counter:

Local (DST): Uses the main time-of-day plus the time zone offset plus the daylight saving time offset to compute the local time.

Local (No DST): Uses the main time-of-day plus the time zone offset, but excludes any daylight saving time offset to compute the local time.

UTC: Uses Coordinated Universal Time instead of a local time.

Program Time: Uses the program time counter instead of a time-of-day value. See [Program Time Counter](#).

The time code data includes the hours, minutes, seconds, and frames digits (HH:MM:SS:FF) according to ST 12-1 and the year, month, day, and time zone information according to ST 309.

Offset

Enter a time offset (hours, minutes, seconds, and frames) relative to the selected source time. For example, you could use the time code for a different time zone than the system normal time zone by specifying an offset of ± 1 or more hours.

Drop-Frame (30 fps)

Select this checkbox to enable drop-frame time code. This option is only available when the format has a frame rate of 29.97 fps or 59.94 fps. This option should be selected for most applications where the time code represents time-of-day; this is so the time code is similar to the real-time clock. See [Daily Jam Sync](#) for keeping 30 fps drop-frame time code aligned with the main time-of-day (MTOD). Non-drop frame (NDF) time code is sometimes used in editing and post-production, typically when also using the Program Time source.

Overlay

The video generator of the SPG9000 can add optional overlays to the active test signal. If the background test signal changes, the overlays remain unchanged.

There are three independent overlays:

ID Text: Static text to identify the signal source, for example.

Burnt-In Time Code: Dynamic text for the current digits of the video source's time code.

Logo: Color image for a network or company logo, for example.

All three overlays with a color bars test pattern are shown. The position of all overlays is adjustable, and the character sizes of the ID text and time code overlays are also independently adjustable.

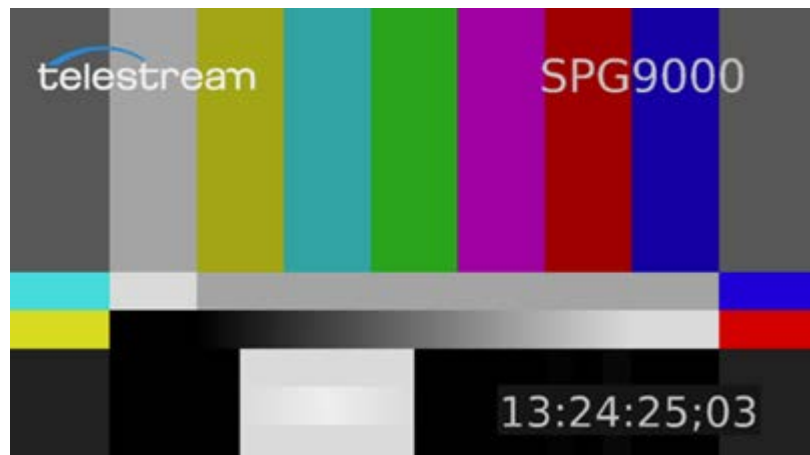

On the web interface, select the video Source (1-4), then select **Overlay**.

Note: The overlay feature is only available for video sources 1-4, but not sources 5-6. Sources 1-4 can be used for both SDI outputs and IP video streams.

ID Text

The ID Text overlay displays a static string of one or more lines of text, which is useful for identification of the channel or the signal source, for example. The text is composed from Unicode characters so that most written languages can be represented. See [Fonts](#).

ID Text

ID Text Overlay Enable

Display Text

Text Size % APH

Border Enable

X Position % APW

Y Position % APH

ID Text Overlay

Select or clear the checkbox to enable or disable the text overlay.

Display Text

Enter the text to be displayed. On the web interface, you can enter multiple lines of text and you can enter any Unicode character, such as text from languages such as Chinese or Japanese. On the front-panel menu, you can only edit the first line of text and you can only use the 95 displayable characters in the Unicode range U+0020 to U+007E (ASCII).

Text Size

Enter the character size for the display text, expressed as a percentage of active picture height (% APH). For example, for a 1080-line HD image size, 10.0% APH would be 108 pixels. If the test signal format is changed to 720-line HD, the text size would change to 72 pixels and therefore the text will scale along with the test pattern. The maximum text size is 25% APH.

Border

Select the checkbox to display the near-white (90%) text inside a near-black (10%) rectangular box background. If the border is disabled, the text is displayed with transparency between the characters. The border is useful if the background test pattern does not have enough contrast with the near-white text.

X Position

Enter the position of the left edge of the text overlay, expressed as a percentage of the active picture width (% APW). The X position is relative to the left edge of the image (0%).

Y Position

Enter the position of the top edge of the text overlay, expressed as a percentage of the active picture height (% APH). The Y position is relative to the top edge of the image (0%).

Burnt-In Time Code

Burnt-in time code (BITC) Displays the digits of the time code counter for the video source. For SDI outputs, the Ancillary Time Code (ATC) digits will exactly match the BITC digits for every frame.

The BITC digits are displayed as HH:MM:SS;FF or HH:MM:SS:FF with two digits for hours, minutes, seconds and frames respectively. The separator between the seconds digits and the frames digits will be a semicolon if the time code uses drop-frame format or a colon for non-drop format. If the frame rate is higher than 30 fps, ".0" or ".1" will be appended to the frames digits to indicate the first or second frame in the frame pair.

Burnt-In Time Code

BITC Overlay Enable

Text Size ▼

Display YYYY-MM-DD Enable

X Position % APW

Y Position % APH

BITC Overlay

Select or clear the text box to enable or disable the time code overlay.

Text Size

Select the size to be used for BITC text: The **Small** size is approximately 11% of the active picture height, and the **Large** size is twice as big as the small size.

Display YYYY-MM-DD

Select the checkbox to include the year, month and day in the BITC overlay. These digits will appear on a second line of text, beneath the HH:MM:SS:FF digits.

X Position

Enter the position of the left edge of the time code overlay, expressed as a percentage of the active picture width (% APW). The X position is relative to the left edge of the image (0%).

Y Position

Enter the position of the top edge of the time code overlay, expressed as a percentage of the active picture height (% APH). The Y position is relative to the top edge of the image (0%).

Logo

The logo overlay displays a full-color picture file (PNG format) such as a network or company logo. The logo image can include a transparency (alpha) channel so that the background is visible around curved edges, for example.

To use a logo image, the file must first be uploaded to the SPG9000. See [File Management](#).

Note: The logo image does not scale when the test signal format is changed. For example, a logo that appears as the desired size when the image size is 1920×1080 HD will look larger than expected if the image size changes to SD and will look smaller than expected if the image size changes to UHD. You may want to create multiple versions of your logo for different sizes of the test signal.

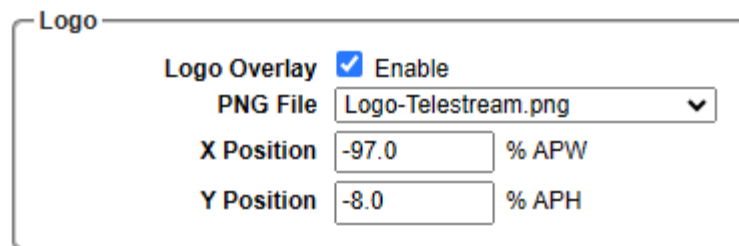

Logo

Logo Overlay Enable

PNG File Logo-Telestream.png

X Position -97.0 % APW

Y Position -8.0 % APH

Logo Overlay

Select or clear the checkbox to enable or disable the logo overlay.

PNG File

Select the logo image file from the list. To add, delete, or rename files in the list, select the **System** tab of the web interface and then select **File Manager**.

X Position

Enter the position of the right edge of the logo overlay, expressed as a percentage of the active picture width (% APW). The X position is relative to the right edge of the image (0%). Therefore, the X Position value will be a negative number, with –100% representing the left side of the image.

Y Position

Enter the position of the bottom edge of the logo overlay, expressed as a percentage of the active picture height (% APH). The Y position is relative to the bottom edge of the image (0%). Therefore, the Y Position value will be a negative number, with –100% representing the top side of the image.

Note: The positions of the ID text and BITC overlays are relative to the top left corner of the image, but the position of the logo overlay is relative to the bottom right. This is intentional because logos are often inserted in the bottom right corner.

Timing

The Timing settings adjust the timing offset of the output signal relative to the internal frame reset. See [Epoch-Based Synchronization](#) to understand how frame resets are synchronized with respect to the reference source.

The total timing offset is a combination of whole lines (vertical delay) and partial lines (horizontal delay). A negative value means the internal clock is advanced relative to the frame reset.

On the web interface, select the Source needed (1-4 or 1-6), then select **Timing**.

The screenshot shows a configuration panel titled "Timing" with a dropdown arrow. It contains three settings: "Vertical" with a text input field containing "0" and the unit "lines"; "Horizontal" with a text input field containing "0" and the unit "μs"; and "Relative To" with a dropdown menu currently set to "Serial (0H)".

Vertical Delay

Enter an integer number of lines, in 1 line increments. The delay range is from $-\frac{1}{2}$ to $+\frac{1}{2}$ frame. For example, the range for a 1080-line HD format is ± 562 lines, because the complete frame size, including vertical ancillary data space, is 1125 lines.

Horizontal Delay

Enter the delay value in microseconds. The timing adjustment range is ± 1 line, where the line length depends on the selected signal format. For example, the duration of one video frame at 25 fps is 40 milliseconds. Each line of the 1125-line HD format has a duration of $35.5556 \mu\text{s}$, so the horizontal delay range is from $-35.5556 \mu\text{s}$ to $+35.5556 \mu\text{s}$.

Relative To

Select the zero-timing compensation factor for the delay adjustment. The default (0H) is correct for most applications. Select Analog (DAC) to apply a compensation factor for a nominal digital-to-analog converter in the timing measurement circuitry, which was present in some older waveform monitors.

Note: This menu is only available for 1.485 Gbps (HD) and 270 Mbps (SD) output formats.

Audio Sources

The SPG9000 has 32 audio tone sources that can be independently configured. Each audio tone source is described by its amplitude, frequency, and identification. Changing the configuration settings for an audio source affect all outputs that use that specific source.

Web Interface for Audio Sources

On the web interface, select the **Audio** tab and then select **Tones**.

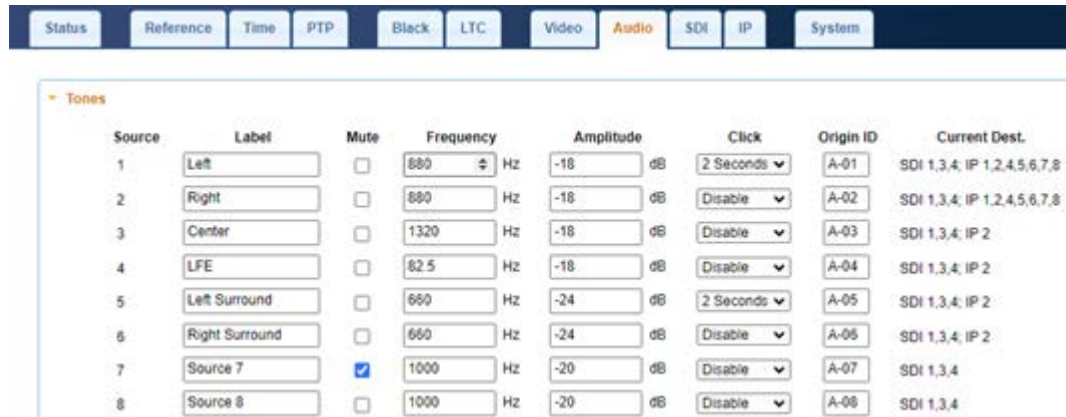

Front-Panel Menu for AUDIO

To use the front panel of the SPG9000 for this process, select **AUDIO** and then select **TONES**. See [Menu Operations](#) for details of using the front-panel menus.

The table shows the submenus for the SOURCE 1 menu.

AUDIO:

TONES :

SOURCE 1 :

LABEL

MUTE

FREQUENCY

AMPLITUDE

CLICK

ORIGIN ID

REFERENCE :

Configuration Settings for Audio Sources

Configure and label the specific video source. There are several options to select in this menu.

To use the front panel for this process, see [Front-Panel Menu for AUDIO](#).

Label

Enter a user-defined label to identify the audio source, such as "Program Left." The source label is used on the SDI and IP output configuration menus to make it easier to describe the source content.

Mute

Select this checkbox to mute the audio channel. Audio sample values are set to zeros instead of the tone data sample values.

Frequency

Enter the tone frequency for the audio source, from a minimum of 10 Hz to a maximum of 20000 Hz, in 0.5 Hz steps.

Amplitude

Enter the amplitude for the audio source, from a minimum of -60 dB to a maximum of 0 dB, in 1 dB steps.

Click

Select the total period of the tone and 250 ms of mute. The transition to mute sounds like a click in the continuous tone. Select from 1, 2, 3, or 4 seconds of tone and mute between clicks. For example, a time of 3 seconds has 2.75 seconds of audio followed by a click and 0.25 seconds of mute. This can be useful to identify one channel of a stereo pair. Disable the click for an uninterrupted tone.

Origin ID

Set the channel origin value used in AES3 channel status metadata. This is an alphanumeric field of four characters, which can be used to identify the specific audio channel by equipment that decodes this value from received audio streams.

SDI Outputs

The SPG9000 has four serial digital interface (SDI) outputs, labeled SDI 1 to SDI 4 on the back panel of the instrument. Each output is used with an independent video source, so any supported combination of video formats and test signal content can be used on the four outputs simultaneously.

Each SDI output is directly connected with a specific video source. The SDI 1 output uses video source 1, SDI 2 uses video source 2, and so on. See [Video Sources](#) to configure the format, test signal, and timing information.

Each SDI output has an independently configurable, embedded audio configuration. The outputs use sources from the Audio tab, in Tones, for the 16 available channels. See [Audio Sources](#) to configure the amplitude and frequency of each audio tone source.

SDI outputs can also generate ancillary time code (ATC) with a selectable time source and offset. Both LTC and VITC variants of ATC can be included simultaneously in the ancillary data space.

Web Interface for SDI Outputs

On the web interface, select the **SDI** tab, then select from the SDI 1-4 to open the configuration menus for the outputs. When the SDI tab is first opened, the four sections labeled SDI 1 to SDI 4 are collapsed:

Status	Reference	Time	PTP	Black	LTC	Video	Audio	SDI	IP	System
▶ SDI 1	HD 1.5G					HD SDR Bars		1920x1080 29.97p		SMPTE EG1 Color Bars
▶ SDI 2	HD 3G-A					3G HDR Bars		1920x1080 59.94p		SMPTE RP 219-1 HD Color Bars
▶ SDI 3	UHD 12G					UHD SDR Bars		3840x2160 59.94p		SMPTE RP 219-2 UHD Color Bars
▶ SDI 4	UHD 12G					UHD HDR Bars		3840x2160 59.94p		BT.2111 HLG Narrow Color Bars

The section headers for SDI 1 to SDI 4 each show a summary of the current configuration. Each displays the interface speed for the current format, user-defined label, selected format, and selected video test signal. Select an SDI output header to open that section and see the output submenus: Video, Embedded Audio, and Ancillary Time Code.

▶ SDI 1	HD 1.5G	Source 1	1920x1080 59.94i	100% Color Bars
▶ Video				
▶ Embedded Audio				
▶ Ancillary Time Code				

Front-Panel Menu for SDI

To use the front panel of the SPG9000 for this process, press **SDI** repeatedly to select from the four output submenus. See [Menu Operations](#) for details of using the front-panel menus.

The table shows the submenus for the SDI 1 menu.

SDI 1 :

VIDEO :

SOURCE

PAYLOAD ID MODE

PAYLOAD ID VALUE

EDH

Only available if PAYLOAD ID MODE is Manual
Only available if the video format is standard definition

3G MODE

Only available if the interface speed is 3 Gbps

EMBEDDED AUDIO :

GROUP 1 :

SDI 1 :

(ENABLE)

CHANNEL 1 (active)

CHANNEL 1 (source)

CHANNEL 2 (active)

CHANNEL 2 (source)

CHANNEL 3 (active)

CHANNEL 3 (source)

CHANNEL 4 (active)

CHANNEL 4 (source)

SAMPLING

GROUP 2 : Same submenus as GROUP 1

GROUP 3 : Same submenus as GROUP 1

GROUP 4 : Same submenus as GROUP 1

ANCILLARY TIME CODE :

ATC_LTC

ATC_VITC

Configuration Settings for SDI Outputs

Configure the specific SDI output:

On the web interface, select the **SDI** tab, and then select the specific output section (SDI 1 to SDI 4) to configure.

To use the front panel for this process, see [Front-Panel Menu for SDI](#).

Video

The Video section is used to configure the SDI-specific options for the video output signal. See [Configuration Settings for Video Sources](#) to change the format, test signal, or timing.

▼ Video

Source 1 (Source 1)

SMPTE 352 Payload ID

3G-SDI Mode

Source

Displays the video source number and its user-defined label used for the output.

SMPTE 352 Payload ID

Select the mode for the insertion of the video payload identifier (VPID) in the ancillary data space of the SDI signal. The VPID is defined in ST 352 and subsequent specifications, and is used by SDI equipment to correctly interpret or display the received signal. VPID carries information such as the sampling structure, colorimetry, transfer characteristics, bit depth, and range. Without that metadata, a receiver would not be able to automatically know if the signal is YCbCr or RGB, SDR, or HDR, or other essential parameters.

The VPID is a 32-bit (four byte) value that is carried in an ancillary data packet that is inserted once per frame or field, and for each internal data stream. For example, a 12G-SDI signal is composed of 8 data streams so there are 8 copies of the VPID in the ancillary data for each video frame.

Select from the options:

Automatic: The system automatically inserts the correct VPID based on current video format values.

Manual: Enter the VPID value as 8 hexadecimal digits. This option can be used to signal video formats not supported directly by the instrument. For example, to signal the $IC_T C_P$ color difference signal instead of $Y' C'_B C'_R$, use a VPID value with bit 4 of byte 4 set to 1 instead of 0.

Disable: The system will not insert the VPID in the ancillary data space.

Note: Automatic mode is recommended for most applications. Changing or disabling the VPID should be done with care. If the video format is changed when manual mode is used, the VPID value must also be updated.

3G-SDI Mode

Select the mapping for 3G-SDI formats, as defined in SMPTE ST 425-1, from the options:

Level A: Select the direct mapping for the two data streams comprising the 3G-SDI signal.

Level B: Select the dual-link mapping for transporting a ST 372 Dual-Link interface over a single 3G-SDI link.

This menu is only available if the selected video format requires a 3G-SDI output and both levels are supported, as listed in the table. For the 1280×720 image size with 4:4:4 sampling, only Level A is defined.

Image Size	Scan Type	Frame Rate	Sampling	Color Space	Bit Depth
1920×1080	Progressive	60/59.94/50	4:2:2	YCbCr	10
	Any	30/29.97/25/24/23.98	4:4:4	Any	Any
			4:2:2	YCbCr	12

Image Size	Scan Type	Frame Rate	Sampling	Color Space	Bit Depth
2048×1080	Progressive	60/59.94/50/48/47.95	4:2:2	YCbCr	12
		Any	4:4:4	Any	Any
	Any	30/29.97/25/24/23.98	4:2:2	YCbCr	12

Note: If Level B is selected for a 3G-SDI signal, the corresponding video source cannot be used for a ST 2110-20 video IP stream. See [Video Streams](#).

SD-SDI EDH

Check this box to enable the automatic insertion of Error Detection and Handling (EDH) packets in the ancillary data space of the SDI signal according to SMPTE RP 165. This option is only available for standard definition (SD-SDI) formats. It is not needed for 1.5 Gbps and higher SDI formats because they include a CRC checksum on each line of the SDI signal.

Embedded Audio

The Embedded Audio section is used to map audio sources into embedded audio groups in the SDI output signal. See [Configuration Settings for SDI Outputs](#) to change the frequency, amplitude, and other parameters for the individual audio tones.

Audio is carried in the ancillary data space of an SDI signal and is organized into 4 groups of 4 channels each according to SMPTE ST 299-1. Each group can be individually enabled or disabled.

Note: For wide image formats (2048×1080 and 4096×2160) at higher frame rates (60, 59.94, 30, or 29.97 fps), there is not enough horizontal ancillary data space to carry 4 groups of audio. For these formats, only groups 1 and 2 are used.

▼ Embedded Audio

Enable	Channel 1	Channel 2	Channel 3	Channel 4	Sampling
Group 1 <input checked="" type="checkbox"/>	<input checked="" type="checkbox"/> 1 (Left) ▼	<input checked="" type="checkbox"/> 2 (Right) ▼	<input checked="" type="checkbox"/> 3 (Center) ▼	<input checked="" type="checkbox"/> 4 (LFE) ▼	Frame ▼
Group 2 <input checked="" type="checkbox"/>	<input checked="" type="checkbox"/> 5 (Left Surround) ▼	<input checked="" type="checkbox"/> 6 (Right Surround) ▼	<input checked="" type="checkbox"/> 7 (Left 1kHz) ▼	<input checked="" type="checkbox"/> 8 (Right 1kHz) ▼	Frame ▼
Group 3 <input checked="" type="checkbox"/>	<input checked="" type="checkbox"/> 9 (Left 2kHz) ▼	<input checked="" type="checkbox"/> 10 (Right 2kHz) ▼	<input type="checkbox"/> 11 (Source 11) ▼	<input type="checkbox"/> 12 (Source 12) ▼	Frame ▼
Group 4 <input type="checkbox"/>	<input type="checkbox"/> 13 (Source 13) ▼	<input type="checkbox"/> 14 (Source 14) ▼	<input type="checkbox"/> 15 (Source 15) ▼	<input type="checkbox"/> 16 (Source 16) ▼	Frame ▼

Enable

Select this checkbox to enable the respective group. Ancillary data packets with the corresponding DID value are inserted into the SDI signal as shown in the table:

Group	Audio Data DID	Audio Control DID
1	E7	E3
2	E6	E2
3	E5	E1
4	E4	E0

Channel 1 to Channel 4

Select the checkbox to set the active bit in the audio control packet, marking this channel as active. Clear the checkbox to mark the channel as inactive.

Select the audio source for the embedded audio channel. Any of the 32 audio sources can be used for any embedded audio channel, and the same audio source can be used more than one time.

Sampling

Select the audio sampling alignment status that is signaled in the audio control packets (ACP) for the group:

Frame: Selects synchronous sampling with audio frame numbers included in the ACP.

Frame w/o Frame #: Selects synchronous sampling without audio frame numbers in the ACP.

Asynchronous: Selects asynchronous sampling.

Ancillary Time Code

The ancillary time code (ATC) section is used to configure the insertion of ATC packets in the SDI output signal. ATC is described in the SMPTE ST 12-2. The SPG9000 supports the ATC_LTC and ATC_VITC payload types, which identify the carriage of linear time code (LTC) and vertical interval time code (VITC) code words respectively. Both packet types can be inserted simultaneously in the same SDI output signal.

The time code source, offset, and drop-frame format are configured with the video source. This ensures that the same time code digits are used for both ancillary time code packets and burnt-in time code overlay in the video signal. See [Time Code](#).

▼ Ancillary Time Code

ATC_LTC Enable
 ATC_VITC Enable

ATC_LTC

Select this checkbox to enable the insertion of ATC_LTC packets in the SDI output signal, on line 10 in the horizontal ancillary data space. One packet is included per frame for all frame rates. For frame rates higher than 30 fps, the same ATC_LTC packet is repeated for two frames.

ATC_VITC

Check this box to enable the insertion of ATC_VITC1 and ATC_VITC2 packets in the SDI output signal, on line 9 in the horizontal ancillary data space. For interlaced and segmented formats, ATC_VITC1 packets are used for field 1 or segment 1, and ATC_VITC2 packets are used for field 2 or segment 2. For progressive formats with frame rates greater than 30 fps, the field mark bit in the VITC code word is used to identify the first or second frame in a pair that share the same time code digits.

IP Streams

The SPG9000 has two SFP ports, labeled IP 1 and IP 2 on the back panel of the instrument. When SFP28 (25 Gbps) or SFP+ (10 Gbps) modules are installed, the SPG9000 can generate multiple ST 2110 streams simultaneously, each on one or both interfaces. The SPG9000 supports up to 6 ST 2110-20 video streams, up to 6 ST 2110-30 audio streams and up to 6 ST 2110-40 ancillary data streams, each with independent content.

When a stream is configured to use both IP ports, RTP packets are duplicated, creating redundant IP flows compliant with ST 2022-7.

Each video stream may be used with an independent video source, so any supported combination of video formats and test signal content can be used on the six streams simultaneously. See [Video Sources](#) to configure the format, test signal, time code, overlay, and timing information. Video sources 1-4 are used by SDI outputs, so the same video test signal can be generated using SDI and IP at the same time. The port utilization is monitored so that the capacity of the interface (25 Gbps or 10 Gbps) is not exceeded.

Audio streams can each be configured with an independent number of channels, from 1 to 16 per stream. Audio sources are shared between different streams and with embedded audio channels on SDI outputs. See [Audio Sources](#) to configure the amplitude and frequency of each audio tone source.

Data streams are used to carry ancillary time code (ATC) with a selectable time source and offset. Both LTC and VITC variants of ATC are supported.

Web Interface for Network Settings

Most IP configuration parameters are set from the IP tab of the web interface or by pressing the IP button on the front-panel interface, but the network interface settings are configured from the System tab of the web interface or the SYSTEM : NETWORK menu of the front-panel menu.

On the web interface, click the **System** tab and then click **Network Settings**.

The screenshot shows the 'Network Settings' page. It features a table for 'Addresses' and a section for 'DiffServ Code Points (DSCP)'. The 'Addresses' table has columns for Enable, SFP Module, Port Speed, RS-FEC, MAC Address, DHCP, IPv4 Address, Subnet Mask, and Gateway. The 'DiffServ Code Points (DSCP)' section has sub-sections for PTP Event, PTP General, and RTP, with dropdown menus for each.

Addresses	Enable	SFP Module	Port Speed	RS-FEC	MAC Address	DHCP	IPv4 Address	Subnet Mask	Gateway
PTP 1	<input checked="" type="checkbox"/>	10 Gbps / 850 nm	10 Gbps		00-90-56-01-10-01	<input checked="" type="checkbox"/>	Waiting for DHCP	Waiting for DHCP	Waiting for DHCP
PTP 2	<input checked="" type="checkbox"/>	Not installed	Auto		00-90-56-01-0f-ab	<input type="checkbox"/>	172.16.2.50	255.255.255.0	172.16.2.1
IP 1	<input checked="" type="checkbox"/>	25 Gbps / 850 nm	Auto	<input type="checkbox"/>	00-90-56-17-41-60	<input type="checkbox"/>	172.16.3.50	255.255.255.0	172.16.3.1
IP 2	<input checked="" type="checkbox"/>	25 Gbps / 850 nm	Auto	<input type="checkbox"/>	00-90-56-17-41-61	<input type="checkbox"/>	172.16.4.50	255.255.255.0	172.16.4.1

DiffServ Code Points (DSCP)	PTP Event	PTP General	RTP
PTP 1	EF (46)	DF (0)	
PTP 2	EF (46)	DF (0)	
IP 1			AF41 (34)
IP 2			AF41 (34)

Buttons: Apply Changes, Cancel Changes

Front-Panel Menu for Network

To use the front panel of the SPG9000 for this process, press SYSTEM and then select the NETWORK option. See [Menu Operations](#) for details of using the front-panel menus. The table shows the NETWORK menu, and submenus for IP 1 and IP 2.

SYSTEM :

PRESET :

INFO :

NETWORK :

MGMT :

PTP 1 :

PTP 2 :

IP 1 :

PORT

SPEED

DHCP

IP ADDRESS

SUBNET MASK

GATEWAY

MAC ADDRESS

RS-FEC

DSCP (RTP)

IP 2 :

Same menu and submenus as IP 1

FRONT PANEL :

WEB :
GENERAL PURPOSE INTERFACE :
POWER SUPPLY :
FIRMWARE UPGRADE
CALIBRATE OVEN
DIAGNOSTICS

Configuration Settings for IP Network Interfaces

Before configuring IP stream settings, check that the network interfaces for the two ports are configured appropriately for the network. The factory default settings are IPv4 addresses of 172.16.3.50 for IP 1 and 172.16.4.50 for IP 2. These almost certainly need to be changed for the local network.

Enable

Check this box to enable the network interface. When disabled, no streams will be transmitted and the interface will not respond to received messages such as ping messages.

SFP Module

This is a read-only status of the SFP module that is only displayed on the web interface. If no SFP module is detected, "Not Installed" appears in the status. If the interface is enabled, this text is red to highlight the error condition.

If an SFP module is detected, the status indicates the interface speed and the laser wavelength, if applicable. For example, this can help identify mismatches between short-reach (850 nm) and long-reach (1310 nm) transceivers on the SPG9000 side and the switch side of the link.

Port Speed

Selects the data rate of the network port. The **Auto** selection will select the most appropriate speed based on parameters read from the SFP module. In some cases, such as when Direct Attach Cables (DACs) are used, the port speed may not be available from SFP data. Select **10 Gbps** or **25 Gbps** to manually set the desired port speed.

RS-FEC

Check this box to enable Reed-Solomon Forward Error Correction (RS-FEC) for the link. The SPG9000 uses the IEEE 803.3by Clause 108 standard for 25 Gigabit Ethernet. If a 10 Gbps SFP+ module is installed, this option is not available.

Note: Some switches may use a different FEC protocol. In this situation, we recommend disabling RS-FEC on both the SPG9000 and the switch sides of the link.

MAC Address

This is a read-only value of the physical address of the network interface. The first three octets of a MAC address indicate an Organizationally Unique Identifier (OUI), to help identify equipment on the network. The OUI for Telestream is 00-90-56, so the MAC addresses always begin with these three octets.

DHCP

Check this box to enable Dynamic Host Configuration Protocol (DHCP) on the interface. In this case, a DHCP server must be present on the network and it assigns the IPv4 address, subnet mask, and gateway address. If the user enables DHCP, manual configuration of those values is disabled but the values provided by the DHCP server are displayed.

IPv4 Address

Enter the four octets of the IPv4 address, in dotted decimal notation. On the front-panel interface, an edit menu (see [Edit Menus](#)) is used to enter the address, using three digits for each octet with leading zeros if necessary. For example, an address displayed as 192.168.1.50 on the web interface appears as 192.168.001.050 on the front-panel interface. If DHCP is enabled, the IPv4 address supplied by the DHCP server is displayed instead and cannot be edited.

Subnet Mask

Enter the four octets of the subnet mask, in dotted decimal notation. If DHCP is enabled, the subnet mask supplied by the DHCP server is displayed instead and cannot be edited.

Gateway

Enter the four octets of the gateway address for this subnet, in dotted decimal notation. If DHCP is enabled, the gateway address supplied by the DHCP server is displayed instead and cannot be edited.

DiffServ Code Points

Select the DSCP value for transmitted RTP packets.

Differentiated Services (DiffServ) is a mechanism for applying quality of service (QoS) to IP networks. A DiffServ Code Point (DSCP) is a 6-bit value (between 0 and 63) that is included in the header of an IP packet. It identifies the type of traffic and its associated priority.

RTP media streams default to using the Assured Forwarding class (defined in RFC 2597) with the AF41 codepoint (value of 34) as specified in AES67-2018.

Apply Changes

Click to accept any changes made to the network settings since opening the panel on the web interface.

Cancel Changes

Click this button to cancel any changes made to the network settings and restore the previously saved settings.

Web Interface for IP Streams

On the web interface, select the **IP** tab, then select **Video Streams**, **Audio Streams**, or **Data Streams** to select the stream type. When the IP tab is first opened, the sections are collapsed:



The **Port Utilization** section is always visible at the top of the tab, and shows the bit rate estimate for video streams currently enabled for each of the IP 1 and IP 2 ports. The total capacity (Used plus Free plus Reserved) is determined by the SFP type. When all video streams are disabled, the port utilization will still show 1.3 Gbps is reserved. This bandwidth is reserved for all audio and data streams that may be in use, and for all non-ST 2110 traffic that may be present on the interface.

Video Streams

Select **Video Streams** to configure ST 2110-20 video streams. When the section is first opened, the six individual video stream sections are collapsed.

The section headers for the 6 video streams each show a summary of the current configuration, displaying the selected video source, format, and destination IP address(es). This makes it easy to view the configuration of all video streams together, in a table-like format. Click on a header to open that section to see the menus for that video stream.

Video Streams

Stream 1	Plain Bars	1920x1080 29.97p	227.0.1.1 / 227.0.1.2
Stream 2	UHD HDR HLG	3840x2160 59.94p	227.0.2.1 / 227.0.2.2
Stream 3	HDR Bars	1920x1080 59.94i	227.0.3.1 / 227.0.3.2
Stream 4	Disabled		
Stream 5	Disabled		
Stream 6	Disabled		

When a section is opened, the parameters for the video stream can be configured.

Stream 1 Plain Bars 1920x1080 29.97p 227.0.1.1 / 227.0.1.2

Stream Enable
 Label SPG9000 Video 1
 Video Source 1: Plain Bars (1.3276 Gbps)
 Packing Mode General
 TR_{OFFSET} Default 1275 μs

Transport Parameters

RTP Payload Type 96

	Enable	Source IP Address	Destination IP Address	Source Port	Dest. Port
Port 1	<input checked="" type="checkbox"/>	172.16.3.50	227.0.1.1	50020	50020
Port 2	<input checked="" type="checkbox"/>	172.16.4.50	227.0.1.2	50020	50020

View SDP

Audio Streams

Select **Audio Streams** to configure ST 2110-30 audio streams. When the section is first opened, the six individual audio stream sections are collapsed.

The section headers for the 6 audio streams each show a summary of the current configuration, displaying the number of channels and destination IP address(es). This makes it easy to view the configuration of all audio streams together, in a table-like format. Click on a header to open that section to see the menus for that audio stream.



When a section is opened, the parameters for the audio stream can be configured.

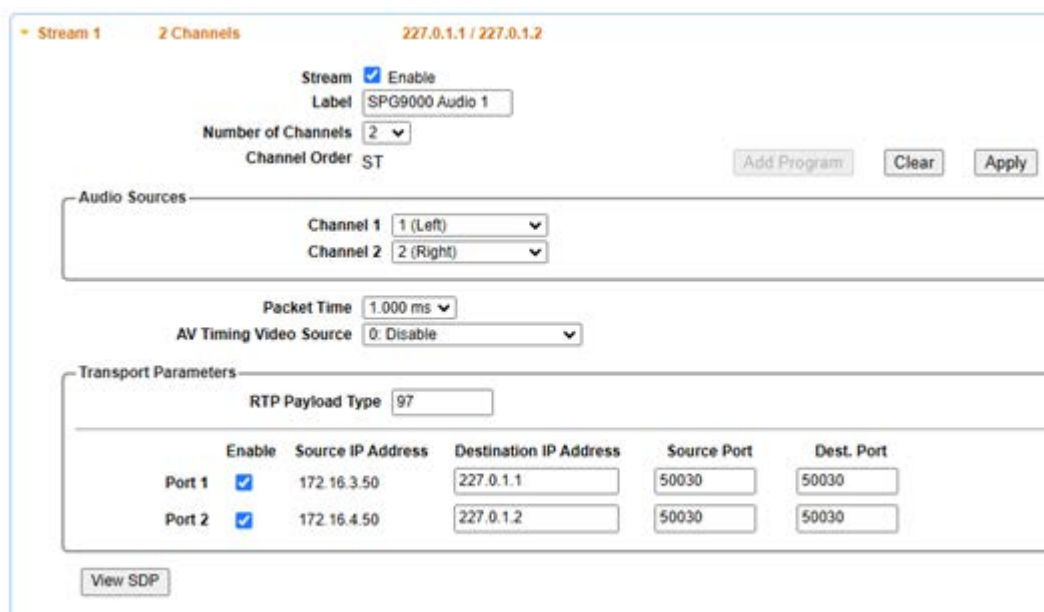

Data Streams

Select **Data Streams** to configure ST 2110-40 ancillary data streams. When the section is first opened, the six individual data stream sections are collapsed.

The section headers for the 6 data streams each show a summary of the current configuration, displaying the time code format, time code source and destination IP address(es). This makes it easy to view the configuration of all data (time code) streams together, in a table-like format. Click on a header to open that section to see the menus for that data stream.

▼ Data Streams

▶ Time Code 1	30 fps drop-frame	Local (DST)	227.0.1.1 / 227.0.1.2
▶ Time Code 2	24 fps	Program Time	227.0.2.1 / 227.0.2.2
▶ Time Code 3	Disabled		
▶ Time Code 4	Disabled		
▶ Time Code 5	Disabled		
▶ Time Code 6	Disabled		

When a section is opened, the parameters for the data stream can be configured.

▼ Time Code 1 30 fps drop-frame Local (DST) 227.0.1.1 / 227.0.1.2

Stream Enable
 Label
 ATC Type
 Source
 Offset
 Time Code Format

Associated Video Format

Frame Height lines
 Scan Type
 Field Rate fps

Timing

Vertical Delay lines
 Horizontal Delay μs

Transport Parameters

RTP Payload Type

	Enable	Source IP Address	Destination IP Address	Source Port	Dest. Port
Port 1	<input checked="" type="checkbox"/>	172.16.3.50	<input type="text" value="227.0.1.1"/>	<input type="text" value="50040"/>	<input type="text" value="50040"/>
Port 2	<input checked="" type="checkbox"/>	172.16.4.50	<input type="text" value="227.0.1.2"/>	<input type="text" value="50040"/>	<input type="text" value="50040"/>

Front-Panel Menu for IP Streams

To use the front panel of the SPG9000 for this process, press SYSTEM and then select the NETWORK option. See [Menu Operations](#) for details of using the front-panel menus. The table shows the NETWORK menu, and submenus for IP 1 and IP 2.

IP :

VIDEO STREAMS :

VIDEO 1 :

(ENABLE)

LABEL

SOURCE

PACKING MODE

TR OFFSET MODE

TR OFFSET

RTP PAYLOAD TYPE

IP 1 :

(ENABLE)

DEST ADDRESS

SOURCE PORT

DEST PORT

IP 2 :

Same menu and submenus as IP 1

VIDEO N :

Same menu and submenus for streams 1 to 6

AUDIO STREAMS :

AUDIO 1 :

(ENABLE)

LABEL

NUM CHANNELS

CHANNEL ORDER

CHANNEL 1 SOURCE

CHANNEL N SOURCE

Additional menus per NUM CHANNELS value

PACKET TIME

RTP PAYLOAD TYPE

IP 1 :

Same menu and submenus as IP 1

(ENABLE)

DEST ADDRESS

SOURCE PORT

DEST PORT

IP 2 :

Same menu and submenus as IP 1

AUDIO N :

Same menu and submenus for streams 1 to 6

DATA STREAMS :

TIME CODE 1 :

(ENABLE)

LABEL

TYPE

SOURCE

OFFSET

FORMAT	
FRAME HEIGHT	
SCAN TYPE	
FRAME RATE	
DELAY (Vertical)	
DELAY (Horizontal)	
RTP PAYLOAD TYPE	
IP 1 :	
(ENABLE)	
DEST ADDRESS	
SOURCE PORT	
DEST PORT	
IP 2 :	Same menu and submenus as IP 1
TIME CODE N :	Same menu and submenus for streams 1 to 6

Configuration Settings for IP Streams

Configure the specific IP stream:

On the web interface, select the **IP** tab, select the stream type (Video, Audio, or Data), and select the specific stream section to configure.

To use the front panel for this process, see [Front-Panel Menu for IP Streams](#).

Each ST 2110 stream includes Transport Parameters for configuration of IP, UDP and RTP packet headers. Video, audio, and data stream each also have type-specific configuration parameters.

Every IP stream has a Session Description Protocol (SDP) object that can be viewed from the web interface and copied to external ST 2110 connection management systems.

Transport Parameters

The Transport Parameters include the source and destination information for the stream.

Transport Parameters

RTP Payload Type

	Enable	Source IP Address	Destination IP Address	Source Port	Dest. Port
Port 1	<input checked="" type="checkbox"/>	192.168.2.30	<input type="text" value="229.0.1.1"/>	<input type="text" value="50020"/>	<input type="text" value="50020"/>
Port 2	<input checked="" type="checkbox"/>	192.168.2.40	<input type="text" value="229.0.1.2"/>	<input type="text" value="50020"/>	<input type="text" value="50020"/>

RTP Payload Type

Enter the value of the Payload Type (PT) inserted into the RTP header for transmitted packets. The ST 2110-10 specification limits the range of payload type values to 96–127.

Port 1 and Port 2 Enable

Select to enable the port for this stream. When both ports are enabled, the same RTP header and payload is transmitted on a packet from each interface, thereby creating a redundant path for the stream per ST 2022-7. The IP and UDP headers are configured independently.

Source IP Address

Displays the source IP address for the respective port. This is a read-only value; see [Configuration Settings for IP Network Interfaces](#) to update the port address parameters.

Destination IP Address

Enter the four octets of the IPv4 address, in dotted decimal notation. On the front panel interface, an edit menu (see [Edit Menus](#)) is used to enter the address, using three digits for each octet with leading zeros if necessary. For example, an address displayed as 229.0.1.1 on the web interface appears as 229.000.001.001 on the front-panel interface.

The SPG9000 supports multicast destination addresses in the range 224.0.2.0 to 239.255.255.255.

Source Port

Enter the source UDP port number as an integer in the range 0-65535. Port numbers in the dynamic or private range (from 49152 to 65535) are typically used for ST 2110 networks.

Dest. Port

Enter the destination UDP port number, as an integer in the range 0–65535.

Note: If NMOS is enabled, the destination IP address and the source and destination UDP port numbers may be updated by the connection manager, depending on configuration values set from that external application. See [NMOS Services](#). The source IP address cannot be updated via NMOS, and can only be changed by SPG9000 network interface settings.

Video Streams

The Stream sections are used to configure the video-specific options for each ST 2110-20 video stream.

▼ Stream 1 Plain Bars 1920x1080 29.97p 227.0.1.1 / 227.0.1.2

Stream Enable

Label SPG9000 Video 1

Video Source 1: Plain Bars (1.3276 Gbps) ▼

Packing Mode General ▼

TR_OFFSET Default ▼ 1275 µs

Stream

Select to enable the stream. When a stream is enabled, it is included in the Port Utilization calculations. At least one port also needs to be enabled for packets to be transmitted.

Label

Enter a user-defined label to identify the IP video stream. The stream label is used in the IS-04 sender object in the NMOS Node API, and as the session name ("s=" field) in the SDP object for the stream. See [NMOS API](#) and [Session Description Protocol](#).

Video Source

Select the video source for this IP stream. The video source defines the format, test signal content and timing parameters. See [Configuration Settings for Video Sources](#) to change these parameters.

The menu shows all 6 video sources, but some sources may be unavailable for selection if there is insufficient bandwidth for this stream. Use the estimated bandwidth of the stream and the Port Utilization graph to check if the stream can be enabled.

Note: If the selected video source changes format such that the new bandwidth for the stream would cause the port to be over-subscribed, the stream will automatically be disabled.

If any video source 1-4 is used for a Level B 3G-SDI signal, that source cannot be used for a video IP stream. Select Level A instead. See [Configuration Settings for SDI Outputs](#).

Packing Mode

Select General Packing Mode (GPM) or Block Packing Mode (BPM) for the video stream. These modes are defined in the ST 2110-20 specification. General Packing Mode attempts to make packets which are close to the UDP size limit of 1460 octets. Block Packing Mode uses a video payload size of 1260 octets, which is an integer multiple of 180-octet "blocks". General Packing Mode is slightly more efficient, and will have a lower bandwidth estimate for the stream.

TROFFSET

The TROFFSET value is defined in the ST 2110-21 specification in the context of the Packet Read Schedule. It represents the time (in microseconds) from the virtual start of the video frame to the time at which the receiver is expected to start reading packets from its internal buffer. The SPG9000 uses the narrow sender model (Type N), which uses the gapped PRS. This approximates the delivery of sample data to an SDI signal.

Select Default to choose the format-specific default value of TROFFSET for the stream. Select Manual to select a user-specified value.

Audio Streams

The Stream sections are used to configure the audio-specific options for each ST 2110-30 audio stream.

Stream

Select to enable the stream. At least one port also needs to be enabled for packets to be transmitted.

Label

Enter a user-defined label to identify the IP audio stream. The stream label is used in the IS-04 sender object in the NMOS Node API, and as the session name ("s=" field) in the SDP object for the stream. See [NMOS API](#) and [Session Description Protocol](#).

Number of Channels

Select the number of channels for the stream. The SPG9000 supports 1, 2, 4, 6, 8, or 16 channels per each audio stream.

Channel Order

The channel order is a string that appears in the Session Description Protocol (SDP) object for the audio stream, to signal how the set of channels in the stream should be interpreted by the receiver. The string is composed from a set of specific symbols defined in the ST 2110-30 specification.

Use the buttons to construct the string from start to end:

Add Program: Append the selected channel grouping symbol from the pull-down menu to the end of the channel order string. The pull-down menu will only show available channel groupings based on the number of channels for the stream and the remaining channel count. For example, if the stream has 4 channels and the channel order string is empty, the pull-down menu will show all groupings with 4 or fewer channels. If Standard Stereo (2 channels) is selected and the Add Program button is pressed, the "ST" symbol will be added to the string and the pull-down menu will then show available channel groupings of 2 or fewer channels. If Mono (1 channel) is then selected and the Add Program button is pressed again, the "M" symbol is appended to the string and the pull-down menu will show Mono as the only remaining grouping for the one remaining channel.

Clear: Press the button to reset the channel order string to an empty string. The default channel order is "Unn" (where nn is the number of channels for the stream) to indicate an undefined grouping. Clear the string first to replace this symbol with the desired grouping(s).

Apply: Press the button to complete the channel order string. If any unused channels remain, the "Unn" symbol will be appended to the string for those channels.

Audio Sources

Select the audio source for each channel in the audio stream. See [Configuration Settings for Audio Sources](#) to change the tone frequency, amplitude, and other settings for each audio source.

Any audio source can be used for any audio channel, and the same source can be used for multiple channels in multiple streams. Changing a source setting will affect all SDI and IP outputs that use that source.

Packet Time

Select the packet time for audio sample data. The SPG9000 supports packet times of 1 ms or 125 μ s. For 48 kHz sampling, a packet time of 1 ms corresponds to 48 audio samples per channel per RTP packet, and an IP packet rate of 1000 packets per second. A packet time of 125 μ s corresponds to 6 audio samples per channel per packet and a rate of 8000 packets per second. Due to the overhead of the Ethernet, IP, UDP and RTP layers, the 1 ms packet time uses less bandwidth, but fewer channels per packet are available.

Note: When the Number of Channels is set to 16, the packet time is forced to 125 μ s because there are too many channels to fit into a single packet at 1 ms.

AV Timing Video Source

Select the video source that will be used with this audio stream for AV Timing mode. The video source must also have AV Timing Mode enabled. See [Configuration Settings for Video Sources](#). When both the video source and the audio stream are enabled for AV

Timing Mode, the “flash/pop” effect will be synchronized between all IP video streams that use the selected video source and for this IP audio stream.

Data Streams

The Stream sections are used to configure the data-specific options for each ST 2110-40 data stream. The SPG9000 supports ancillary time code (ATC) in IP data streams.

Time Code 1 30 fps drop-frame Local (DST) 227.0.1.1 / 227.0.1.2

Stream Enable

Label

ATC Type

Source

Offset

Time Code Format

Associated Video Format

Frame Height lines

Scan Type

Field Rate fps

Timing

Vertical Delay lines

Horizontal Delay μs

Stream

Select to enable the stream. At least one port also needs to be enabled for packets to be transmitted.

Label

Enter a user-defined label to identify the IP data stream. The stream label is used in the IS-04 sender object in the NMOS Node API, and as the session name (“s=” field) in the SDP object for the stream. See [NMOS API](#) and [Session Description Protocol](#).

ATC Type

Select the type of ancillary time code. ATC_LTC is typically used with progressive scan video formats and sends one time code value per video frame. ATC_VITC is used with interlaced scan video formats and sends one time code value per video field (two packets per frame).

Source

Select the time source for the time code counter:

Local (DST): Use the main time-of-day and the time zone offset and the daylight saving time offset to compute the local time.

Local (No DST): Use the main time-of-day and the time zone offset, but exclude any daylight saving time offset to compute the local time.

UTC: Use Coordinated Universal Time instead of a local time.

Program Time: Use the program time counter instead of a time-of-day value. See [Program Time Counter](#).

The ATC data includes the hours, minutes, seconds, and frames digits (HH:MM:SS:FF) according to ST 12-1 and the year, month, day, and time zone information according to ST 309.

Offset

Enter a time offset (hours, minutes, seconds, and frames) relative to the selected source time. For example, you could use the time code for a different time zone than the system normal time zone by specifying an offset of ± 1 or more hours.

Time Code Format

Selects the time code format and frame rate.

The ATC format refers to the allowed range of digits for the frame count, along with the method in which they are counted and roll over at the end of each second. For example, 24 fps time code counts frames from 00 to 23 each second, and then rolls over back to 00. 30 fps drop-frame time code counts frames from 00 to 29 in most seconds, but skips the 00 and 01 counts at specific times. See [Daily Jam Sync](#).

Select one of the ATC formats:

24 fps

25 fps

30 fps

30 fps drop-frame

Associated Video Format

Unlike SDI, in which ancillary data is carried in the same signal as frames of video, ST 2110-40 streams are completely independent from ST 2110-20 video streams. However, a time code data stream needs to be synchronized with a virtual video stream with a compatible format so that the packets arrive at the receiver at the time at which they would appear within the SDI ancillary data space. This requires a partial video format configuration for the data stream.

Frame Height

Select the number of lines of the associated video format. The number of active lines and total lines (including vertical blanking) are both shown for each option.

Scan Type

Select Progressive or Interlaced scan.

Frame Rate

Select the frames per second for the associated video. Available options for this menu correspond to the selected Time Code Format. For example, if 30 fps drop-frame format is chosen, only 29.97 and 59.94 fps frame rates are available.

Timing

The Timing settings adjust the timing offset of the time code stream relative to the internal frame reset. See [Epoch-Based Synchronization](#) to understand how frame resets are synchronized with respect to the reference source.

The total timing offset is a combination of whole lines (vertical delay) and partial lines (horizontal delay). A negative value means the internal clock is advanced relative to the frame reset.

Vertical Delay

Enter an integer number of lines, in 1 line increments. The delay range is from $-1/2$ to $+1/2$ frame.

Horizontal Delay

Enter the delay value in microseconds. The timing adjustment range is ± 1 line, where the line length depends on the selected frame height and frame rate.

Session Description Protocol

Each IP stream has an associated Session Description Protocol (SDP) object. The SDP object is a series of lines of text that include format information and connection (transport) parameters so that the receiver can correctly process the stream of packets. SDP fields and attributes are defined in RFC 8866 and are further extended and constrained by ST 2110 standard documents.

When a stream is disabled, the SDP object is undefined. When enabled, the SDP object is created. Any subsequent changes to the stream parameters or the video, audio, or data sources will cause the SDP object to be updated immediately.

The SDP object can be viewed from the web interface. Within each Stream configuration section, click the **View SDP** button to open the panel.

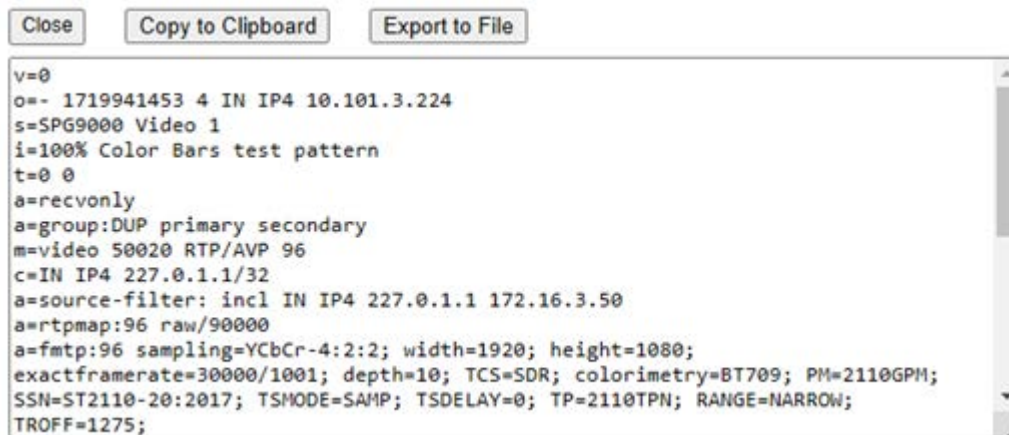

```
v=0
o=- 1719941453 4 IN IP4 10.101.3.224
s=SPG9000 Video 1
i=100% Color Bars test pattern
t=0 0
a=recvonly
a=group:DUP primary secondary
m=video 50020 RTP/AVP 96
c=IN IP4 227.0.1.1/32
a=source-filter: incl IN IP4 227.0.1.1 172.16.3.50
a=rtpmap:96 raw/90000
a=fmtp:96 sampling=YCbCr-4:2:2; width=1920; height=1080;
exactframerate=30000/1001; depth=10; TCS=SDR; colorimetry=BT709; PM=2110GPM;
SSN=ST2110-20:2017; TSMODE=SAMP; TSDELAY=0; TP=2110TPN; RANGE=NARROW;
TROFF=1275;
```

The panel can be resized by grabbing and moving the bottom right corner.

Press **Copy to Clipboard** to copy the text to the clipboard so that you can paste it into another application, such as a ST 2110 connection manager.

Press **Export to File** to open a dialog to save the file to a location on your computer.

Note: The SDP objects can also be read programmatically using the `/ip/video/{stream}/transportfile`, `/ip/audio/{stream}/transportfile` and `/ip/time-code/{stream}/transportfile` endpoints in the application programming interface. See [HTTP API](#).

System Maintenance

This section describes how to maintain the SPG9000 system functionality, including how to:

- operate with dual power supplies,
- upgrade the instrument with new licensed features,
- upgrade the instrument firmware,
- generate a service report for the system when requested by Telestream technical support, and
- calibrate the internal oscillator.

This section also documents the security considerations when using the SPG9000 in your network.

Power Supply Monitoring and Replacement

This section describes how the SPG9000 operates with one or two power supply modules, how to check the status of the power supplies, and how to replace a power supply module if necessary.

Dual Power Supply Operation

When ordered with option SPG9000-SPW, the instrument has one power supply module installed. When ordered with option SPG9000-DPW, two power supply modules are installed. With two power supply modules installed in the instrument, one operates as the active supply and the other is a backup supply. Power is only drawn from the active power supply and the backup supply remains idle. This ensures that the two supplies do not age at the same rate. Once each day, the system automatically performs a load test on the backup supply.

If the active power supply fails, the system automatically switches to the backup supply, which becomes the new active supply. This switch is instantaneous so power to the instrument is uninterrupted. You can remove and replace a failed supply without having to remove the instrument from operation. See [Hot-Swap Power Supply Module](#).

Temperature-Weighted Hours

The instrument keeps track of the age of each power supply module by calculating a metric of temperature-weighted hours (TWH). When the operating temperature is

25 °C or cooler, the power supply module is expected to last 15 years. At the maximum operating temperature of 50 °C, the expected life of the supply decreases to only 5 years.

Every hour, the instrument measures the temperature and updates the TWH total for each power supply. The active supply operates at a warmer temperature than the backup supply so the TWH of the active supply increases faster than the TWH of the backup supply. When the TWH value reaches 131400 hours, the associated PWR 1 or PWR 2 indicator on the front panel changes to orange to indicate the power supply should be replaced.

Preferred Power Supply

When two power supply modules are installed, one can be selected as the preferred power supply. The preferred power supply is the active supply if possible.

The system keeps track of the most recent load test result for each power supply. When the system first powers on, new test results are required, so the active power supply may not be the preferred power supply until each power supply has been tested and passes.

The recommended usage strategy is to configure one supply as preferred and use the second supply only in case the first supply has a failure. This strategy allows the backup supply to have the maximum remaining life when it is needed.

The preferred supply configuration is not saved as part of the preset system, so it does not change when you activate any of the system presets, including the Factory Default preset. See [Presets](#).

Web Interface for Power Supplies

To use the web interface of the SPG9000 to select a preferred power supply:

1. On the web interface, click **Status**.
2. In the System section, select the Preferred Power Supply option.



Front-Panel Menu for POWER SUPPLY

To use the front panel of the SPG9000 for this process, press **SYSTEM** and then select the **POWER SUPPLY** option. See [Menu Operations](#) for details of using the front-panel menus.

The table shows the submenus for the POWER SUPPLY menu.

SYSTEM :
PRESET :
INFO :
NETWORK :
FRONT PANEL :
WEB :
GENERAL PURPOSE INTERFACE :
POWER SUPPLY :
PREFERRED
LOAD TEST
FIRMWARE UPGRADE
CALIBRATE OVEN
DIAGNOSTICS

Load Test

One time every 24 hours the backup power supply undergoes a load test—a load test is run when the instrument is turned on and every 24 hours from that time. The backup supply, which normally runs as a powered standby, has a load applied to it, similar to that of the operating instrument, for several seconds. The voltage is measured to check if it is within tolerance for the expected 12 V value. The load test results are reported on the Status tab of the web interface.

If the load test passes, that power supply can be selected as the preferred supply. The system switches the preferred supply to active if possible. Depending on which power supply starts first when the system is powered up, the preferred supply may not be used as the active supply until the first successful load test (either manually or scheduled).

Manually Start Load Test

- On the web interface:
 - A. Click the **Status** tab, and in the System section at the bottom of the page, below the list of power supplies, click **Show Details** to open the power supply status.
 - B. Click **Load Test PS#**.

Note: The load test can only be performed on the backup supply.

- On the front-panel interface:
 - A. Go to the SYSTEM : POWER SUPPLY : LOAD TEST menu.
 - B. Follow the instructions on the front panel.

Change Preferred Power Supply

If a second power supply is not available, connect one. See [Hot-Swap Power Supply Module](#).

- On the web interface:
 - A. Click the **Status** tab, and in the System section at the bottom of the page, below the list of power supplies, click **Show Details** to open the power supply status.
 - B. In the Preferred Power Supply menu, select the backup power supply. If the backup power supply has had a recent successful load test, the instrument will switch the power supply set as preferred to active.

Note: A successful load test on the backup power supply is required before the instrument will change the power supply.

- C. If the power supply does not switch, check for a recent successful load test. If no load test is recorded (for example on a recently installed power supply), run a load test. See [Manually Start Load Test](#).
- On the front-panel interface:
 - A. On the front-panel interface, go to the SYSTEM : POWER SUPPLY : PREFERRED menu.
 - B. Select the other power supply as preferred. If the backup power supply has had a recent successful load test, the instrument will switch the power supply set as preferred to active.
 - C. If the power supply does not switch, run a load test (for example on a recently installed power supply). See [Manually Start Load Test](#).

Power Supply Status

The status of each power supply module can be viewed from the front or rear of the instrument. On the front panel, the PWR 1 and PWR 2 indicators illuminate in different colors to show the status of the power supply modules. The rear panel of each power supply module has a STATUS indicator that matches the status shown on the PWR 1 and PWR 2 front-panel indicators. See [PWR 1 and PWR 2](#).

To see more detailed information on the web interface:

1. On the web interface, click the **Status** tab.
2. In the System section at the bottom of the page, click **Show Details**.

The information for the power supplies status appears. A table shows the voltage measurement, usage data (active, standby, and temperature-weighted hours) and the load test history.

System

Hardware Status **OK**

Show Details

Power Supplies **OK**

Active Power Supply **PS2**

Preferred Power Supply **Power Supply 2** ▼

Hide Details

	Power Supply 1	Power Supply 2 (Active)
Voltage (+12V)	11.99 V (OK)	11.88 V (OK)
Active Hours	4069	3770
Standby Hours	303	969
Temp Weighted	4942 (OK) (limit: 131400)	4739 (OK)(limit: 131400)
Manufacture Date	2023-03-15 13:55:14 (UTC)	2023-03-15 14:36:35 (UTC)

Load Test PS1

	Load Test History	
Last Test	2023-08-15 06:53:53 (UTC)	2023-08-15 06:55:56 (UTC)
Pass	17	172
Fail	0	0
Last Pass	2023-08-15 06:53:53 (UTC)	2023-08-15 06:55:56 (UTC)
Last Fail	n/a	n/a

Hot-Swap Power Supply Module

This procedure describes how to replace a power supply module while the instrument is in operation. To hot-swap a power supply module:



WARNING: Disconnect the power cord from the power supply module before you remove the module from the instrument. Also, do not connect a power cord to the power supply module while the module is not installed in the instrument. There are dangerous high voltages inside the module when the power cord is connected.



CAUTION: To prevent an unexpected shutdown of the instrument, be sure to disconnect the correct power cord if you are replacing a faulty power supply module.

When viewed from the front of the instrument, Power Supply 1 is the left power supply module and Power Supply 2 is the right power supply module. This matches the orientation of the PWR 1 and PWR 2 indicators on the front panel. The STATUS indicator on the rear panel of each power supply module matches the status shown by the front-panel PWR 1 and PWR 2 indicators.

1. Remove the power cable from the power supply module that you are removing or replacing.

2. Pull out the handle located at the bottom of the supply.

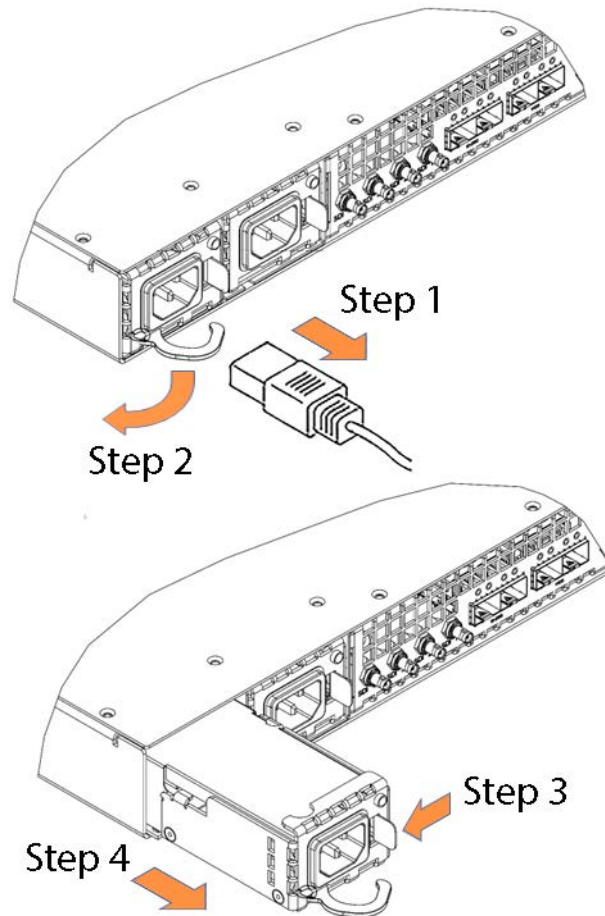

3. Push the retaining latch to the left and hold.
4. Use the handle to pull the power supply module out of the instrument (release the retaining latch when the latch clears the instrument).
5. Insert the replacement supply into the instrument until it latches into place.
6. If necessary, push the handle of the supply into the storage position.
7. Connect the power cable to the power supply module you installed.
8. Check that the status of the power supply module you just installed is bright or dim green.
9. If needed, change the preferred supply configuration. See [Change Preferred Power Supply](#).

We recommend you configure the supply with the most TWH to be used as the primary preferred supply. This allows for the newer supply to be preserved so it can provide the best possible backup if the primary supply fails.

Licensed Features

The SPG9000 has several features that are available when the corresponding license is enabled. Licenses are preinstalled on the system if they are purchased at the same time as the base unit. Licenses can also be added at any later time by purchasing them as upgrades.

There are four licensed options for the SPG9000:

SPG9000-GNSS: This enables the internal GNSS receiver and its associated time synchronization features. This licensed is required to view the GNSS signal status on the Status tab of the web interface and the STATUS : GNSS menu of the front-panel interface. The license is also required to configure the GNSS Receiver settings from the Reference tab of the web interface and the REFERENCE : GNSS RCVR menu of the front-panel interface.

SPG9000-PTP: This enables the PTP instances associated with the network interfaces labeled as PTP 1 and PTP 2. This license is required to view the PTP 1 and PTP 2 status on the Status tab of the web interface and the STATUS : PTP 1 and PTP 2 menus of the front-panel interface. The license is also required to configure the two instances from the PTP tab of the web interface and the PTP button on the front-panel interface.

SPG9000-SDI: This enables the SDI outputs for test signal generation. This license enables the Video, Audio (tones), and SDI tabs of the web interface and the VIDEO, AUDIO : TONES, and SDI menus of the front-panel interface.

SPG9000-IP: This enables the IP ports for test signal generation. This license enables the Video, Audio (tones), and IP tabs of the web interface and the VIDEO, AUDIO : TONES, and IP menus of the front-panel interface.

View Installed Licenses

Check the installed Licenses to find details of the licenses. This includes what licenses have been purchased, when they expire, and their uses.

Web Interface for Licensed Options

To use the web interface, select the **System** tab and then select **System Information**.

The Expiration column in the Licensed Options table shows if the license is Permanent, Not Installed, or has a specific expiration date.

Licensed Options		
	Expiration	Description
SPG9000-GNSS	Permanent	Enable internal GNSS receiver and time synchronization features
SPG9000-PTP	Permanent	Enable PTP (IEEE 1588) support on two ports
SPG9000-SDI	2023-07-31	Enable SD/HD/UHD test signal generation on four SDI outputs
SPG9000-IP	Not Installed	Enable ST 2110 test signal generation on two IP ports

Update Licenses

Front-Panel Menu for LICENSED OPTIONS

To use the front panel, press **SYSTEM**, then select the **INFO** option, and then select **LICENSED OPTIONS**. See [Menu Operations](#) for details of using the front-panel menus.

The table shows the submenus for the INFO menu.

SYSTEM :
PRESET :
INFO :
VERSIONS
LICENSED OPTIONS
HOST ID
SERIAL NUMBER
NETWORK :
FRONT PANEL :
WEB :
GENERAL PURPOSE INTERFACE :
POWER SUPPLY :
FIRMWARE UPGRADE
CALIBRATE OVEN
DIAGNOSTICS

Install New Licenses

When you purchase a licensed option, you receive a Software Serial Number from Telestream. This string is associated with this specific SPG9000 instrument, as identified by the Host ID and (hardware) Serial Number listed at the top of the license application information. The Software Serial Number is a set of 20 digits and letters such as SG7J-U6E8-2S4F-UQRJ-6CL2.

1. In the SPG9000 web page, select the **System** tab and then select **System Information**.
2. Under the Licensed Options table, select **Update Licenses**. The Update Licenses panel opens.

Host ID SPG-FA2BAM2LTVY4AR6A8PPCAAJ54U
Serial Number S010110

1. Locate the Software Serial Number in the email message from Telestream and enter it here:
2. Get the Activation Code for this SPG9000 system.
 ⇒
3. Go to the Telestream Offline Activation Site at <https://cws.telestream.net/offlineactivation.aspx> and submit this code.
4. Open the license file that was downloaded to your browser.
 No file chosen
5. Review the new licensed options and apply if ok.

3. Enter the Software Serial Number in the first field.

4. Select **Get Activation Code**.

The activation code appears in the next field.

5. Select **Copy to Clipboard**.

6. Select the link to the Telestream Offline Activation Site (<https://cws.telestream.net/offlineactivation.aspx>). If the SPG9000 is not on a network connected to the outside Internet, you will have to manually transfer the activation code to another computer.

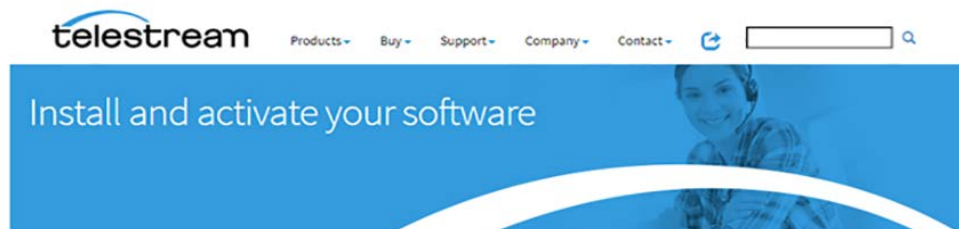

Offline Activation Code

7. Paste the activation code into the text box and select **Submit**.

Your browser prompts you to save a file named "TelestreamLicense."

If the SPG9000 is not on a network connected to the Internet, you will have to transfer this file to a computer that is connected to the SPG9000.

Note: This process is the only time the SPG9000 needs to access the Internet.

8. Save the TelestreamLicense file.
9. In the SPG9000 web page, select **Choose File** and select the TelestreamLicense file.
The license file is checked and a summary of its contents is displayed in the last text box on the web page, as in the sample:

```
Host ID: SPG-FA2BAM2LTVY4AR6A8PPCAAJ54U

Licenses:
SPG9000-SPG9000
SPG9000-GNSS
SPG9000-PTP
```

If the Host ID matches the SPG9000 and the set of licenses is correct, the Apply Licenses button becomes available.

10. Select **Apply Licenses**. The table at the top of the web page is updated and any new features are now available.

Note: The SPG9000-SPG9000 license code in the TelestreamLicense file contents refers to the base unit and is always present in the license file, but it is not in the optional license table.

Upgrade Instrument Firmware

Telestream releases software and firmware updates for products to add new features and to fix product problems. You can find the latest firmware for your product at the Telestream website: www.telestream.net/video/resources.htm#Software and select *Signal and Synchronization Generators*.

Check Current Firmware Version

You can check the current version of the instrument firmware by looking at the Version number on the right of the banner of the web interface. The version number consists of two or three numbers separated by periods:

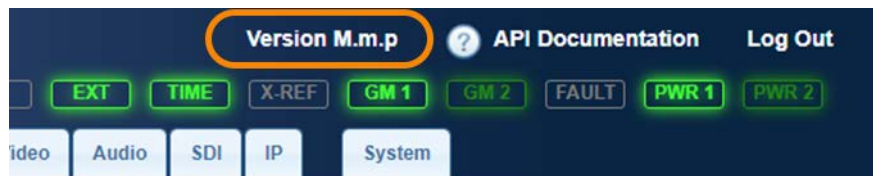

- Major version number (M) indicates a significant change from the previous major release.
- Minor version number (m) indicates several new features since the previous major or minor release.
- Patch version number (p) indicates defect fixes from the previous release. The patch version number is not always present.

Web Interface for Hardware and Software Versions

More version information (for software components, hardware board versions, etc.) is available on the web interface.

On the web interface, click the **System** tab, and then click **System Information**.

Hardware and Software Versions	
Firmware	4.0
Firmware Date	2024-08-29 21:36:10
Firmware Build	2856
PTP Manager	2.07
PTP4L	4.3-00168-g90a09b9
NMOS Library	1.0-07b20a1
Main Board	1.0
Reference I/O Board	3.12
TSG Board	2.48.1
GNSS Receiver	3100-1.02

Front-Panel Menu for INFO

More version information is available through the front-panel interface.

Press **SYSTEM** and then select the **INFO** option. See [Menu Operations](#) for details of using the front-panel menus.

The table shows the submenus for the INFO menu.

SYSTEM :

PRESET :

INFO :

VERSIONS

LICENSED OPTIONS

HOST ID

SERIAL NUMBER

NETWORK :

FRONT PANEL :

WEB :
GENERAL PURPOSE INTERFACE :
POWER SUPPLY :
FIRMWARE UPGRADE
CALIBRATE OVEN
DIAGNOSTICS

Upgrade Firmware from Front Panel

The SPG9000 firmware can be upgraded by copying the new firmware package to a USB memory device and installing it from the front-panel USB port.

SYSTEM :

PRESET :
INFO :
NETWORK :
FRONT PANEL :
WEB :
GENERAL PURPOSE INTERFACE :
POWER SUPPLY :
FIRMWARE UPGRADE
CALIBRATE OVEN
DIAGNOSTICS

Note: The time required to complete the firmware upgrade is about 10-25 minutes, depending on the contents of the new firmware. After the upgrade has completed, you should refresh the browser if you use the web interface. Press Ctrl-F5 in most browsers.



CAUTION: The instrument will automatically reboot one or more times during the upgrade process. Do not upgrade the instrument while the instrument is in use as a sync reference. When the instrument has started to erase the internal flash, do not remove power from the instrument.

To upgrade the system firmware:

1. On a computer with an Internet connection, go to <https://www.telestream.net/video/resources.htm>.
2. In the Software & Downloads section, select **Signal and Synchronization Generators**.
3. Select the current firmware release for the SPG9000.
A .zip file is downloaded to the local drive.
4. Open the .zip file and extract the firmware file.

5. Rename the .deb file to spg9000.deb. If the file does not have this specific title, the instrument cannot find it.
6. Insert a USB memory device into a USB port in the computer containing the latest instrument firmware.
7. Open the USB device to view its file contents.
8. On the USB device, create a folder named SpgUpgrd.
9. Open the SpgUpgrd folder and copy the spg9000.deb file to the USB device. The USB device should have a directory path of SpgUpgrd\spg9000.deb.
10. Eject and safely remove the USB device from the computer.
11. Insert the USB device into the front-panel USB port on the instrument.
12. On the front panel of the SPG9000, press **SYSTEM**.
13. Select the **FIRMWARE UPGRADE** option and press **ENTER**.
A confirmation message appears.

! Continue with firmware upgrade? !
* Yes : ENTER / No : BACK *

14. Select ENTER to continue with the upgrade or select BACK to cancel the upgrade.
During the upgrade process, the instrument displays messages indicating the upgrade status.

Note: The upgrade process may take approximately 10-25 minutes to complete. The SPG9000 may reboot several times during the process. Do not remove power until the process has completed.

15. After the firmware upgrade, remove and reconnect the power cables. This forces a hard power cycle.
16. After the upgrade is complete, remove the USB device.

Upgrade Firmware from Web Interface

The SPG9000 firmware can be upgraded by uploading the new firmware package to the instrument and installing it from the web interface.

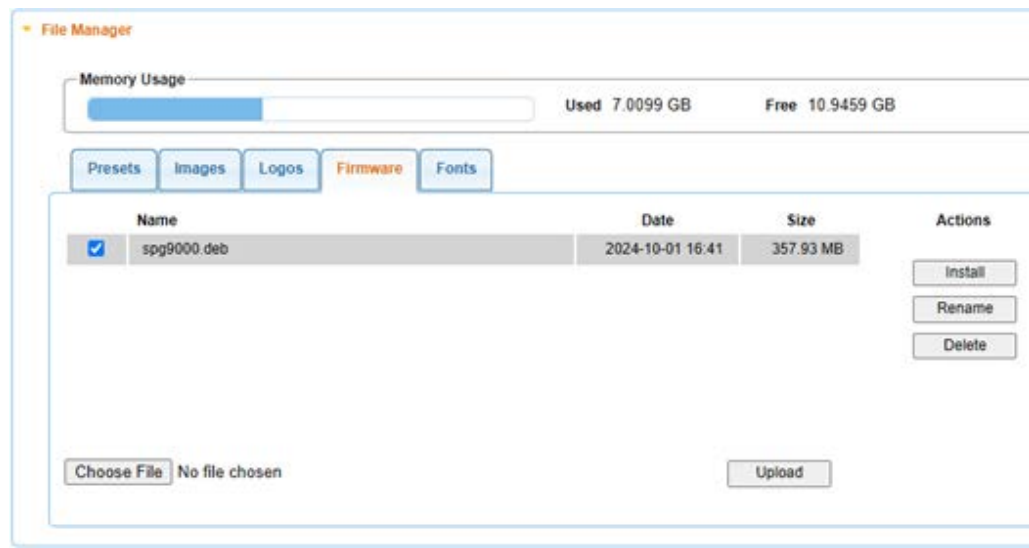

Note: The time required to complete the firmware upgrade is about 10-25 minutes, depending on the contents of the new firmware. After the upgrade has completed, you should refresh the web browser. Press Ctrl-F5 in most browsers.

CAUTION: The instrument will automatically reboot one or more times during the upgrade process. Do not upgrade the instrument while the instrument is in use as a sync reference. When the instrument has started to erase the internal flash, do not remove power from the instrument.

To upgrade the system firmware:

1. On a computer with an Internet connection, go to <https://www.telestream.net/video/resources.htm>.
2. In the Software & Downloads section, select **Signal and Synchronization Generators**.
3. Select the current firmware release for the SPG9000. A .zip file is downloaded to the local drive.
4. Open the .zip file and extract the firmware file.
5. On the web interface, click the **System** tab and then click **File Manager**.
6. Select the **Firmware** tab in the File Manager.
7. Select **Choose File**.
8. Locate the file saved in step 4 and select **Open**.
9. Select **Upload**. The firmware file will commence uploading to the firmware folder on the SPG9000. This may take up to several minutes, and a progress bar will be displayed.

10. When the file has completely uploaded (and the progress bar disappears), select the file by its checkbox in the leftmost column of the File Manager table.
11. Select **Install**. When prompted to confirm or cancel the upgrade, press **OK**. The upgrade process will start, and you should not interact with the web interface while the upgrade process is in progress.

Note: The upgrade process may take approximately 10-25 minutes to complete. The SPG9000 may reboot several times during the process. Do not remove power until the process has completed.

Service Report

You may have questions about SPG9000 configuration or operation, or you may have issues that require technical support. Please see [Telestream Contact Information](#) for website, email, or phone information.

The technical support team may ask you to generate a Service Report and send it back for their inspection. A Service Report is a package of files containing the complete configuration and status for the instrument.

To generate the Service Report, select the **System** tab of the web interface and then select the **System Information** section.

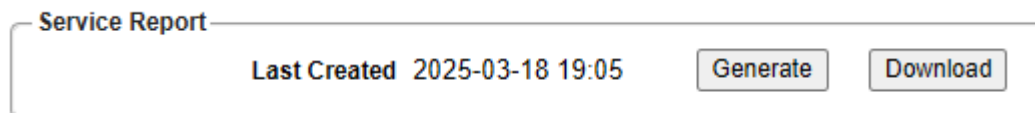

Select **Generate** to create a new Service Report file or to update an existing file. This process will take a few seconds. If a report file had previously been generated, its date and time will be shown. After the file has been generated, select **Download** to copy the file to your computer.

The Service Report is a compressed archive file (ZIP format) that includes the serial number as part of the filename, in case you need to send the report files for multiple SPG9000 systems.

Note: Some browsers may consider .zip files as insecure and block the file download. It is safe to keep these files.

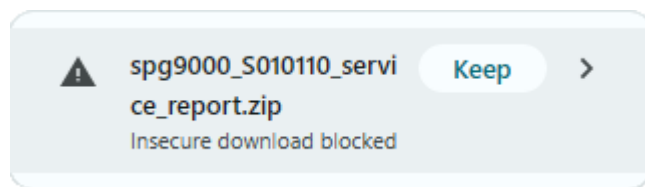

System Oscillator Calibration

Because the oscillator frequency was adjusted accurately at the factory, you should not need to adjust the oven oscillator frequency immediately after the initial installation. However, you can adjust the oscillator frequency at any time to improve the accuracy of the internal frequency.

Calibration might be needed occasionally to compensate for drift in the oven oscillator. The drift is typically greater during the first 30 days of operation. After the first 30 days we recommend using the calibration procedure to check and calibrate the oscillator if appropriate. After that a yearly calibration is typically adequate to maintain good frequency accuracy when in internal mode.

When option SPG9000-GNSS or option SPG9000-PTP is installed, you might be able to improve the accuracy slightly after installation because the instrument is at the normal temperature for your specific installation site. If you intend to use the Internal reference source, recent calibration is recommended. Prior to calibration, the SPG9000 should have a stable lock for a few hours or more to a good external reference such as a GNSS signal or a lab-quality 10 MHz signal.

Note: The calibration can only be done through the front panel.

Do not perform the calibration process when the system is currently locked to the secondary reference. See [Secondary Reference](#). Wait for the system to return to a stable lock to the primary GNSS reference.

Check if the oven oscillator needs to be calibrated:

1. While the instrument is locked to a GNSS signal, a PTP follower, or a precise genlock reference (such as a CW 10 MHz signal from a calibration source), press **SYSTEM**.
2. Select the **DIAGNOSTICS** option. See [Menu Operations](#) for details of using the front-panel menus.

SYSTEM :

PRESET :

INFO :

NETWORK :

FRONT PANEL :

WEB :

GENERAL PURPOSE INTERFACE :

POWER SUPPLY :

FIRMWARE UPGRADE

CALIBRATE OVEN

DIAGNOSTICS

1. Press **ENTER** to view the TUNE submenu.
2. On the first page of the TUNE submenu, there is a status menu similar to:

```
SYSTEM : DIAGNOSTICS : TUNE
Tune: -0.00e-6 (2078823 --> 2078823)
```

3. Press the left or right arrow button to view the second page of the TUNE submenu. There is a status menu similar to:

```
SYSTEM : DIAGNOSTICS : TUNE
Phase: 0x7FFFFFFA DDS: 2078823 Fine
```

4. Verify the second page reads "Fine" not "Coarse".
5. Check if the Tune value is greater than $\pm 0.10e-6$
 - If the value is less than $\pm 0.10e-6$, no calibration is required.
 - If it is greater, calibrate the oven oscillator.
 - i. Press **BACK** to exit the DIAGNOSTICS submenu and select the **CALIBRATE OVEN** option.
 - ii. Press **ENTER** to calibrate the oven oscillator.

Security Considerations

The SPG9000 is designed for secure environments, in accordance with the recommendations in EBU Tech R 143 *Cybersecurity Recommendation for Media Vendors' Systems, Software & Services, Annex B (Media Appliance Security Requirement)*. However, several recommendations require user action.

Users and Passwords

The SPG9000 has user logins for web interface access, a passkey for API usage, and a remote login user for technical support.

Web Interface

The web interface uses a rudimentary form of role-based access control (RBAC) via two dedicated users. The "admin" user has full read/write access and can make any configuration change. The "operator" user has read-only access and can only view system status and configuration, without the ability to make changes.

The default passwords for these accounts when a new system is manufactured are also "admin" and "operator," respectively. It is strongly recommended that these passwords are changed from the defaults. See [Front-Panel Menu for WEB](#) to change both passwords from the front-panel interface. If you forget the web interface password and

cannot login, you can always view the front-panel menu to recover the password. If you have physical access to the system, you are considered to be a trusted user.

The web interface can also be used to change the password for the logged-in user. Select the **System** tab and then select **Management Settings**. Go to the Web Server subsection. The **Web Page Password** refers to either the “admin” user’s password or the “operator” user’s password, whichever was used to log in. The characters are normally obscured by asterisks. Select **View** to enable the text box and edit the password string. Select **Change** to accept the new password from the value in the text box.

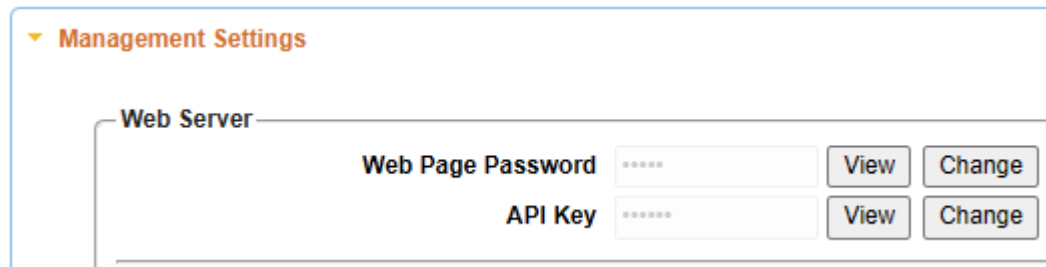

The screenshot shows a web interface with a section titled "Management Settings" (indicated by a downward arrow). Underneath, there is a "Web Server" section. It contains two rows of settings. The first row is for "Web Page Password", which has a text input field filled with asterisks, a "View" button, and a "Change" button. The second row is for "API Key", which also has a text input field filled with asterisks, a "View" button, and a "Change" button.

Note: When you change the web user password from the web page itself, you will be logged out immediately and will have to log in again with the new password.

Strong web passwords can be created, up to 20 characters in length and using the following characters:

- Upper- and lower-case letters A-Z and a-z
- Digits 0-9
- Special characters ! ? @ # & ' () , . - / : ; < > ^
- Space character, except for trailing spaces at the end of the string

API Key

The HTTP API for the SPG9000 requires authentication using the X-API-Key field in the HTTP message header. The factory default for the API key is “apikey”, and it is strongly recommended that the key is changed from this default to a strong password. The API key can be updated from the front panel SYSTEM : WEB : API KEY menu or from the Management Settings section of the web interface. The API key string may be up to 20 characters in length and use any letter or digit character plus any of four special characters: period, hyphen, underline, or tilde.

Remote Login

The SPG9000 has one Linux user account that can only be used by Telestream support staff. The login name and password are never shared with end users. This support account has a password that is unique for that system only. If the password is inadvertently shared or cracked, that password will only work for a single SPG9000 unit.

Network Port Usage

The management interface for the SPG9000 uses several network ports for normal operation. It uses a firewall to block packets received for all other network ports.

Port Number	Transport	Protocol	Application Usage
22	TCP	SSH	Login shell for technical support
53	TCP and UDP	DNS	Requests to the DNS server when resolving fully qualified domain names
67 and 68	UDP	DHCP	Dynamic IP address assignment
80	TCP	HTTP	Default web interface when no certificates are installed
123	UDP	NTP	Network Time Protocol server or client
161	UDP	SNMP	Simple Network Management Protocol for status queries
443	TCP	HTTPS	Secure web interface using SSL certificates
5353	UDP	mDNS	Multicast DNS requests for NMOS discovery
n/a	n/a	ICMP	Internet Control Message Protocol, primarily for "ping" messages to check interface connectivity

Additionally, UDP port 162 is used for sending SNMP TRAP messages, and UDP port 514 is used for sending Syslog messages. TCP port 6514 may be used for sending Syslog messages using TLS. These ports are used for transmit only and are closed for received messages.

The media ports (PTP 1, PTP 2, IP 1, IP 2) have a smaller set of network ports in use:

Port Number	Transport	Protocol	Application Usage
67 and 68	UDP	DHCP	Dynamic IP address assignment
319 and 320	UDP	PTP	Precision Time Protocol

Port Number	Transport	Protocol	Application Usage
n/a	n/a	ICMP	Internet Control Message Protocol, used primarily for “ping” messages to check interface connectivity
n/a	n/a	IGMP	Internet Group Management Protocol, used to join the multicast group address for PTP (224.0.1.129)
n/a	n/a	LLDP	Link Layer Discovery Protocol, used to advertise device and port information to the neighboring switch port

On the media ports, all received ST 2110 (RTP over UDP) packets are discarded by a hardware filter even before the software firewall.